



Product Specification

Revision	V2.0		
Date	2019-01-18		
Model Name	BL-M8723DU1		
Product Name	IEEE 802.11b/g/n (1T1R) WIFI +Bluetooth		
Bilian Approve Field			
Engineer	QC	Sales	
Customer Approve Field			
Engineer	QC	Manufactory	Purchasing

Shenzhen Bilian Electronic Co., Ltd

Address: No 268,Fuqian Rd.,JuTang Community ,Guanlan Town,Baoan District, Shenzhen, 518110,PRC

Homepage: www.b-link.net.cn

Table of Contents

Revision History.....	0
1. Introduction.....	1
1.1 General Description.....	1
1.2 Features.....	1
1.3 Applications.....	1
2. Functional Block Diagram.....	2
3. Product Technical Specifications.....	2
3.1 General Specifications.....	2
3.2 DC Power Consumption.....	3
3.3 RF Specifications.....	4
4. Pin Assignments.....	5
5. Peripheral Schematic Reference Design.....	6
6. Mechanical Specifications.....	7
7. Others.....	8
7.1 Package Information.....	8
7.2 Storage Temperature and Humidity.....	8
8. Typical Solder Reflow Profile.....	8

Revision History

Date	Document Revision	Product Revision	Description
2018/05/21	V1.0	V1.0	Officially released
2019/01/18	V2.0	V2.0	Modification of working temperature range and packing method

1. Introduction

1.1 General Description

BL-M8723DU1 is a highly integrated single-chip 802.11n Wireless LAN (WLAN) USB2.0 Multi-Function network interface controller with integrated Bluetooth 2.1/4.2 controller. It combines a WLAN MAC, a 1T1R capable WLAN baseband, and RF in a single chip. The RTL8723DU provides a complete solution for a high-performance integrated wireless and Bluetooth device. The integration provides better coordination between 802.11 and Bluetooth, and with sophisticated dynamic power control and packet traffic arbitration, RTL8723DU is able to provide the best coexistence performance Overview.

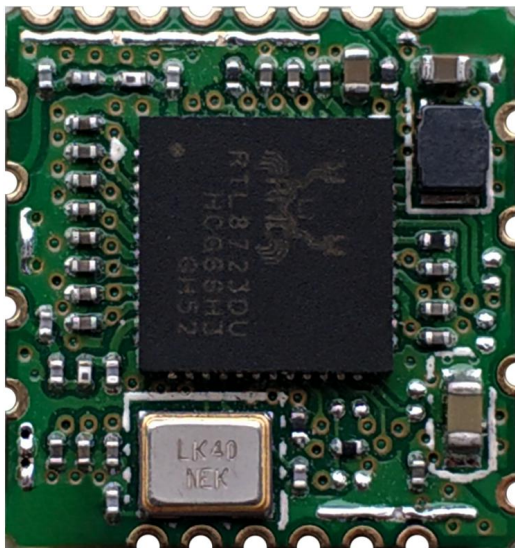

Figure 1 Top View



Figure 2 Bottom View

1.2 Features

- Operating Frequencies : 2.4~2.4835GHz
- Host Interface is USB, complies with USB 2.0
- IEEE Standards : IEEE 802.11b/g/n
- Wireless data rate can reach up to 150Mbps
- Bluetooth controller complies with Bluetooth core specification V4.2
- Connect to the external antenna through the half hole
- Power Supply:3.3V±0.2V

1.3 Applications

- MID
- IP Camera
- STB
- Smart TV
- E-book
- Other devices which need to be supported by wireless network

2. Functional Block Diagram

3.1. Single-Band 11n (1x1) Solution with Integrated Bluetooth Controller with Antenna Diversity

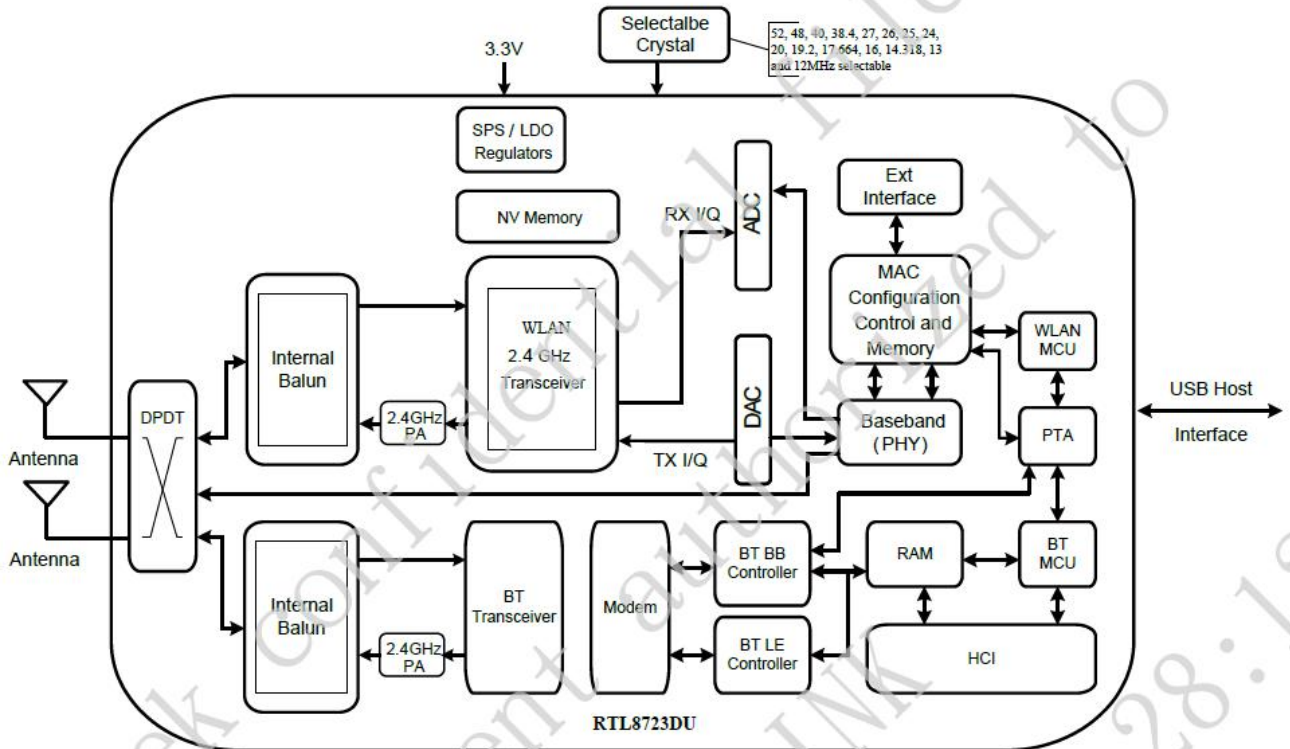

Figure 1. Single-Band 11n (1x1) and Integrated Bluetooth Controller Solution with Antenna Diversity

Figure 3 RTL8723DU block diagram

3. Product Technical Specifications

3.1 General Specifications

Item	Description
Product Name	BL-M8723DU1
Main Chip	RTL8723DU-CG
Host Interface	USB2.0
IEEE Standards	IEEE 802.11b/g/n B T: Compatible with Bluetooth v2.1,v4.2 Systems
Operating Frequencies	2.4GHz~2.4835GHz
Modulation	WiFi: 802.11b: CCK, DQPSK, DBPSK 802.11g: 64-QAM,16-QAM, QPSK, BPSK

	802.11n: 64-QAM,16-QAM, QPSK, BPSK BT: 8DPSK, $\pi/4$ DQPSK, GFSK
Working Mode	Infrastructure, Ad-Hoc
Wireless Data Rate	WIFI: 802.11b: 1, 2, 5.5, 11 802.11g: 6, 9, 12, 18, 24, 36, 48, 54 802.11n: MCS0~7, HT20 reach up to 72.2Mbps, HT40 reach up to 150Mbps BT: 1 Mbps for Basic Rate 2, 3 Mbps for Enhanced Data Rate
Rx Sensitivity	WIFI: -94dBm (Min) BT: -89dBm (Min)
TX Power	WIFI: 18dBm (Max) BT: 6.5dBm (Max)
Antenna Type	Connect to the external antenna through the half hole
Dimension(L*W*H)	(PCB) 12.2mm*12.9mm*0.8mm (L*W*H) , Tolerance: ± 0.15 mm
Power Supply	3.3V \pm 0.2V
Power Consumption	Standby 80mA@3.3V (Max) TX mode 330mA@3.3V (Max)
Clock Source	40MHz
Working Temperature	-20° C to +70° C
Storage Temperature	-40° C to +85° C

ESD CAUTION: Although this module is designed to be as robust as possible, Electrostatic Discharge (ESD) can damage this module. It must be protected from ESD at all times and handled under the protection of ESD.

3.2 DC Power Consumption

Vcc=3.3V, Ta = 25 °C, unit: mA				
Supply current	Typ.		Max	
Standby (RF disabled)	75		80	
802.11b	1Mbps		11Mbps	
Supply current	Typ.	Max.	Typ.	Max.
TX mode	320	330	285	300
Rx mode	89	90	90	92
802.11g	6Mbps		54Mbps	
Supply current	Typ.	Max.	Typ.	Max.
TX mode	260	270	190	205
Rx mode	89	90	92	95

802.11n HT20	MCS0		MCS7	
Supply current	Typ.	Max.	Typ.	Max.
TX mode	250	260	185	200
Rx mode	89	91	92	96
802.11n HT40	MCS0		MCS7	
Supply current	Typ.	Max.	Typ.	Max.
TX mode	240	250	180	190
Rx mode	90	92	95	99

3.3 RF Specifications

TX Power	802.11b: 17 ± 1.5 dBm 802.11g: 14 ± 1.5 dBm 802.11n-HT20/HT40: 14 ± 1.5 dBm BT: 10dBm (Max) -3 (Min)
TX Constellation Error(EVM)	802.11b: < -20 dB@11Mbps 802.11g: < -28 dB@54Mbps 802.11n-HT20: < -28 dB@72.2Mbps 802.11n-HT40: < -28 dB@150Mbps
Receiver Minimum Input Sensitivity@PER	1Mbps: -92dBm@PER<8%; 11Mbps: -85dBm@PER<8%; 54Mbps: -72dBm@PER<10%; 150Mbps: -66dBm@PER<10%; BT: -89dBm@1Mbps -85dBm@2Mbps -83dBm@3Mbps

RF performance parameter

Mode	Rate(Mbps)	Power(dBm)			EVM(dB)			Sensitivity(dBm)		
		CH1	CH7	CH13	CH1	CH7	CH13	CH1	CH7	CH13
11b	1	17.67	17.68	17.60	-33.46	-33.28	-33.03	-94	-94	-94
	11	17.62	17.74	17.73	-30.07	-28.72	28.66	-87	-87	-87
11g	6	14.48	14.58	14.45	-32.99	-30.85	-32.49	-90	-90	-90
	54	14.81	14.82	14.67	-33.21	-32.71	-32.76	-74	-74	-74
11n HT20	MCS0	14.77	14.88	14.29	-29.36	-28.26	-30.83	-90	-90	-90
	MCS7	14.98	14.74	14.68	-33.09	-31.11	-32.51	-70	-70	-70
Mode	Rate(Mbps)	Power(dBm)			EVM(dB)			Sensitivity(dBm)		
		CH3	CH7	CH11	CH3	CH7	CH11	CH3	CH7	CH11
11n HT40	MCS0	14.35	14.47	14.32	-32.09	-31.16	-31.00	-88	-88	-88
	MCS7	14.71	14.66	14.60	-32.53	-30.65	-31.45	-68	-68	-68
		Avg.Power(dBm)			DEVm Avg(%)			Omega-i(kHZ)		
channel(MHZ)		CH0	CH40	CH78	CH0	CH40	CH78	CH0	CH40	CH78
1M	1DH1	6.49	6.45	6.20	/	/	/	-4.16	-3.31	-4.97
2M	2DH3	5.67	5.46	5.11	4.43	4.82	4.75	-3.54	-4.23	-4.12

3M	3DH5	5.65	5.37	5.21	4.96	5.24	4.96	-3.49	-3.64	-3.44
----	------	------	------	------	------	------	------	-------	-------	-------

4. Pin Assignments

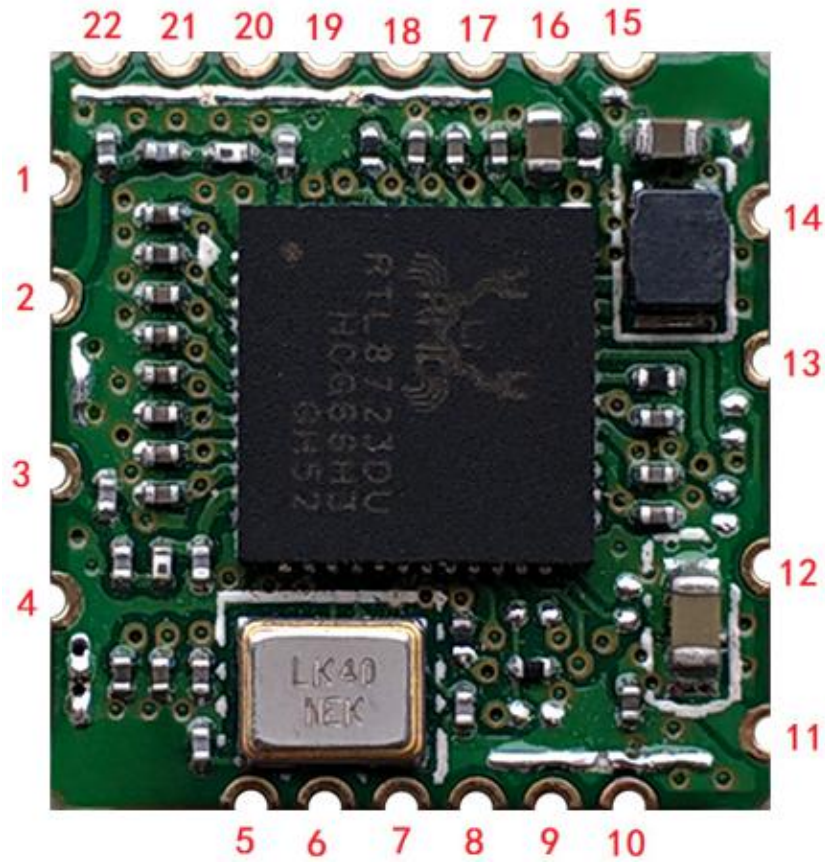

Figure 4 Pin Assignments (Top view)

Pin No.	Pin Name	Description
1	GND	Grond
2	RF-S0	WLAN/BT RF signal output
3	RF-S1	NC
4	GND	Grond
5	BT_PCM_IN	General Purpose Input/Output Pin
6	BT_PCM_OUT	General Purpose Input/Output Pin
7	BT_PCM_SYNC	General Purpose Input/Output Pin
8	BT_PCM_CLK	General Purpose Input/Output Pin
9	BT_WAKE_HST	Chip wakeup host
10	HST_WAKE_BT	host wakeup Chip
11	VDD33	The power input 3.3V

12	DM	High-Speed USB D- Signal
12	DP	High-Speed USB D+ Signal
14	GND	Grond
15	N	No attributes
16	WL_DIS#	This Pin Can Externally Shutdown the RTL8723DU WLAN function when WL_DISn is Pulled Low. When this pin deasserted,USB interface will be disabled. The WLAN Radio-off function with host interface remaining connected.
17	BT_DIS#	This Pin Can Externally Shutdown the RTL8723DU BT function when BT_DISn is Pulled Low. This pin can also support the BT Radio-off function with host interface remaining connected.
18	N	No attributes
19	HST_WAKE_WL	General Purpose Input/Output Pin
20	WL_WAKE_HST	General Purpose Input/Output Pin
21, 22	N	No attributes

5. Peripheral Schematic Reference Design

Circuit reference pictures were designed

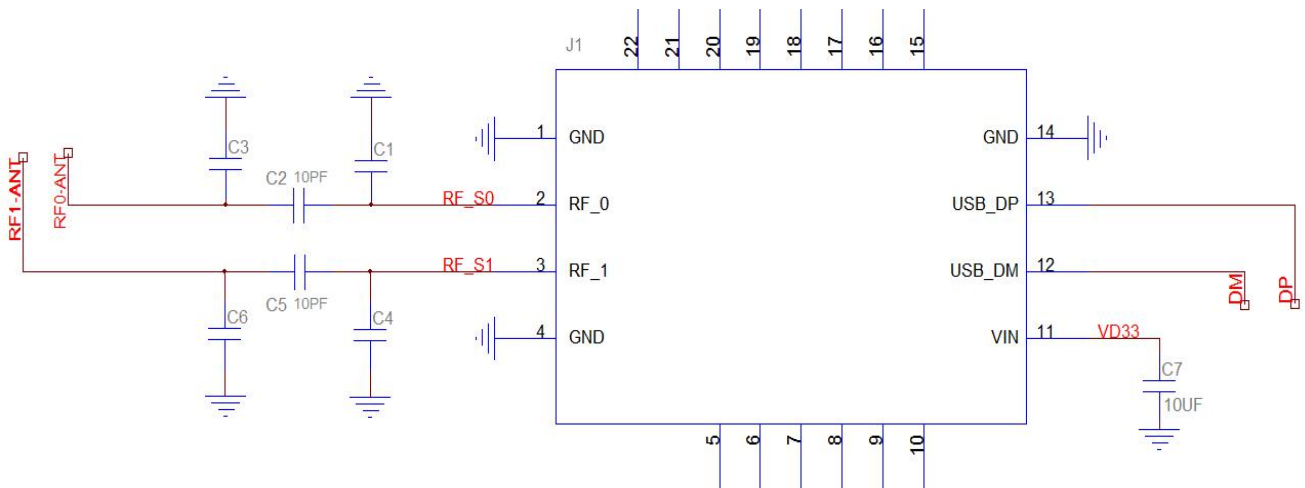

- Note:
1. Pls reserve a "pi" circuit for antenna matching.
 2. The RF circuit needs to keep 50 Ω impedance.
 3. The USB differential pair needs to keep 90 Ω impedance.
 4. reserved filter capacitance for 3.3 V power input

B

6. Mechanical Specifications

PCB Module dimension: Typical (L*W * H): 12.2mm*12.9mm*0.8mm Tolerance : +/-0.15mm

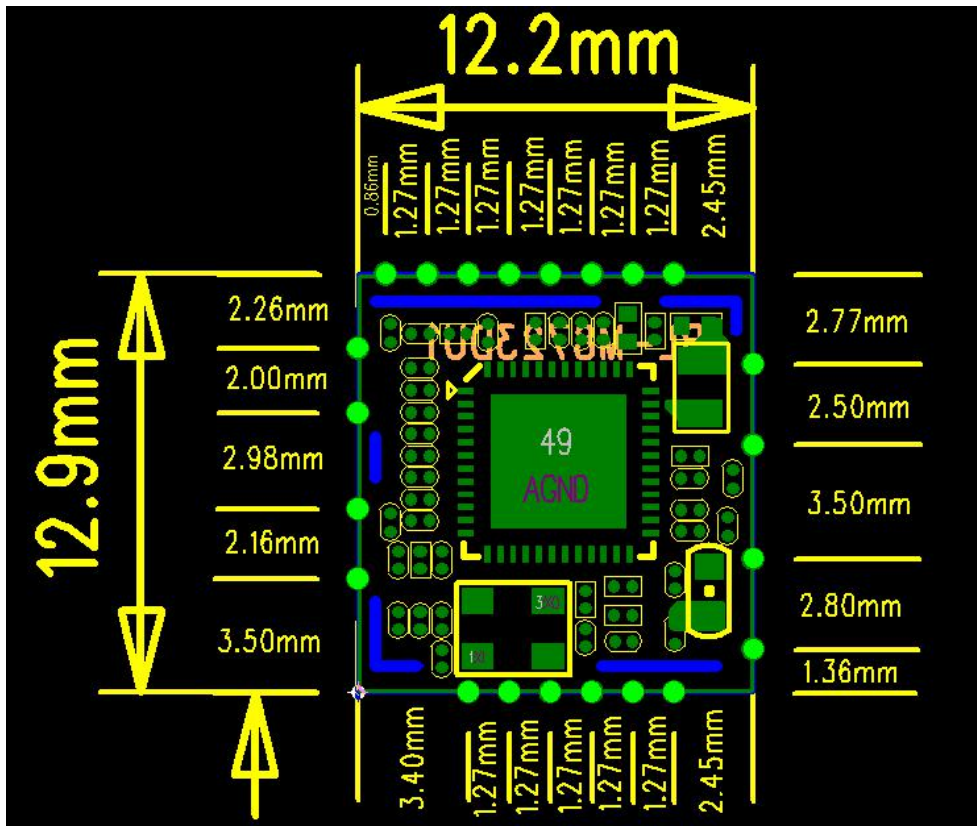

Figure 5

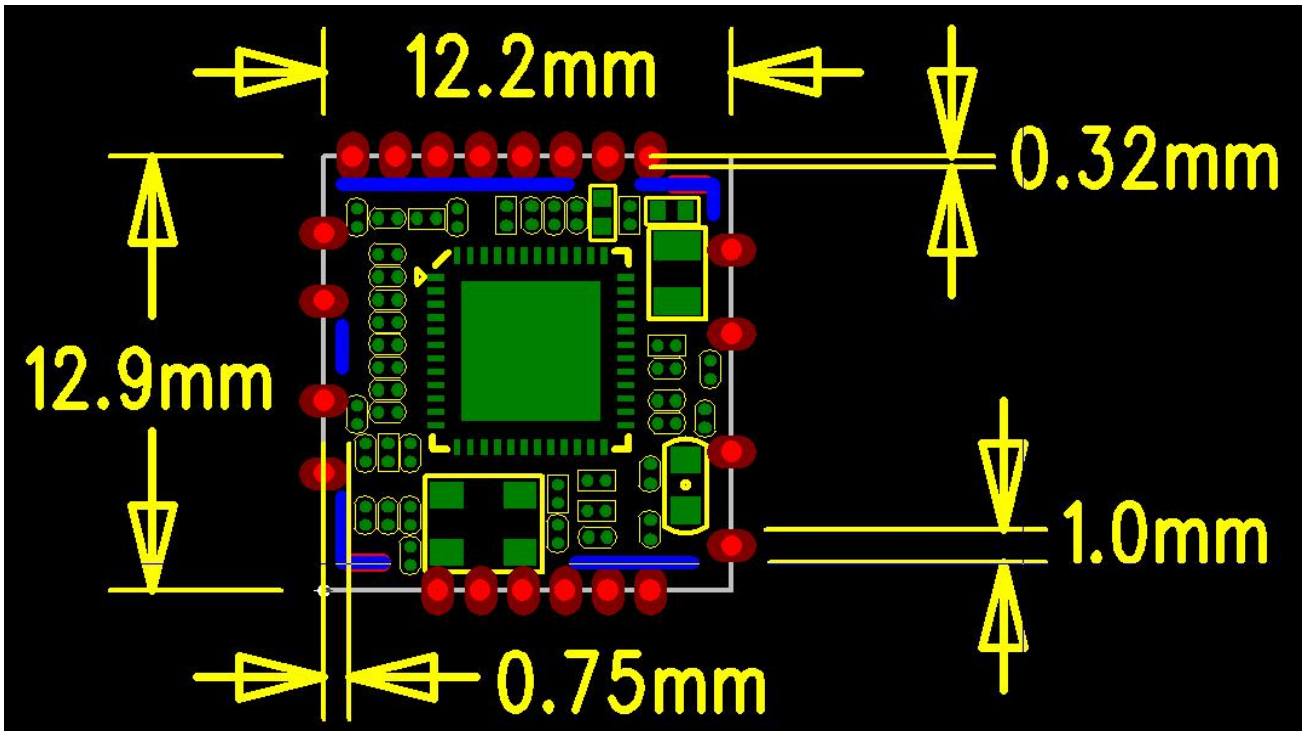

Figure 6

7. Others

7.1 Package Information

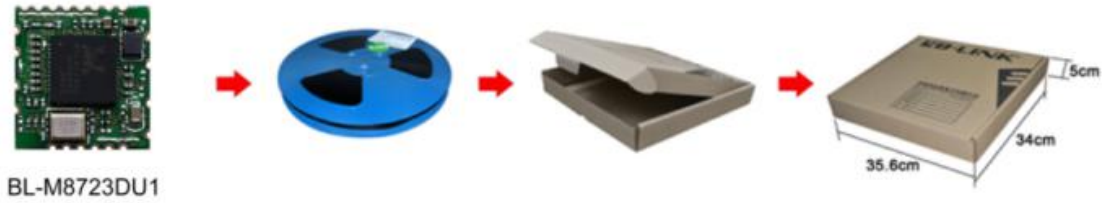

Figure 7 Package Information

7.2 Storage Temperature and Humidity

Storage Condition: Moisture barrier bag must be stored under 30°C, humidity under 85% RH.
 The calculated shelf life for the dry packed product shall be a 12 months from the bag seal date.
 Humidity indicator cards must be blue, <30%.

8. Typical Solder Reflow Profile

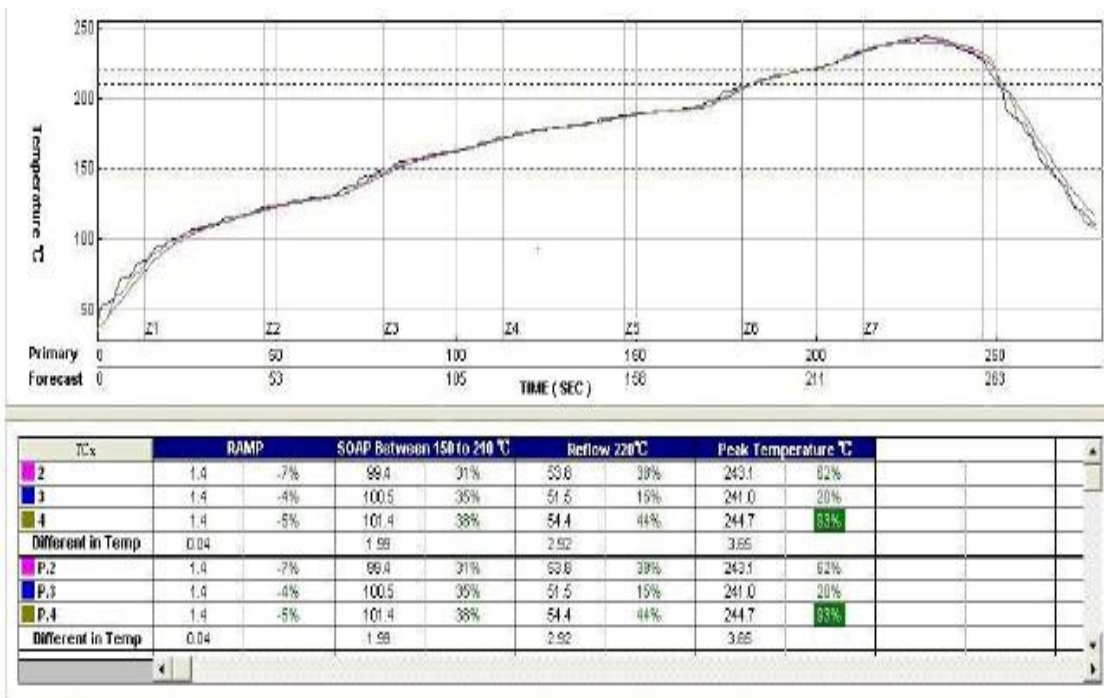

Figure 8