

IS32LT3146

40V/450mA, STANDALONE 6-CHANNEL LINEAR LED DRIVER WITH THERMAL SHUNT

June 2022

GENERAL DESCRIPTION

The IS32LT3146 device is a six-channel linear LED driver with a power resistor to shunt the power dissipation to optimize the thermal stress on the device. It supports both sequential turn on mode and traditional blink mode for turn signal light application. A logic level at the SEQEN pin is used to switch between these two modes. The startup delay time and channel to channel internal delay time of the sequential turn on are fully programmable by external resistors, and microcontroller is not required. The sequential turn on mode is able to implement multiple devices synchronization operation to realize more than 6 LED strings sequential turn on. A single resistor from the SEQMODE pin to GND selects sequential turn on styles: one channel by one channel, two channels by two channels, three channels by three channels or all channels simultaneous on.

For added system reliability, the IS32LT3146 integrates fault detection circuitry for LED open/short circuit, single LED short circuit, thermal roll-off and thermal shutdown conditions. The FAULTB pin is dedicated for fault conditions reporting.

The IS32LT3146 device is available in the eTSSOP-20 package with exposed pad for enhanced thermal dissipation.

APPLICATIONS

- Sequential turn light
- Welcome light
- Rear light

FEATURES

- Wide input voltage range: 5V~40V
- Thermal shunt resistor to optimize the device thermal stress
- Programmable sequential turn on of each channel
 - $\pm 5\%$ timer accuracy
 - Timing programmable by external resistors
 - Stand-alone sequential turn on timing for multiple devices operation (no signal wire connection among the devices)
 - Synchronized sequential turn on timing for multiple devices operation
 - Sequential turn on style selectable: one by one, two by two, three by three or all simultaneous on
 - Single pin to select between sequential turn on mode or traditional blink mode
- 6-CH current source driver
- Parallel outputs for higher current using multiple channels of a single IC or multiple ICs
- Adjustable constant output current set by a single resistor
 - Max. current: 75mA per channel
 - Max. current: 450mA in parallel operation
- Low headroom voltage
 - Max headroom: 500mV at 25mA per channel
 - Max headroom: 900mV at 75mA per channel
- Robust fault protection with reporting:
 - Fault modes selectable: “one fail all fail” or “one fail other on”
 - Single LED shorted - single resistor to set the detection threshold
 - LED string open/ short
 - Current setting pin (ISET) open/short
 - Thermal shutdown
 - External UVLO setting for single LED short and - LED string open detection
 - FAULTB pin for failure reporting, allowing parallel bus connection
- Current slew rate control to optimize EMI performance
- Thermal roll-off – over junction temperature current derating
- Operating junction temperature range -40°C to 150°C
- AEC-Q100 Qualified

IS32LT3146

TYPICAL APPLICATION CIRCUIT

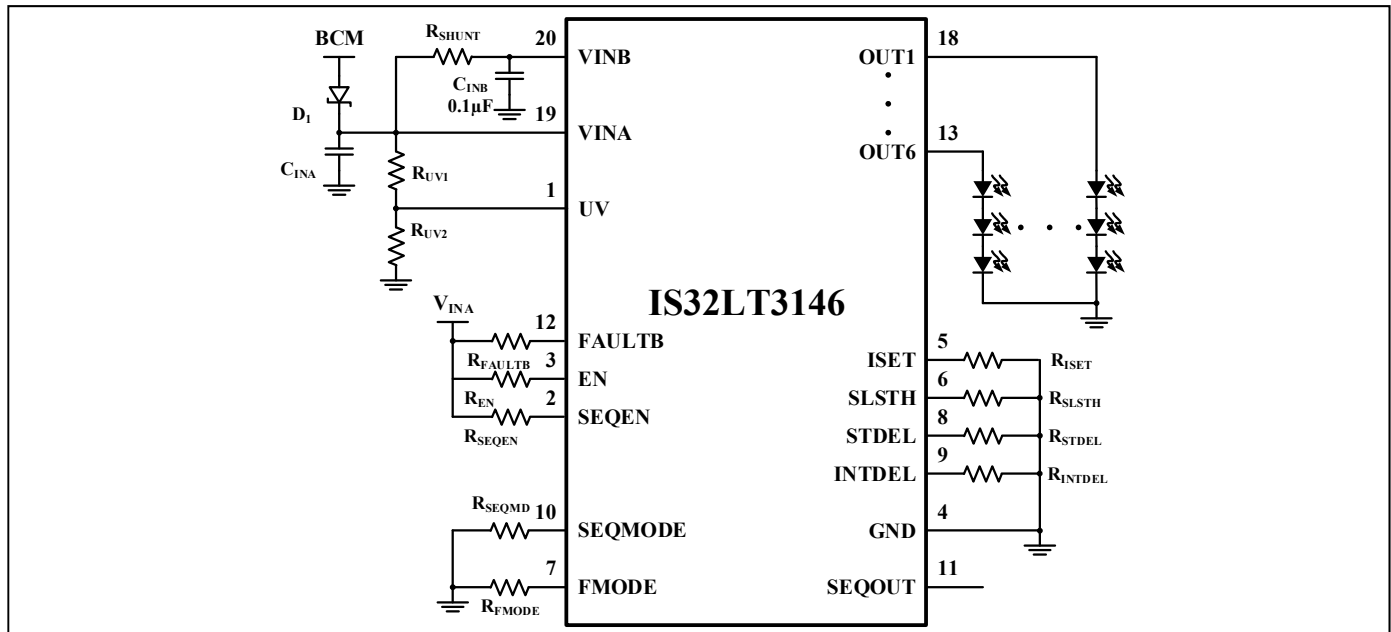

Figure 1 Typical Application Circuit

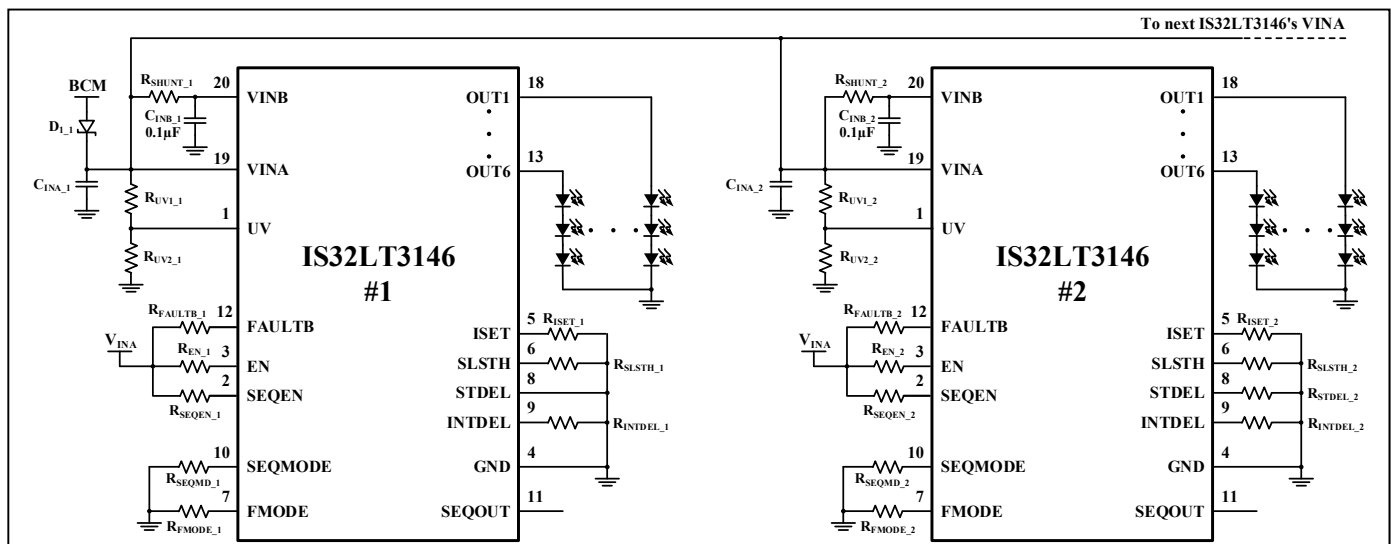

Figure 2 Typical Application Circuit of Stand-alone Sequential Turn On

(No signal connection wire is needed for multiple devices. This is useful for applications where devices are far away from each other)

IS32LT3146

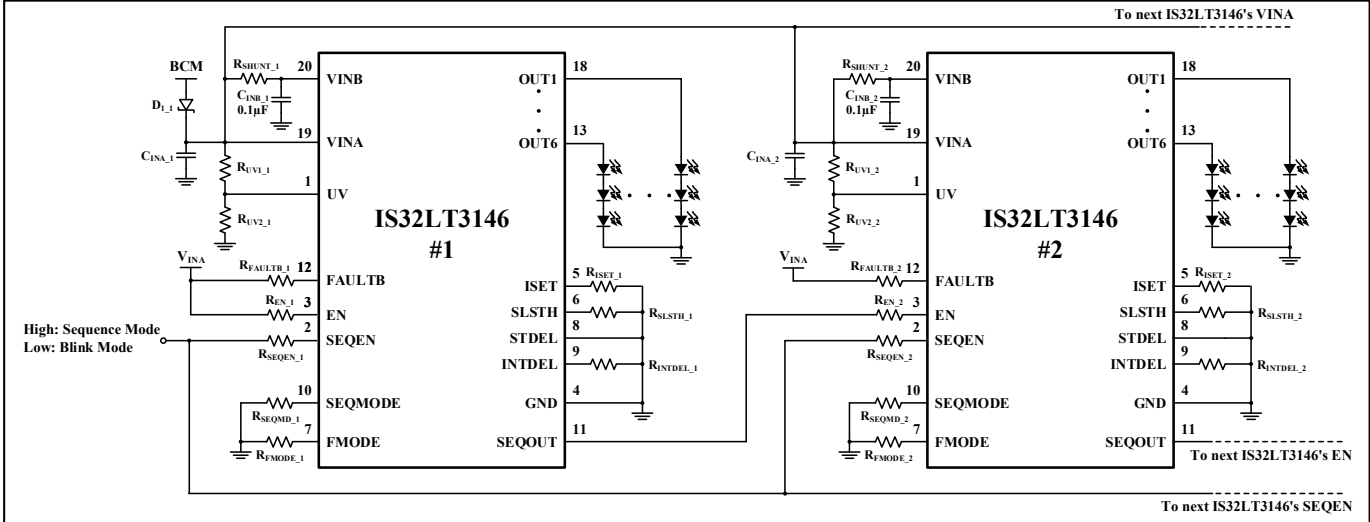
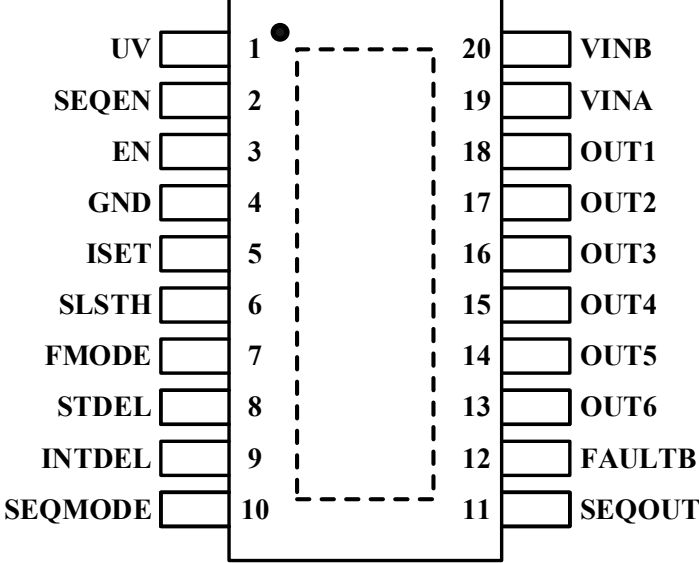

Figure 3 Typical Application Circuit of Synchronized Sequential Turn On

Note 1: The recommended value of R_{EN} and R_{SEQEN} is 10kΩ.

IS32LT3146

PIN CONFIGURATION

Package	Pin Configuration (Top View)
eTSSOP-20	 <p>The diagram shows a top view of the eTSSOP-20 package with 20 pins. Pin 1 is marked with a solid dot. A dashed line indicates the internal chip layout. The pin functions are as follows:</p> <ul style="list-style-type: none"> Pin 1: UV Pin 2: SEQEN Pin 3: EN Pin 4: GND Pin 5: ISET Pin 6: SLSTH Pin 7: FMODE Pin 8: STDEL Pin 9: INTDEL Pin 10: SEQMODE Pin 11: SEQOUT Pin 12: FAULTB Pin 13: OUT6 Pin 14: OUT5 Pin 15: OUT4 Pin 16: OUT3 Pin 17: OUT2 Pin 18: OUT1 Pin 19: VINA Pin 20: VINB

PIN DESCRIPTION

No.	Pin	Description
1	UV	With an external resistor divider, it can set external UVLO for LED string open and single LED short fault detection.
2	SEQEN	Active-high input. "1" to enable sequential turn on mode. Note: If tied to ground, all channels will turn on simultaneously as EN pin is pulled high; enabling traditional blink mode.
3	EN	Device enable pin. It also is used as the sequential turn on synchronization signal input pin.
4	GND	Ground pin.
5	ISET	Resistor on this pin to GND sets the maximum output current for channel OUT1~OUT6.
6	SLSTH	Single LED short detection voltage setting pin. Connect a resistor to ground to set.
7	FMODE	Fault action mode select pin. Connect a proper value resistor to ground to select.
8	STDEL	Resistor from this pin to GND sets the startup delay time of the sequential on.
9	INTDEL	Resistor from this pin to GND sets the interval delay time of the sequential on.
10	SEQMODE	Sequential turn on style select pin. Connect a proper value resistor to ground to select: one by one, two by two, three by three or all simultaneous on.
11	SEQOUT	Sequential turn on synchronization signal output pin.
12	FAULTB	Open drain I/O diagnostic pin. Active-low output driven by the device when it detects a fault condition. As an input ($R_{FMODE}=0\Omega$ or $27k\Omega$), this pin will accept an externally generated FAULTB signal to disable the device output to satisfy the "One-Fail-All-Fail" function. Note: this pin requires an external pull up resistor (R_{FAULTB}).
13~18	OUT6~OUT1	Current output pin. Connect the anode of the LED string to this pin and cathode to GND.
19	VINA	Power supply pin.
20	VINB	Thermal shunt pin. Connect a power resistor from VINA to this pin to shunt the power dissipation on the device.
	Thermal Pad	Must be connected to GND with sufficient copper for heat sink.

IS32LT3146

ORDERING INFORMATION

Automotive Range: -40°C to +125°C

Order Part No.	Package	QTY/Reel
IS32LT3146-ZLA3-TR	eTSSOP-20, Lead-free	2500

Copyright © 2022 Lumissil Microsystems. All rights reserved. Lumissil Microsystems reserves the right to make changes to this specification and its products at any time without notice. Lumissil Microsystems assumes no liability arising out of the application or use of any information, products or services described herein. Customers are advised to obtain the latest version of this device specification before relying on any published information and before placing orders for products.

Lumissil Microsystems does not recommend the use of any of its products in life support applications where the failure or malfunction of the product can reasonably be expected to cause failure of the life support system or to significantly affect its safety or effectiveness. Products are not authorized for use in such applications unless Lumissil Microsystems receives written assurance to its satisfaction, that:

- a.) the risk of injury or damage has been minimized;
- b.) the user assume all such risks; and
- c.) potential liability of Lumissil Microsystems is adequately protected under the circumstances

IS32LT3146

ABSOLUTE MAXIMUM RATINGS (NOTE 2)

Voltage at VINA, VINB pins	-0.3V ~ +45V
Voltage at UV, SEQEN, EN, STDEL, INTDEL, SEQMODE, SEQOUT, FAULTB, OUT1~OUT6 pins	-0.3V ~ V _{INA} +0.3V
Voltage at ISET, SLSTH, FMODE pins	-0.3V ~ +7V
Operating temperature, T _A =T _J	-40°C ~ +150°C
Storage temperature, T _{STG}	-65°C ~ +150°C
Junction temperature, T _{JMAX}	+150°C
Package thermal resistance, junction to ambient (4-layer standard test PCB based on JESD 51-2A), θ _{JA}	31.8°C/W
Package thermal resistance, junction to thermal PAD (4-layer standard test PCB based on JESD 51-8), θ _{JP}	14.46°C/W
ESD (HBM)	±2kV
ESD (CDM)	±750V

Note 2: Stresses beyond those listed under “Absolute Maximum Ratings” may cause permanent damage to the device. These are stress ratings only and functional operation of the device at these or any other condition beyond those indicated in the operational sections of the specifications is not implied. Exposure to absolute maximum rating conditions for extended periods may affect device reliability.

ELECTRICAL CHARACTERISTICS

Valid at V_{INA}= 12V, unless noted otherwise. Refer to each condition description.

“●” symbol indicates specifications across the full operating temperature range with T_A= T_J= -40°C to +150°C, other specifications are at T_A= T_J= 25°C; unless noted otherwise. (Note 4)

Symbol	Parameter	Conditions	Min.	Typ.	Max.	Unit	
Input Supply							
V _{INA}	Operating input voltage range		●	5.0	40	V	
V _{INA_UV}	V _{INA} undervoltage release	Voltage rising	●	4.7	4.9	V	
V _{INA_UVHY}	V _{INA} undervoltage-lockout hysteresis	IC disabled		280		mV	
I _{IN}	Quiescent current (I _{VINA} +I _{VINB})	V _{INA} =V _{INB} , EN=High, R _{ISET} =6.2kΩ	●	5	7	9	mA
I _{SD}	Shutdown current (I _{VINA} +I _{VINB})	EN=Low	●	30	55	80	μA
I _{FAULT}	Shutdown current in fault mode (I _{VINA} +I _{VINB})	V _{INA} =V _{INB} , R _{FMODE} =0Ω, one fail all fail mode, FAULTB=Low	●	1.4	2.2	3	mA
t _{ON}	Startup time from VIN rising edge to current rising edge after first power-up	EN=High, SEQMODE=Low		110	200	μs	
Current Regulation							
I _{OUT_R}	Output current range per channel			-75	-10	mA	
V _{ISET}	ISET pin reference voltage		●	1.15		V	
I _{OUT}	Output current per channel	R _{ISET} =6.2kΩ, V _{INA} =V _{INB} , (V _{INA} -V _{OUT})=1.5V	●	-81	-75	-69	mA
		R _{ISET} =18.6kΩ, V _{INA} =V _{INB} , (V _{INA} -V _{OUT})=1.5V	●	-28	-25	-22	
E _{OUT_M}	OUT1~OUT6 current matching in one device	R _{ISET} =6.2kΩ	●	-6	6	%	
		R _{ISET} =18.6kΩ	●	-12	12		
V _{HR_MIN}	Minimum headroom voltage from VINA to OUTx (VINB pin tied to VINA pin)	Measured at (V _{INA} -V _{OUTx})	R _{ISET} =6.2kΩ	●		900	mV
			R _{ISET} =18.6kΩ	●		500	

IS32LT3146

ELECTRICAL CHARACTERISTICS (CONTINUE)

Valid at $V_{INA} = 12V$, unless noted otherwise. Refer to each condition description.

“•” symbol indicates specifications across the full operating temperature range with $T_A = T_J = -40^{\circ}C$ to $+150^{\circ}C$, other specifications are at $T_A = T_J = 25^{\circ}C$; unless noted otherwise. (Note 4)

Symbol	Parameter	Conditions	Min.	Typ.	Max.	Unit	
t_{SL}	Current rising/falling slew time (rising from 10% to 90% levels and falling from 90% to 10% levels)	$R_{ISET} = 6.2k\Omega$	•	6	16	38	μs
		$R_{ISET} = 18.6k\Omega$	•	3	13	23	
I_{OUT_L}	Output current limit per channel	ISET shorted to GND	•	-150	-112	-85	mA
V_{ABTR}	The voltage threshold of current full transition from V_{INA} to V_{INB}	$R_{ISET} = 6.2k\Omega$, measured at ($V_{INB} - V_{OUT_MAX}$)			1.1		V
t_{ABTR}	The period time of 85% current transition from V_{INA} to V_{INB}	$R_{ISET} = 6.2k\Omega$			600		μs

Timing Control

I_{STDEL}	STDEL pin output current		•		30		μA
I_{INTDEL}	INTDEL pin output current		•		30		μA
t_{STDEL_R}	Programmable timing range of startup delay		•	50		500	ms
t_{INTDEL_R}	Programmable timing range of interval delay		•	10		100	ms
E_{STDEL}	Startup delay time accuracy	$T_A = T_J = 25^{\circ}C$		-3		3	%
		$T_A = T_J = -40^{\circ}C$ to $+150^{\circ}C$	•	-5		5	%
E_{INTDEL}	Interval delay time accuracy	$T_A = T_J = 25^{\circ}C$		-3		3	%
		$T_A = T_J = -40^{\circ}C$ to $+150^{\circ}C$	•	-5		5	%
t_{STDEL}	Sequence startup delay time	$R_{STDEL} = 9.1k\Omega$	•	47.5	50	52.5	ms
		$R_{STDEL} = 75k\Omega$	•	475	500	525	
t_{INTDEL}	Sequence interval delay time	$R_{INTDEL} = 9.1k\Omega$	•	9.5	10	10.5	ms
		$R_{INTDEL} = 75k\Omega$	•	95	100	105	
$t_{STDELMIN}$	Minimum Startup delay time (from EN rising edge to 10% output current of OUT1)	Sequential turn on mode, SEQEN=High, $V_{STDEL} = GND$	•	70	110	150	μs
I_{SEQMD}	SEQMODE pin output current		•		30		μA
R_{SEQMD1}	SEQMODE pin resistance range for sequential turn on style 1: one by one		•		0	100	Ω
R_{SEQMD2}	SEQMODE pin resistance range for sequential turn on style 2: two by two		•	24	27	30	k Ω
R_{SEQMD3}	SEQMODE pin resistance range for sequential turn on style 3: three by three		•	58	62	66	k Ω
R_{SEQMD4}	SEQMODE pin resistance range for sequential turn on style 4: all simultaneous on		•	140	150	160	k Ω

IS32LT3146

ELECTRICAL CHARACTERISTICS (CONTINUE)

Valid at $V_{INA} = 12V$, unless noted otherwise. Refer to each condition description.

“•” symbol indicates specifications across the full operating temperature range with $T_A = T_J = -40^\circ C$ to $+150^\circ C$, other specifications are at $T_A = T_J = 25^\circ C$; unless noted otherwise. (Note 4)

Symbol	Parameter	Conditions	Min.	Typ.	Max.	Unit	
Logic Input and Output							
V_{IL}	EN, SEQEN and FAULTB pins input low voltage	Below V_{IL} level, input voltage considered as logic LOW	•		0.7	V	
V_{IH}	EN, SEQEN and FAULTB pins input high voltage	Above V_{IH} level, input voltage considered as logic HIGH	•	2.3		V	
$V_{OL_FLT B}$	FAULTB pin output low voltage	$I_{SINK} = 1mA$	•	0.1	0.4	V	
V_{OL_SOUT}	SEQOUT pin output low voltage	$I_{SINK} = 50\mu A$	•	0.2	0.4	V	
V_{OH}	SEQOUT pins output high voltage	$I_{SOURCE} = -50\mu A$	•	3	3.6	5	V
I_{PD}	EN and SEQEN pins internal pull-down current	Pin connected to 12V	•	4	7	15	μA
V_{UVTH}	UV pin threshold voltage	Voltage rising	•	1.12	1.2	1.28	V
V_{UVTH_HY}	UV pin threshold voltage hysteresis		•		30		mV
Protection							
I_{FMODE}	FMODE pin output current				30	μA	
R_{FMODE1}	FMODE pin resistance range for fault action mode 1		•		0	100	Ω
R_{FMODE2}	FMODE pin resistance range for fault action mode 2		•	24	27	30	k Ω
R_{FMODE3}	FMODE pin resistance range for fault action mode 3		•	58	62	66	k Ω
R_{FMODE4}	FMODE pin resistance range for fault action mode 4		•	140	150	160	k Ω
R_{ISET_OC}	Maximum R_{ISET} of ISET pin open circuit detection	Monitor FAULTB pin low	•	300			k Ω
R_{ISET_SC}	Minimum R_{ISET} of ISET pin short circuit detection	Monitor FAULTB pin low	•			1	k Ω
t_{FBDT}	ISET pin open/short detection deglitch time		•		50		μs
V_{SCV}	LED string short detection voltage	Voltage falling, measured at OUT_x to GND	•	0.8	1	1.2	V
V_{SCV_HY}	LED string short detection voltage hysteresis	Measured at OUT_x to GND	•		210		mV
I_{RTR}	Fault retry current		•		4		mA
V_{OCV}	LED string open fault detection voltage	$V_{UV} > V_{UVTH}$, measured at $(V_{INB} - V_{OUT_x})$, voltage falling	•	29	40	49	mV
V_{OCV_HY}	LED string open fault detection voltage hysteresis	$V_{UV} > V_{UVTH}$, measured at $(V_{INB} - V_{OUT_x})$, voltage rising	•		20		mV

IS32LT3146

ELECTRICAL CHARACTERISTICS (CONTINUE)

Valid at $V_{INA} = 12V$, unless noted otherwise. Refer to each condition description.

“•” symbol indicates specifications across the full operating temperature range with $T_A = T_J = -40^{\circ}C$ to $+150^{\circ}C$, other specifications are at $T_A = T_J = 25^{\circ}C$; unless noted otherwise. (Note 4)

Symbol	Parameter	Conditions	Min.	Typ.	Max.	Unit
I_{SLSTH}	SLSTH pin output current		• 30	32	34	μA
V_{SLSTH_RG}	Maximum voltage threshold of single LED short detection	(Note 3)			8.5	V
V_{SLSTH}	Single LED short detection voltage threshold	Voltage falling, $R_{SLSTH} = 30k\Omega$	• 2.64	2.88	3.09	V
		Voltage falling, $R_{SLSTH} = 51k\Omega$	• 4.546	4.896	5.2	
V_{SLSTH_HY}	Single LED short detection voltage threshold hysteresis		•	100		mV
t_{FBDEL}	LED string open/short and single LED short fault reporting delay time		•	2		ms
T_{RO}	Thermal roll-off activation temperature	(Note 3)		150		$^{\circ}C$
T_{SD}	Over temperature shutdown	Temperature increasing (Note 3)		175		$^{\circ}C$
T_{SDHY}	Over temperature hysteresis	Recovery = $T_{SD} - T_{SDHY}$ (Note 3)		20		$^{\circ}C$

Note 3: Guaranteed by design.

Note 4: Limits are 100% production tested at $-40^{\circ}C$, $25^{\circ}C$ and $125^{\circ}C$. Limits over the full operating temperature range verified through either bench and/or tester testing and correlation using Statistical methods.

IS32LT3146

TYPICAL PERFORMANCE CHARACTERISTICS

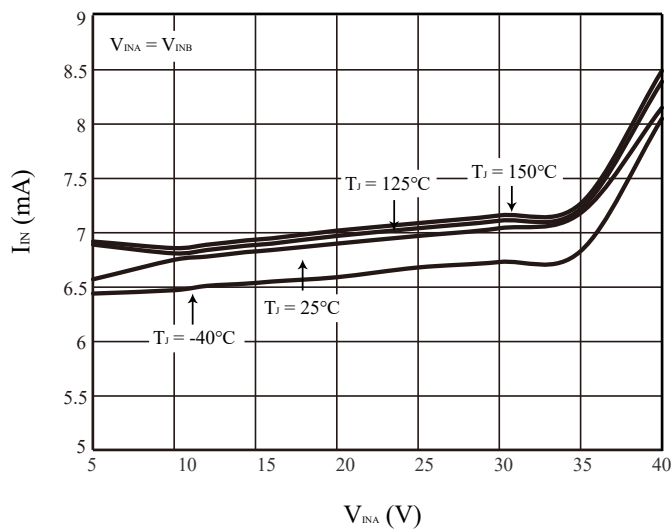

Figure 4 I_{IN} VS. V_{INA}

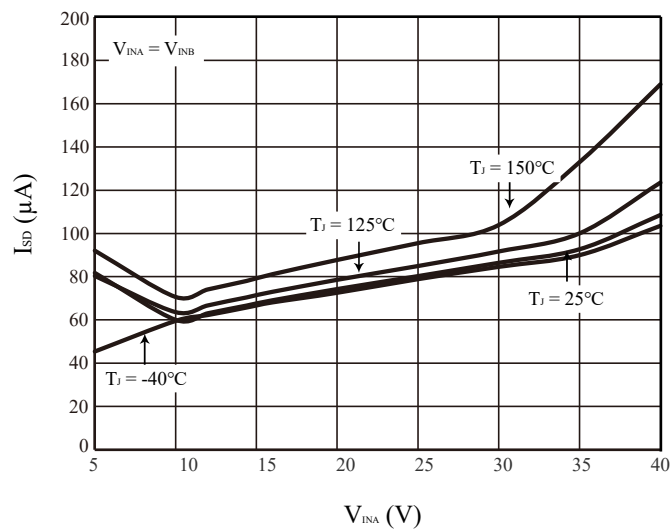

Figure 5 I_{SD} VS. V_{INA}

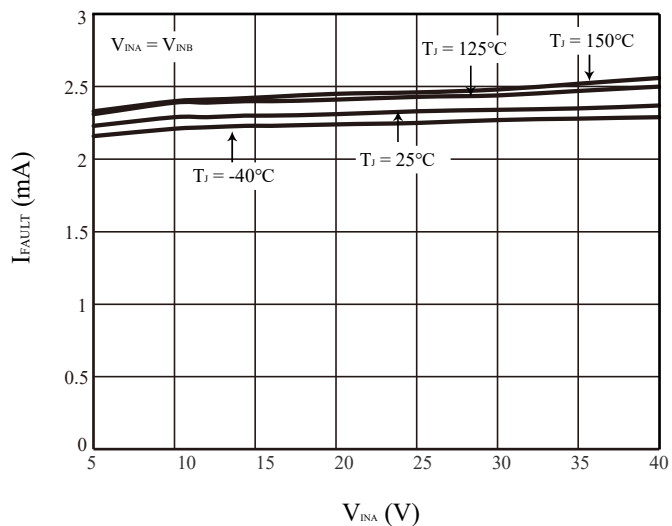

Figure 6 I_{FAULT} VS. V_{INA}

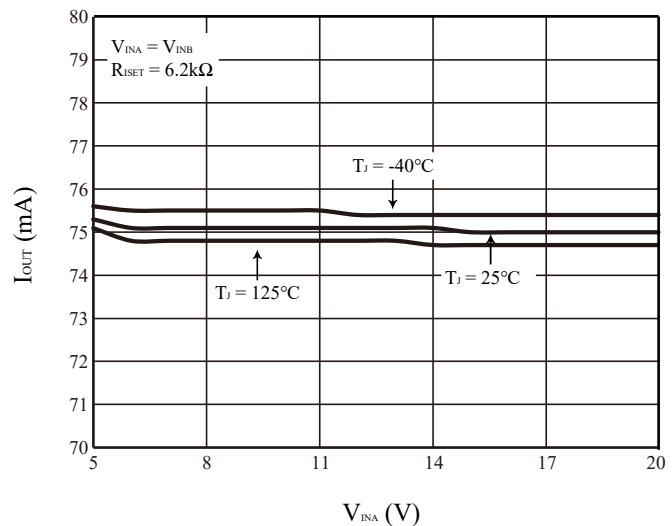

Figure 7 I_{OUT} VS. V_{INA}

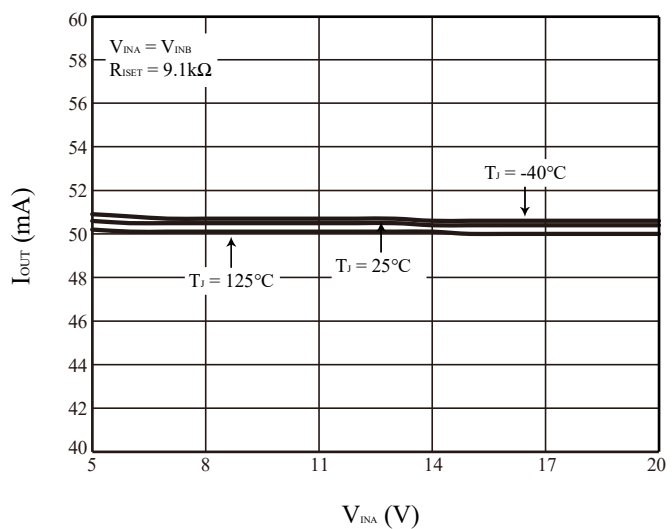

Figure 8 I_{OUT} VS. V_{INA}

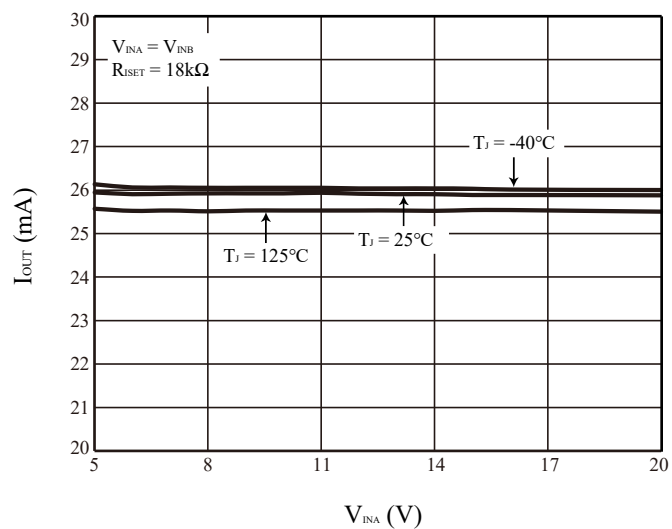

Figure 9 I_{OUT} VS. V_{INA}

IS32LT3146

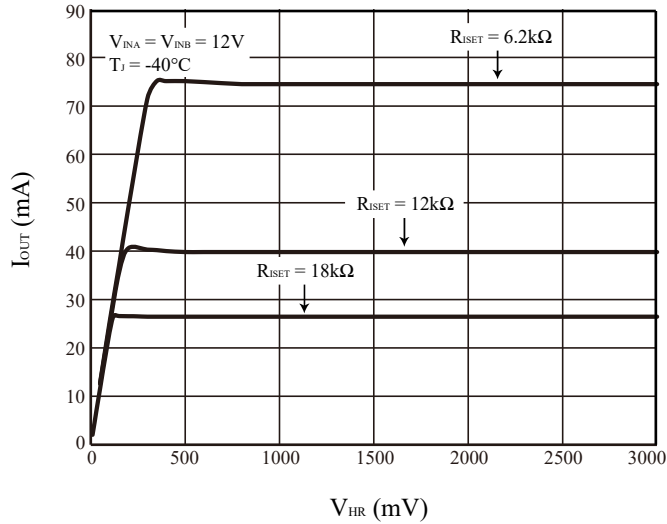

Figure 10 I_{OUT} vs. V_{HR}

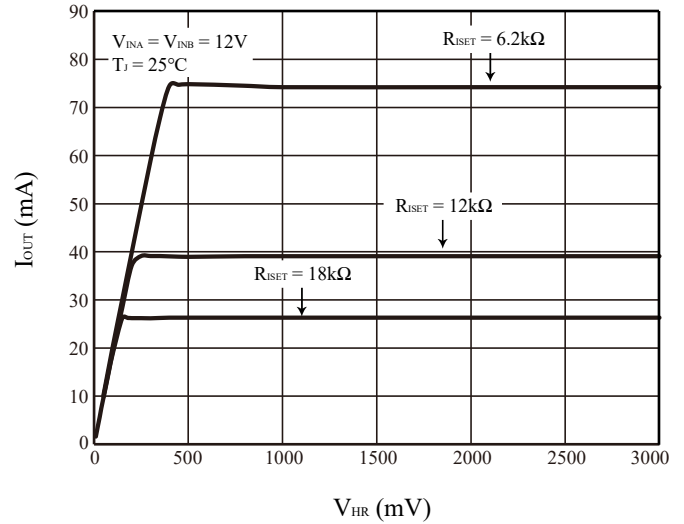

Figure 11 I_{OUT} vs. V_{HR}

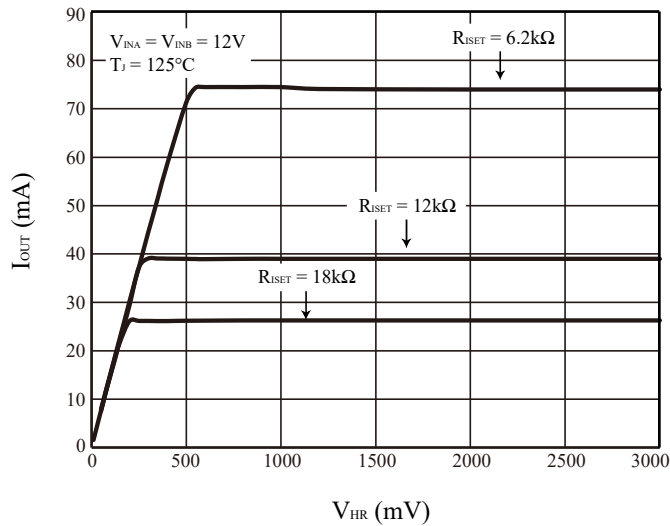

Figure 12 I_{OUT} vs. V_{HR}

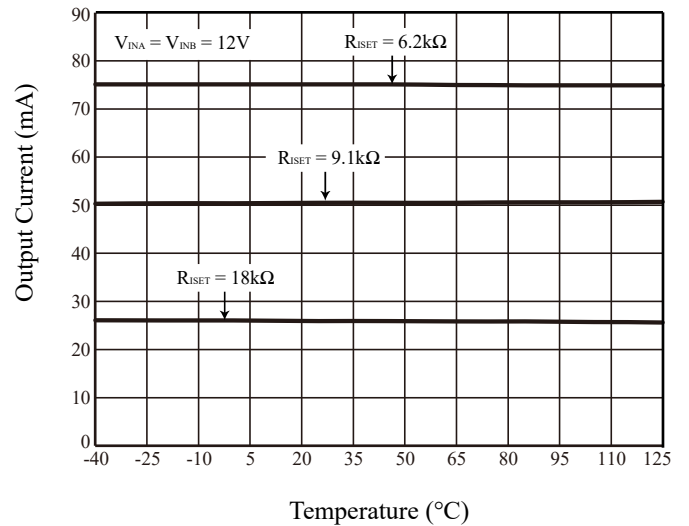

Figure 13 I_{OUT} vs. Temperature

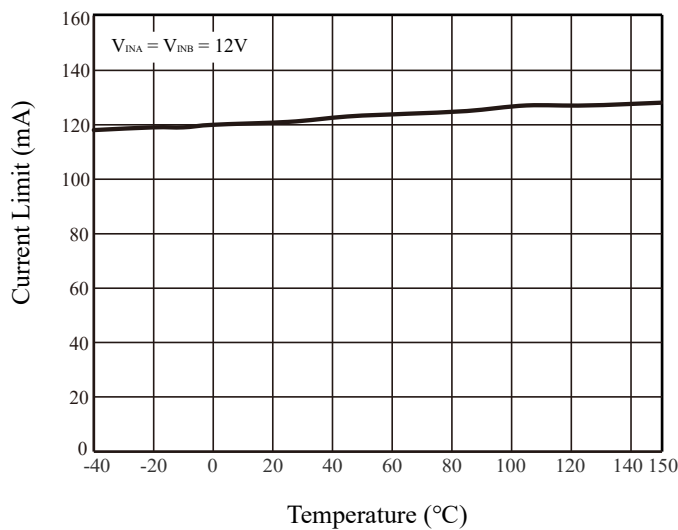

Figure 14 I_{OUT_L} vs. Temperature

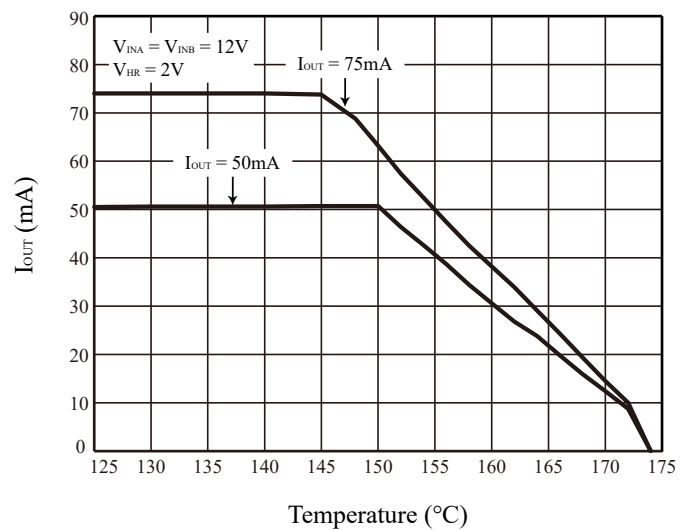

Figure 15 I_{OUT} vs. Temperature (Thermal Roll-Off)

IS32LT3146

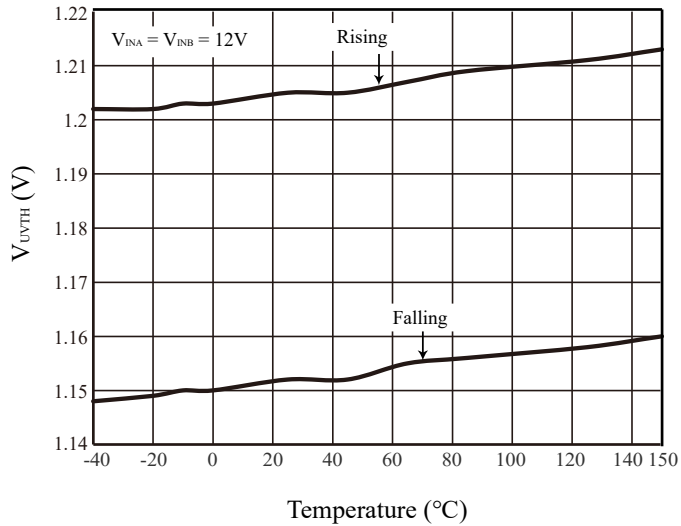

Figure 16 V_{UVTH} vs. Temperature

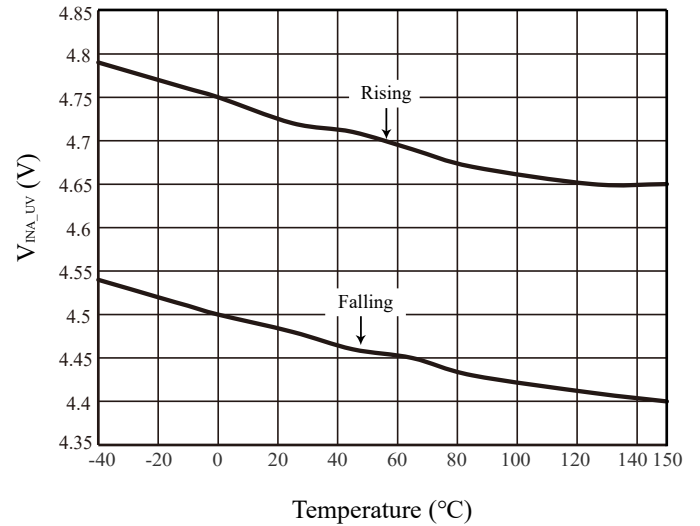

Figure 17 V_{INA_UV} vs. Temperature

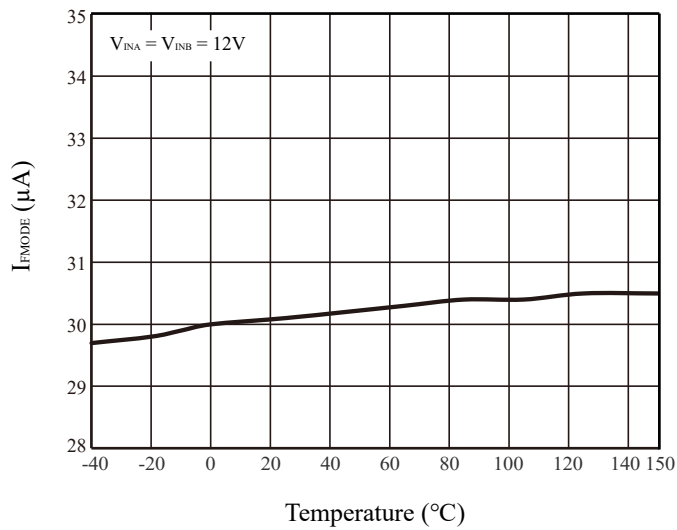

Figure 18 I_{FMODE} vs. Temperature

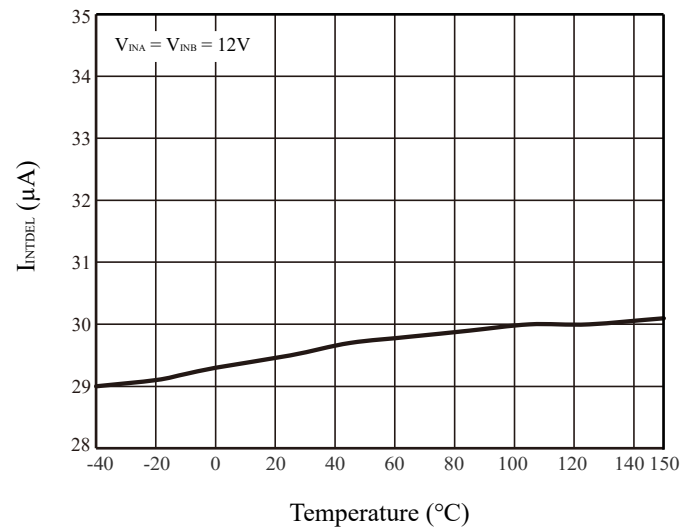

Figure 19 I_{INTDEL} vs. Temperature

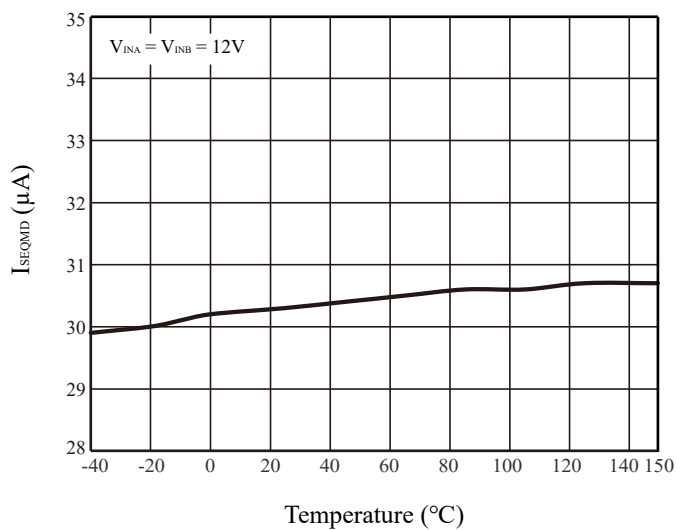

Figure 20 I_{SEQMD} vs. Temperature

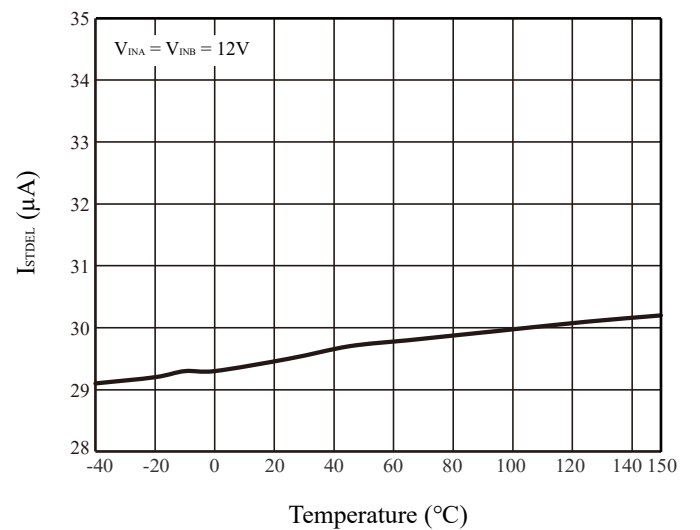

Figure 21 I_{STDEL} vs. Temperature

IS32LT3146

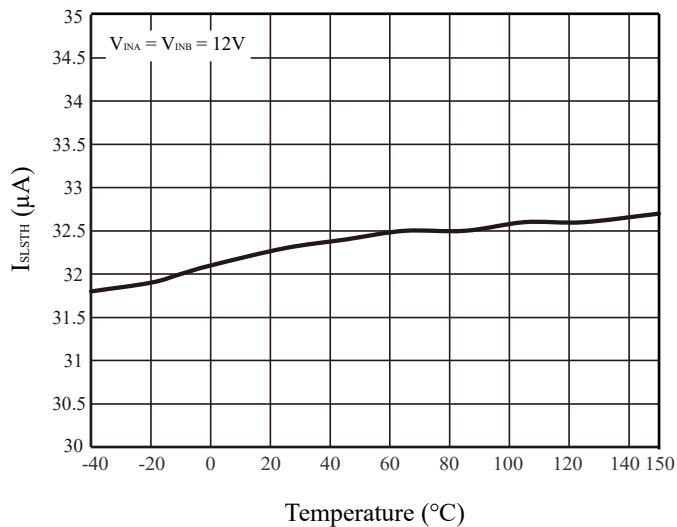

Figure 22 I_{SLSLTH} vs. Temperature

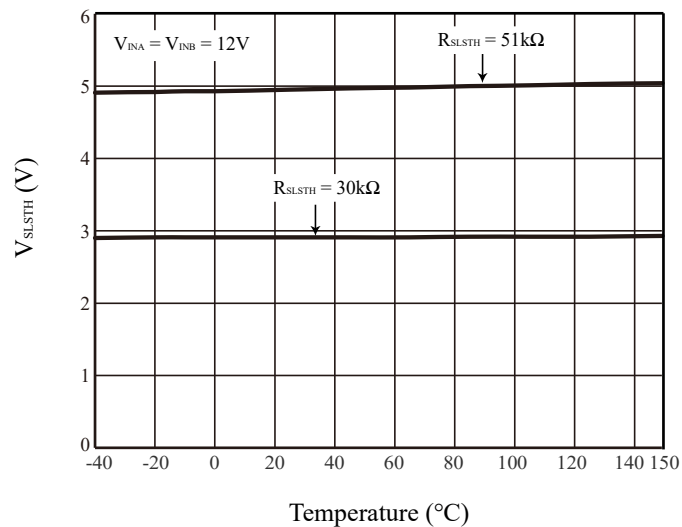

Figure 23 V_{SLSLTH} vs. Temperature

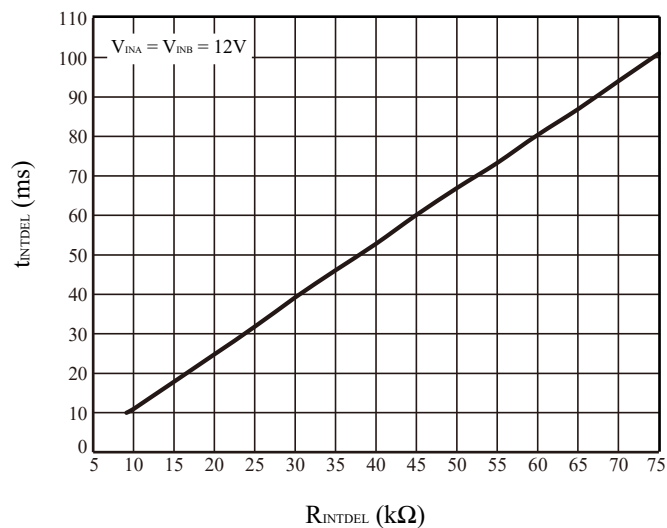

Figure 24 t_{INTDEL} vs. R_{INTDEL}

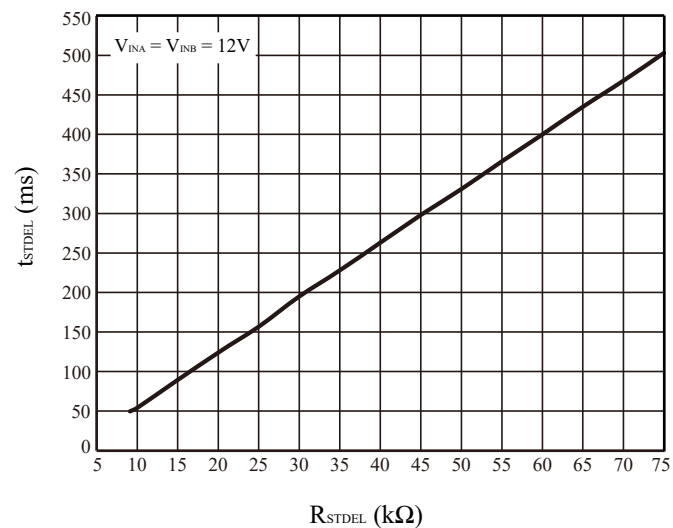

Figure 25 t_{STDEL} vs. R_{STDEL}

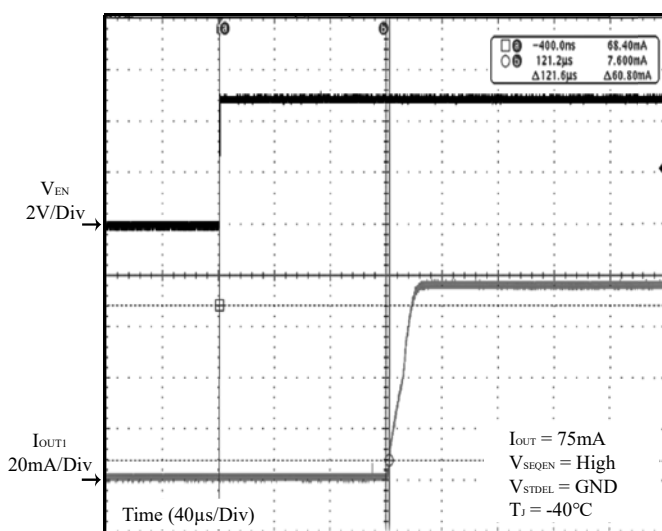

Figure 26 $t_{STDELMIN}$

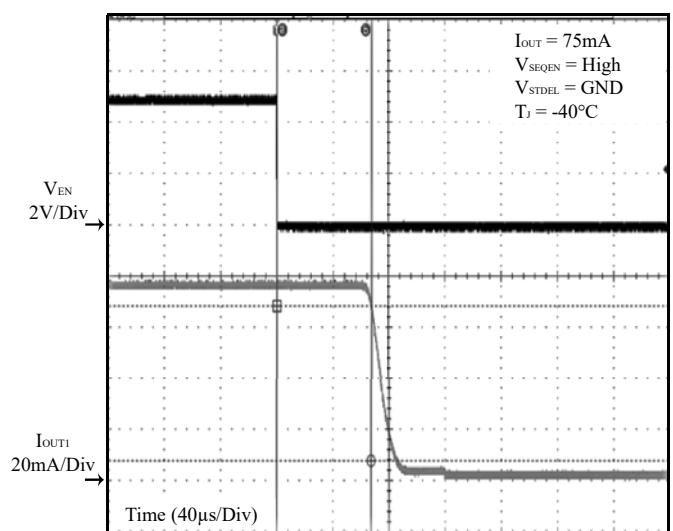

Figure 27 EN Off

IS32LT3146

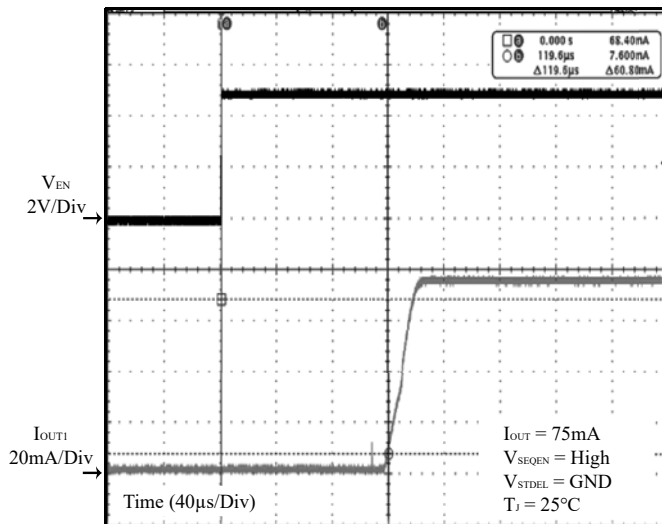

Figure 28 $t_{STDELMIN}$

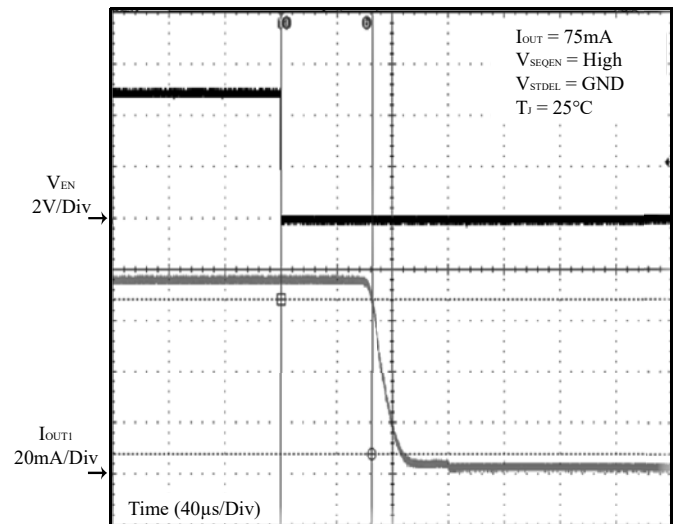

Figure 29 EN Off

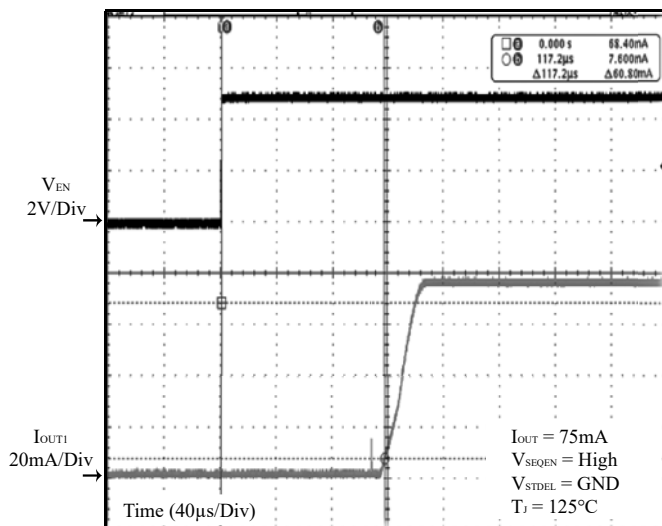

Figure 30 $t_{STDELMIN}$

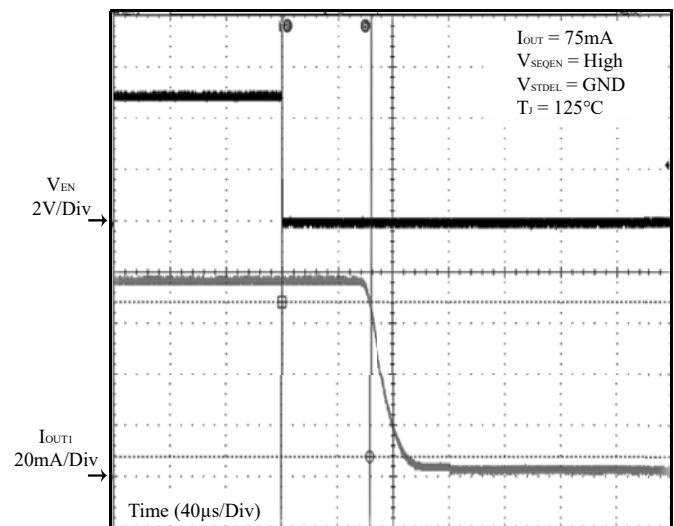

Figure 31 EN Off

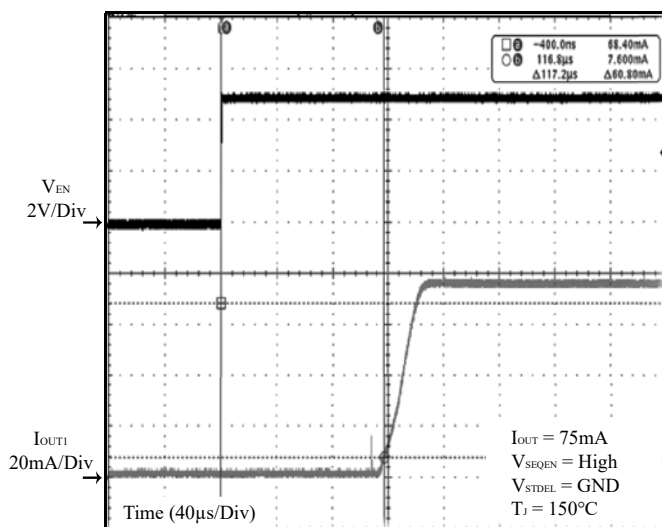

Figure 32 $t_{STDELMIN}$

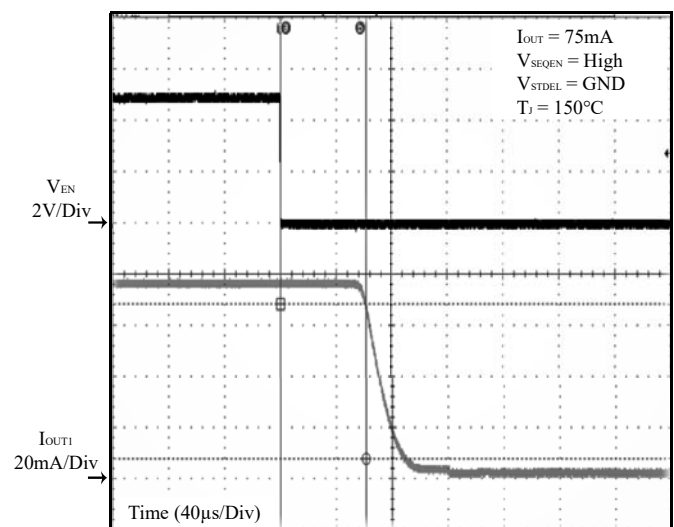
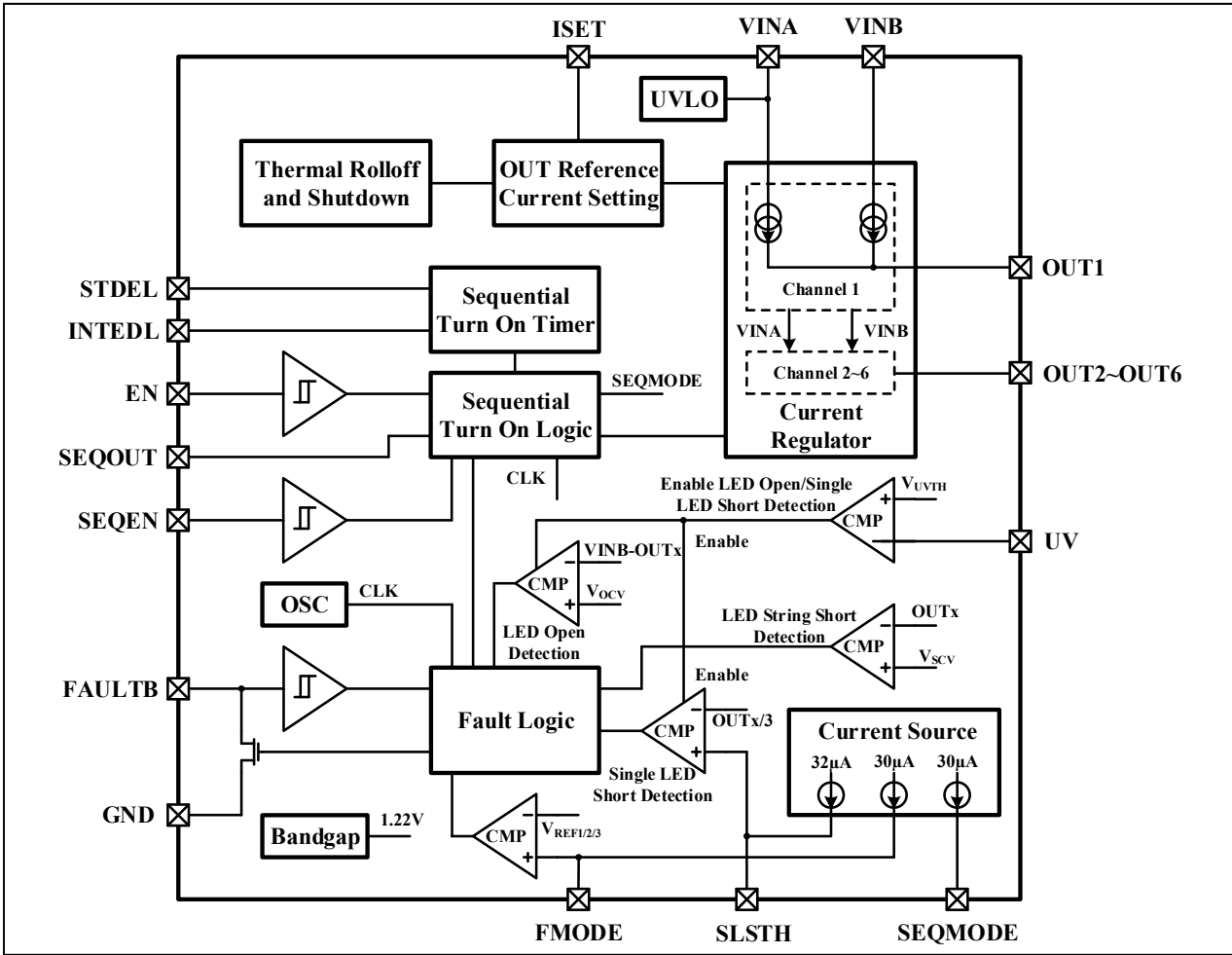

Figure 33 EN Off

IS32LT3146

FUNCTIONAL BLOCK DIAGRAM



IS32LT3146

APPLICATION INFORMATION

The IS32LT3146 device is a six-channel linear LED driver with an integrated state machine to implement both traditional blink display mode or sequential turn on display mode (Dynamic Turn Light) of LEDs without the need for a microcontroller.

The display mode is selected by the logic level of the SEQEN pin. The state machine detects the logic level of the SEQEN pin upon the EN pin toggling high. If the SEQEN pin is logic low, all channels will be turned on simultaneously, and pulling EN pin low will simultaneously turn off all channels to implement traditional blink display mode. If the SEQEN pin is logic high, an internal timer is triggered to start counting to implement sequential turn on mode. The device will sequentially turn on the output channels by the internal timer until all channels are turned on. The startup delay time of EN rising edge to first channel output current rising edge, and channel to channel internal delay time of the sequential turn on are fully programmable by external resistors, no software program is required. Then pulling EN pin low will simultaneously turn off all channels.

When a display mode is in progress, it will not be interrupted to switch mode by the SEQEN pin logic until EN pin toggles high. The sequential turn on mode is able to implement multiple devices synchronization operation to realize more than 6 strings LED sequential turn on. A single resistor from the SEQMODE pin to GND can select sequential turn on styles: one channel by one channel, two channels by two channels, three channels by three channels or all channels simultaneous on; thus facilitating tying multiple channels in parallel to drive higher current LEDs.

UNDERVOLTAGE-LOCKOUT (UVLO)

IS32LT3146 features an undervoltage-lockout (UVLO) function on the VINA pin to prevent misoperation at input voltages that is too low. UVLO threshold is an internally fixed value and cannot be adjusted. The device is enabled when the VINA voltage exceeds V_{INA_UV} (Typ. 4.7V), and disabled when the VINA voltage falls below (V_{INA_UV}-V_{INA_UVHY}) (Typ. 4.42V).

OUTPUT CURRENT SETTING

The regulated LED current (up to 75mA) from each channel is simultaneously set by the resistor (R_{ISET}) from ISET pin to GND. The programming resistor is computed using the following equation:

$$R_{ISET} = \frac{V_{ISET}}{I_{OUT}} \times 404 \quad (1)$$

(6.2kΩ ≤ R_{ISET} ≤ 46.5kΩ) and V_{ISET} = 1.15V (Typ.). Where, R_{ISET} is in Ω and I_{OUT} is in Amp.

It is recommended that R_{ISET} be a 1% accuracy resistor with good temperature characteristic to ensure stable output current. The R_{ISET} must be placed as close to ISET pin as possible on PCB layout to avoid noise interference and ground bounce.

The device is protected from an output overcurrent condition caused by R_{ISET} resistor. The output current is limited to an I_{OUT_L} value of 120mA (Typ.) if the ISET pin is shorted or R_{ISET} resistor value is too low.

If any channel(s) are unused, please connect the corresponding OUTx pin to the VINB pin directly to avoid false fault detection.

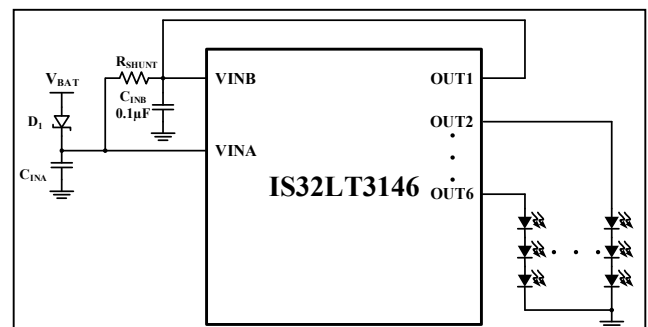

Figure 34 OUT1 Unused

THERMAL SHUNT TOPOLOGY

For any linear constant current LED driver, the power dissipation of the driver always depends on the voltage drop across the driver.

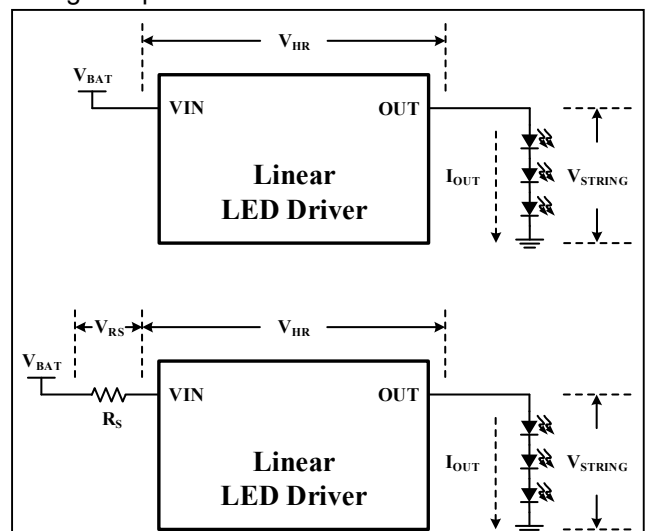

Figure 35 Linear LED Driver Power Dissipation

As in Figure 35, the power dissipation of the driver can be calculated by following equation:

$$P_{DRIVER} = V_{HR} \times I_{OUT} = (V_{BAT} - V_{STRING}) \times I_{OUT} \quad (2)$$

According to above equation, a higher input voltage will result in more driver power. A power resistor, R_S, can be added to shunt some power away from the

IS32LT3146

driver. The resultant driver power dissipation becomes:

$$P_{DRIVER} = V_{HR} \times I_{OUT} \quad (3)$$

$$= (V_{BAT} - R_S \times I_{OUT} - V_{STRING}) \times I_{OUT}$$

Where it assumes the internal circuit current consumption of the linear LED driver is negligible compared to I_{OUT} . Hence, I_{VIN} is equal to I_{OUT} .

A large R_S value is able to significantly derate the power dissipation on the driver at high input voltage level. However, in the automotive applications, the nominal battery voltage is quite a wide range of about 9V to 16V. An R_S that is too large will result in insufficient headroom voltage for the driver at low input voltage level so the output current will drop down. To solve that, IS32LT3146 features an excellent thermal shunt mechanism to efficiently shunt as much power dissipation as possible from the driver to the power resistor. It provides two current input paths, VINA pin and VINB pin. VINA is connected directly to the power supply and VINB is connected to the power supply via a thermal shunt resistor in series as in below Figure.

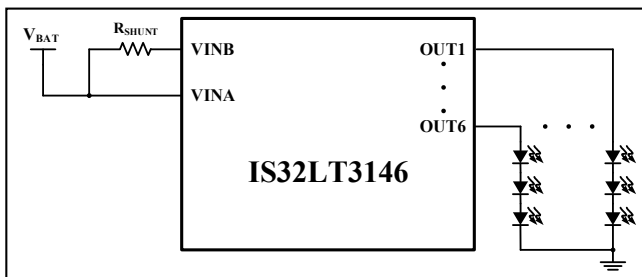

Figure 36 Thermal shunt Topology

This thermal shunt mechanism ensures the input current flows through the VINB path as much as possible. However, when the input voltage, V_{BAT} , is at a low level, the thermal shunt resistor R_{SHUNT} limits the input current through the VINB path so the major input current flows through the VINA path directly to ensure sufficient headroom voltage for the driver to maintain constant output current. When the input voltage V_{BAT} increases, the device gradually transfers more input current from VINA path to VINB path. The higher V_{BAT} voltage level, the more current flows through the VINB path. So the R_{SHUNT} can significantly shunt the power dissipation from the driver at high input voltage level and ensure the junction temperature of the driver remains at a reasonable level. If the thermal shunt mechanism is not implemented, connect both of VINA and VINB pins directly to the power supply.

As shown in Figure 37, IS32LT3146 has different operating areas when using the thermal shunt mechanism. Within the Low Headroom Area, the input voltage is too low. Even though all input current flows through the VINA path, the headroom voltage still is insufficient to reach the setting value. So the power dissipation of the driver is small. When the input

voltage rises above $(V_{OUT_MAX} + V_{HR_MIN})$, the transition voltage V_{TR} splits the operation into two areas: Thermal Shunt Area and Thermal Increasing Area.

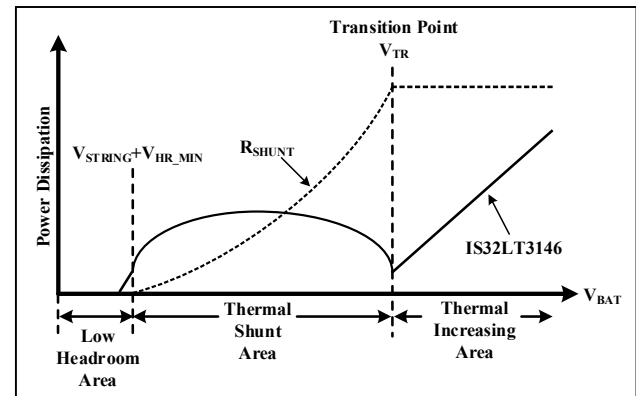

Figure 37 Power Dissipation Distribution

Thermal Shunt Area:

When the input voltage rises above $(V_{OUT_MAX} + V_{HR_MIN})$, all output current becomes constant and the major input current starts to be gradually transferred from the VINA path to the VINB path as the input voltage increases. Therefore, the power dissipation on R_{SHUNT} increases and the power dissipation of the driver remains at reasonable low level. The VINB path current can be calculated by:

$$I_{VINB} = \frac{V_{BAT} - V_{OUT_MAX} - V_{HR_MIN}}{R_{SHUNT}} \quad (4)$$

Where, V_{OUT_MAX} is the maximum voltage of all OUT_x pins. V_{HR_MIN} is the minimum headroom voltage.

So the VINA path current is:

$$I_{VINA} = (I_{OUT} \times N - I_{VINB}) + I_{IN} \quad (5)$$

Where, I_{IN} is the power supply quiescent current and N is the number of the channels in use.

The power dissipation on the R_{SHUNT} resistor is:

$$P_{SHUNT} = \frac{(V_{BAT} - V_{OUT_MAX} - V_{HR_MIN})^2}{R_{SHUNT}} \quad (6)$$

The power dissipation on IS32LT3146 is:

$$P_{3146_TSA} = V_{BAT} \times (I_{OUT} \times N + I_{IN}) - \frac{(V_{BAT} - V_{OUT_MAX} - V_{HR_MIN})^2}{R_{SHUNT}} \quad (7)$$

$$\sum_{x=1}^N (I_{OUT} \times V_{OUTx})$$

Thermal Increasing Area:

When the input voltage is high enough, equal or greater than the Transition Voltage V_{TR} , all input current flows through R_{SHUNT} into VINB pin. The power dissipation on the R_{SHUNT} resistor is constant. And the

IS32LT3146

power dissipation on the driver increases linearly. V_{TR} voltage point can be adjusted by the resistance value of R_{SHUNT} .

$$V_{TR} = R_{SHUNT} \times I_{OUT} \times N + V_{OUT_MAX} + V_{ABTR} \quad (8)$$

To optimize the power dissipation on the driver, R_{SHUNT} value should be chosen to make sure the V_{TR} is equal to the maximum input voltage, recommend 16V for 12V system automotive applications.

$$R_{SHUNT_16V} = \frac{16V - V_{OUT_MAX} - V_{ABTR}}{I_{OUT} \times N} \quad (9)$$

Where, R_{SHUNT_16V} is the thermal shunt resistor value to make $V_{TR}=16V$. V_{ABTR} is the voltage threshold of input current full transition from V_{INA} path to V_{INB} path. N is the number of the channels in use.

However, the larger the R_{SHUNT} value with low V_{INA} results in low drop out voltage from the V_{INB} pin to the $OUTx$ pin. Since the LED string open protection is achieved by detecting this drop out (refer to the “LED STRING OPEN PROTECTION” section), a large R_{SHUNT} value could falsely trigger the LED string open protection when the input voltage V_{BAT} is at a low level. To prevent falsely triggering, a proper fault undervoltage-lockout voltage threshold V_{FLT_UVLO} should be set. It is recommended to be set at the larger value of the maximum voltage of all $OUTx$ pins plus 1.5V margin or 9V (refer to the “UV PIN FUNCTION” section). Therefore, the maximum power shunt resistor value that can be chosen is limited by the V_{FLT_UVLO} value. It can be calculated by:

$$R_{SHUNT_MAX} = \frac{V_{FLT_UVLO} - V_{OUT_MAX}}{6mA \times N} \quad (10)$$

Where, 6mA is a typical output current level through V_{INB} path, below which the drop out voltage ($V_{INB} - V_{OUTx}$) would be too low and falsely trigger the LED string open fault protection and N is the number of the channels in use.

If the calculated R_{SHUNT_16V} is lower than the calculated R_{SHUNT_MAX} , then the final R_{SHUNT} value should be set to R_{SHUNT_16V} otherwise set it to R_{SHUNT_MAX} .

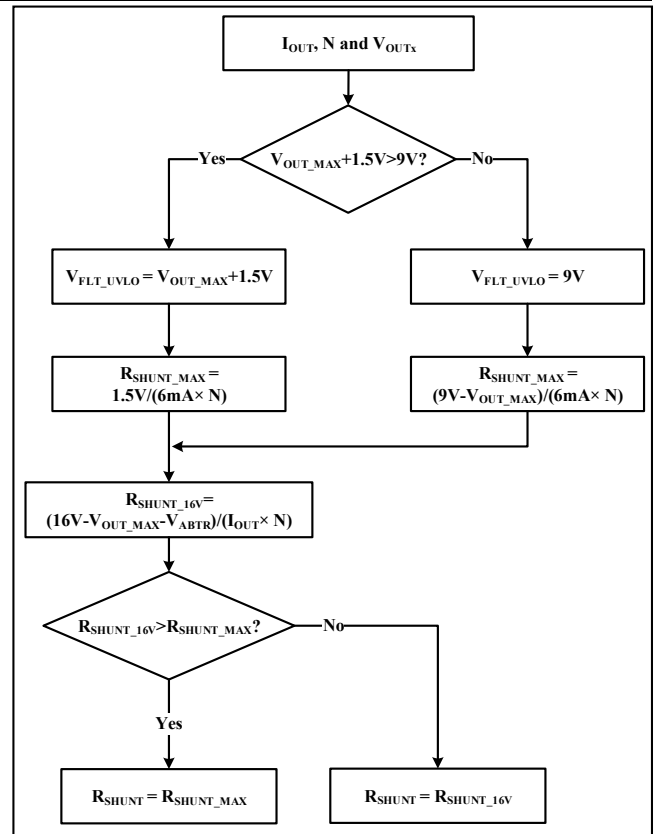

Figure 38 R_{SHUNT} Calculation Flowchart

The power dissipation on IS32LT3146 is:

$$P_{3146_TIA} = V_{BAT} \times (I_{OUT} \times N + I_{IN}) - R_{SHUNT} \times (I_{OUT} \times N)^2 - \sum_{X=1}^N (I_{OUT} \times V_{OUTx}) \quad (11)$$

The power dissipation on the R_{SHUNT} resistor is constant at maximum value which can be calculated by:

$$P_{SHUNT_MAX} = R_{SHUNT} \times (I_{OUT} \times N)^2 \quad (12)$$

The power rating of R_{SHUNT} should be carefully considered. A single high wattage resistor or several small wattage resistors in parallel can be used to sustain the power dissipation.

DEVICE ENABLE AND SHUTDOWN

The EN pin is an enable input for the device, pull it higher than V_{IH} to enable the device; pull it lower than V_{IL} to turn off all channels and force the device into shutdown mode with a low standby current. The EN pin is high-voltage tolerant, however, if the EN pin voltage is possibly higher than the V_{INA} and V_{INB} pins voltage at any time, a series resistor (recommended value is 10k Ω) is required to limit the current flowing into the EN pin. Since the V_{INB} pin voltage may be regulated down close to the LED string forward voltage by the thermal shunt mechanism, a series resistor for EN pin must be added in most applications.

IS32LT3146

TURN LIGHT APPLICATION

In the turn light applications, there is a BCM (Body Control Module) ON/OFF blink signal which can be applied to the EN pin of IS32LT3146 via a 10kΩ resistor and an independent static power supply rail can be used to supply the VINA pin of IS32LT3146, as shown in (1) of Figure 39. Unfortunately, in most turn light applications, there is no independent static power supply rail but only the BCM ON/OFF blink signal which plays the power supply role as well. If so, the BCM ON/OFF blink signal can be directly applied to the VINA pin with the EN pin tied to the VINA pin via a 10kΩ resistor, as shown in (2) of Figure 39. Where, the D₁, D₂ and D₃ are reverse polarity protection diodes.

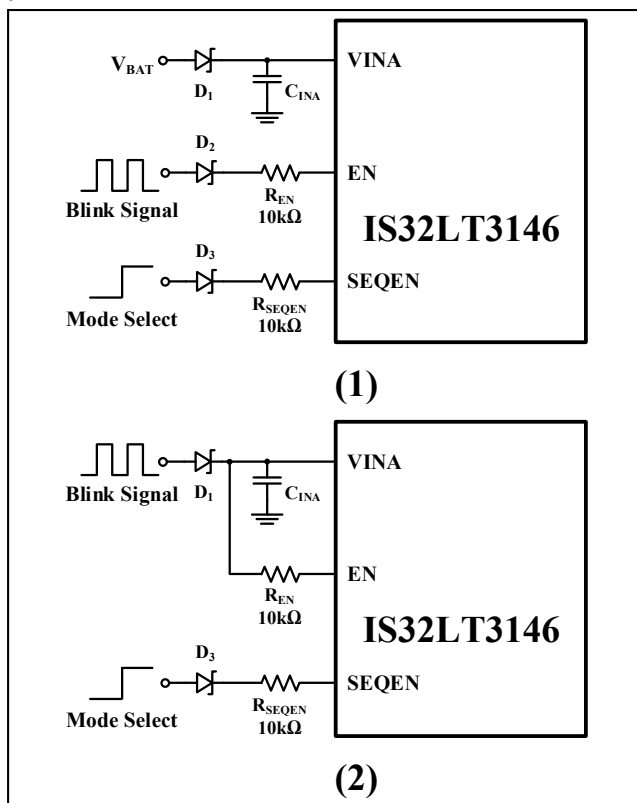

Figure 39 BCM Blink Signal Connection

IS32LT3146 is capable of supporting both traditional blink display mode and sequential turn on display mode, which are selected by the logic level of the SEQEN pin. When the EN pin is pulled high, the device samples the logic level of the SEQEN pin 47μs (Typ.) after the EN pin voltage rising edge to determine the display mode. And the internal state machine of the output on control is active at 110μs (Typ.) after the EN pin voltage rising edge as in Figure 40. Therefore, to get the desired display mode, the logic state change of the SEQEN pin should not be implemented after the EN pin rising edge. Compared to the time period of the BCM ON/OFF blink signal (around 500ms), this detection delay time is negligible and ignored in subsequent descriptions and figures.

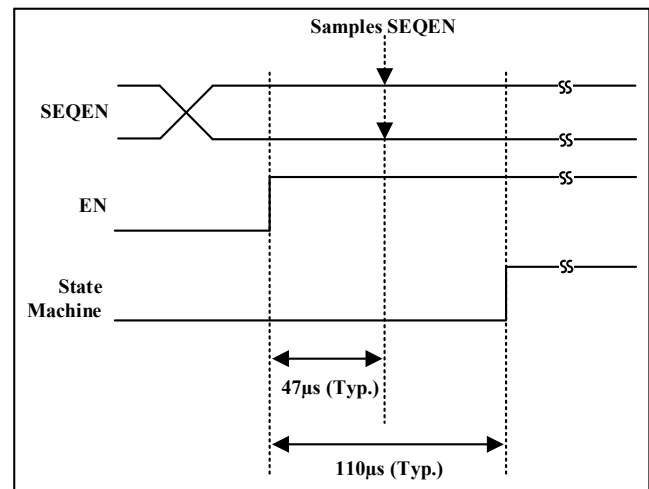

Figure 40 Display Mode Detection

Traditional Blink Display Mode

If the sampling result of the SEQEN pin is logic low, the state machine will turn on all channels at 110μs (Typ.) after the EN pin rising edge until the EN pin is pulled low. To optimize power supply ripple and ground bounce, the traditional blink mode integrates a 20μs (Typ.) on/off delay between channel to channel. Compared to the time period of the BCM ON/OFF blink signal (around 500ms), this 20μs (Typ.) turning on/off delay time is negligible and ignored in subsequent description and figures. As in Figure 41, the on/off delay time is ignored and illustrated diagram imply the EN pin logic directly controls the on/off of all channels. All LEDs will be turned on and off following the blink signal to implement traditional blink display mode.

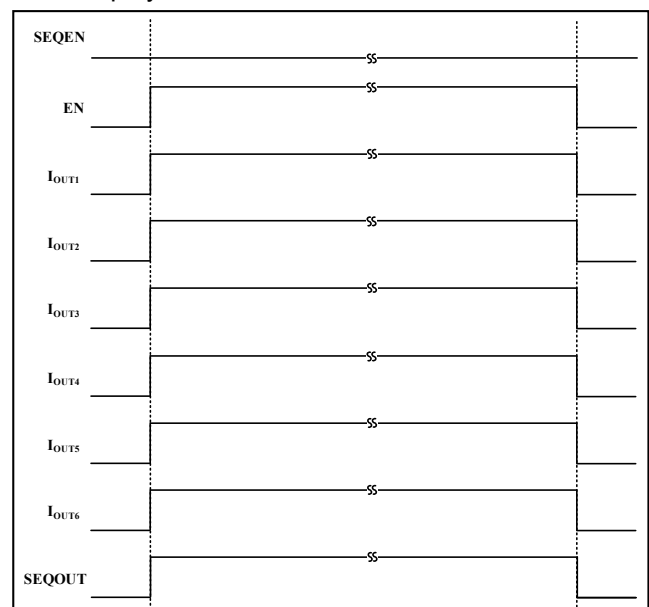

Figure 41 Traditional Blink Display Mode

Sequential Turn On Display Mode

If the sampling result of the SEQEN pin is logic high, a startup delay timer of the internal state machine is

IS32LT3146

triggered to start counting at 110µs (Typ.) after the rising edge of the EN pin voltage, all channels stay off until the startup delay time expires. The startup delay time t_{STDEL} is set by a single resistor R_{STDEL} connected from the STDEL pin to GND:

$$R_{STDEL} = \frac{t_{STDEL} + 12.14}{6.829} \quad (13)$$

(9.1kΩ ≤ R_{STDEL} ≤ 75kΩ)

Where, R_{STDEL} is in kΩ and t_{STDEL} is in ms. The recommended setting range of the startup delay time is 50ms to 500ms. If the startup delay time isn't needed, please connect the STDEL pin to GND directly to disable it.

Once the startup delay time is expired, the internal state machine starts to sequentially turn on the output channels with an identical interval delay time. The interval delay time t_{INTDEL} is set by a single resistor R_{INTDEL} connected from the INTDEL pin to GND:

$$R_{INTDEL} = \frac{t_{INTDEL} + 2.43}{1.366} \quad (14)$$

(9.1kΩ ≤ R_{INTDEL} ≤ 75kΩ)

Where, R_{INTDEL} is in kΩ and t_{INTDEL} is in ms. The recommended setting range of the interval delay time is 10ms to 100ms.

It is recommended that R_{STDEL} and R_{INTDEL} be 1% accuracy resistors with good temperature characteristic to ensure stable and precise timing. The R_{STDEL} and R_{INTDEL} must be placed as close to the corresponding pins as possible on PCB layout to avoid noise interference and ground bounce.

During the device sequentially turn on of the output channels, pulling the EN pin low can simultaneously shutdown all channels and reset the internal state machine at any time. The startup delay time and interval delay time should be properly set to ensure that all channels are turned on for a while before the EN pin is pulled low to implement the Dynamic Turn Light effect as in below Figure 42. The IS32LT3146 repeats the sequential turn on display for every blink signal ON phase.

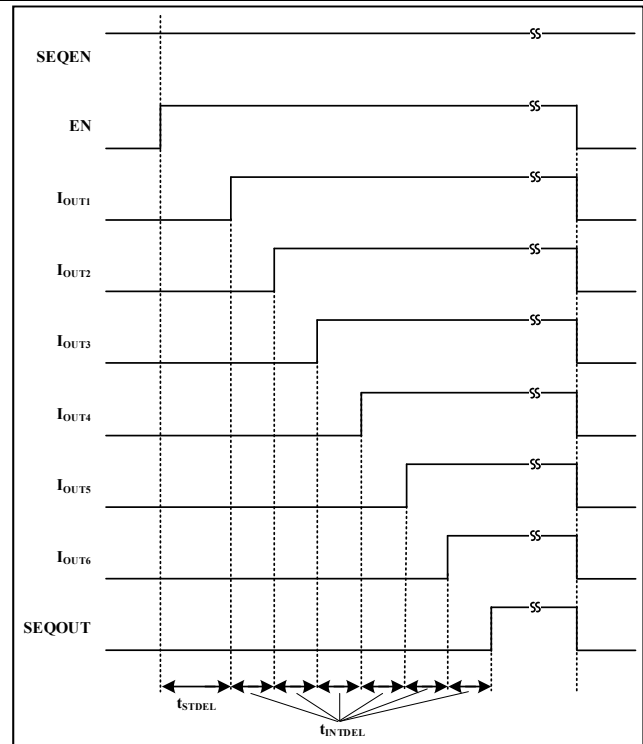

Figure 42 Sequential Turn On Display Mode

If any channel is unused, the corresponding OUTx pin should be connected to the VINB pin directly. The unused channel will be skipped from sequencing and subsequent channels will be pulled-in in time. For example, assume the OUT3 channel is unused, all subsequent channels, OUT4~OUT6, are pulled-in in time to ensure that the interval time between the OUT2 and the OUT4 satisfy the setting interval delay time t_{INTDEL} as in Figure 43.

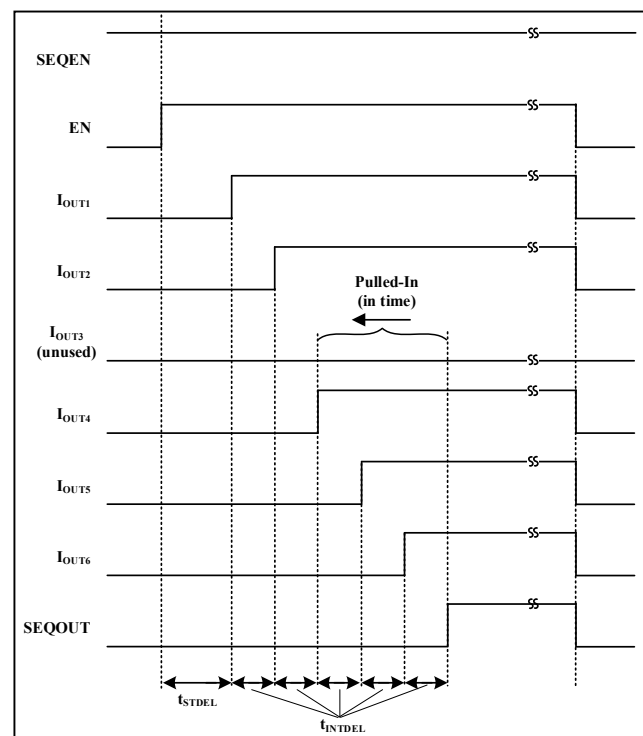

Figure 43 Sequential Turn On Display with Channel Unused

IS32LT3146

The sequential turn on display mode has 4 programmable styles: one by one, two by two, three by three or all simultaneous on, which is selected by a proper valued resistor, R_{SEQMD} , connected from the SEQMODE pin to GND. It is recommended that R_{SEQMD} be a 1% accuracy resistor with good temperature characteristic to ensure stability as shown in Figure 45.

Table 1 R_{SEQMD} Resistance Versus Styles

$R_{SEQMD}(k\Omega)$	Sequential Turn On Style
0	One by One
27	Two by Two
62	Three by Three
150	All Simultaneous On

Whatever style is used, the startup delay time and interval delay time are always determined by the R_{STDEL} and R_{INTDEL} resistors. The simultaneously on channels can be combined in parallel to drive higher current LEDs.

Since the SEQEN pin logic level is only sampled at the voltage rising edge of the EN pin, the logic level of the SEQEN pin can be changed when a display mode is in progress, and the display mode will not be interrupted until next EN rising edge to sample the

SEQEN pin logic level again (next BCM ON cycle) as shown in Figure 46.

If the application doesn't require to change the display mode, connect SEQEN pin to GND directly for traditional blink mode or connect to VINA via a 10k Ω resistor for sequential turn on mode. The SEQEN pin is high-voltage tolerant, however, if the SEQEN pin voltage is possibly higher than the VINA and VINB pins voltage at any time, a series resistor (recommend 10k Ω) is required to limit the current flowing into the SEQEN pin. Since the VINB pin voltage may be regulated down close to the LED string forward voltage by the thermal shunt mechanism, a series resistor for SEQEN pin must be added in most applications as shown in Figure 44.

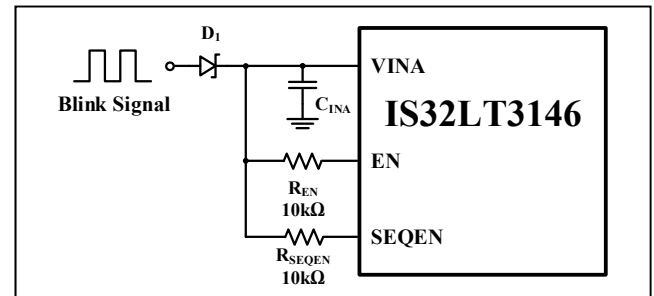

Figure 44 SEQEN Pin Connection for Sequential Turn On Display Mode Only

IS32LT3146

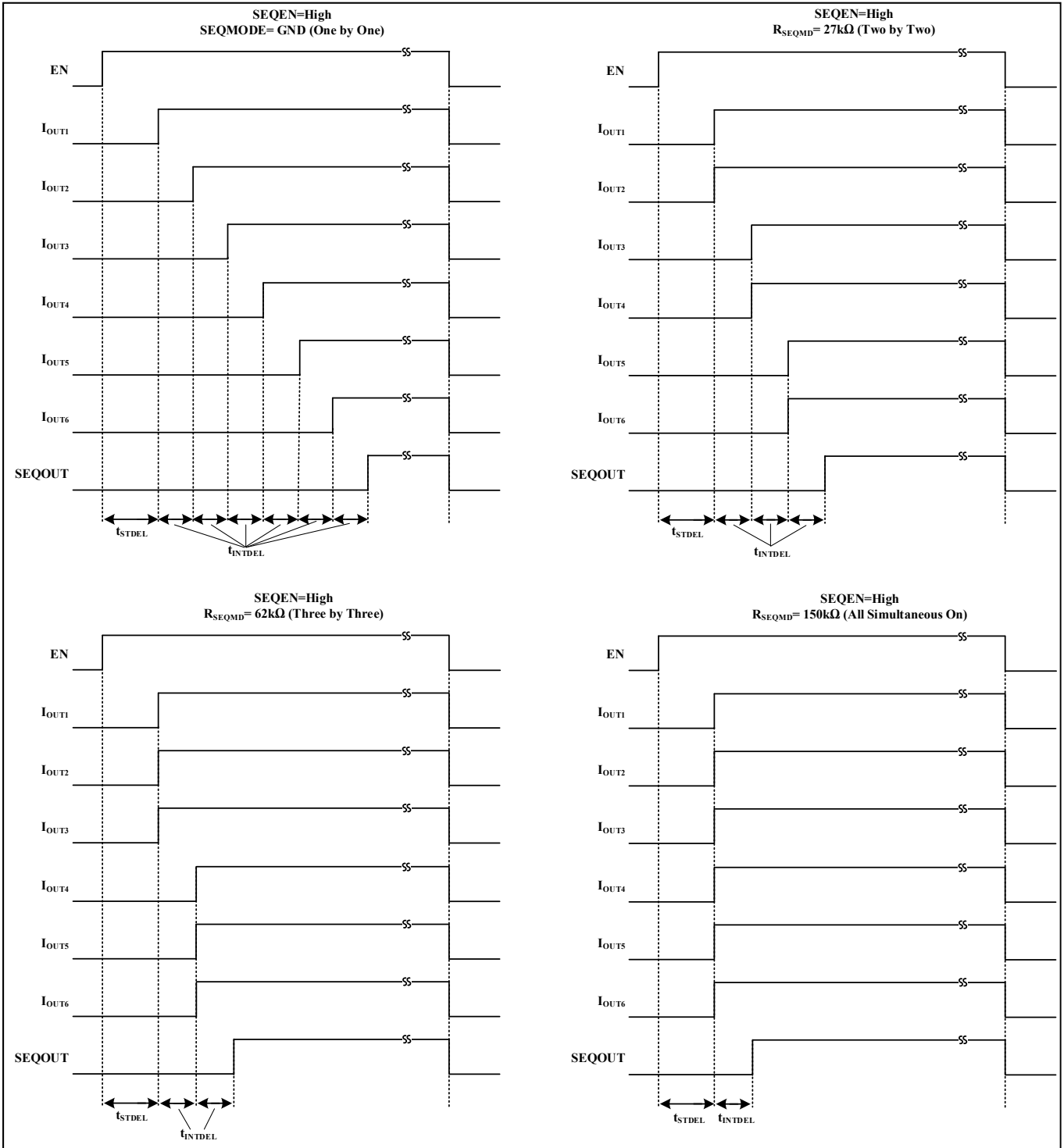

Figure 45 Sequential Turn On Mode (4 Styles)

IS32LT3146

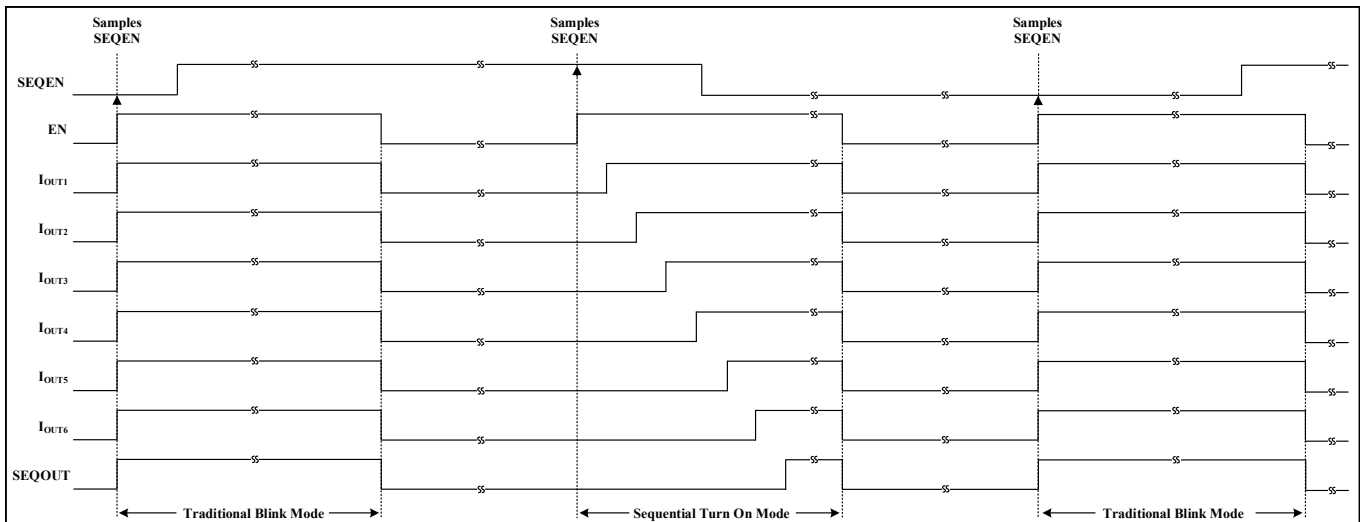

Figure 46 Display Mode Switch

MULTIPLE DEVICES SEQUENTIAL TURN ON OPERATION

If the system needs more channels for sequential turn on operation, multiple IS32LT3146 devices can be used to implement synchronized sequential turn on display. IS32LT3146 supports synchronization through an additional synchronization signal connection or stand-alone mode. When the IS32LT3146 devices are placed on same physical PCB board, then Synchronization Mode can be chosen. When the IS32LT3146 devices are placed on two or more different physical PCB boards and additional cables connecting the PCB boards are not allowed, then Stand-alone Mode can be chosen.

Synchronization Mode

As shown in Figure 3, synchronization mode is realized by synchronization signal daisy chain connection, connecting previous device's SEQOUT pin to the EN pin of subsequent device. The first device is enabled by the BCM ON/OFF blink signal connected to its EN pin.

The SEQOUT pin pulls high at an interval delay time after the last channel of the corresponding device turned on and pulls low once the EN pin of the corresponding device being pulled low as illustrated in Figure 47. The SEQOUT pin output is utilized to enable the subsequent device and implement consistent sequential turn on display. The startup

delay time of all devices should be set to “zero” (STDEL pin grounded to disable the startup delay time) and the interval delay time of all devices should be set to the same value.

Likewise, the other operation styles can use the synchronization mode as well to support higher current LEDs.

Stand-Alone Mode

As shown in Figure 2, there is no synchronization signal daisy chain connection needed among devices. The SEQOUT pins of all devices are left floating and the EN pins of all devices must be connected to the same BCM ON/OFF blink signal. The startup delay time of the first device is set to “zero” (STDEL pin grounded to disable the startup delay time). The startup delay time of the subsequent devices are set according to the total sequential turn on time of the previous devices. The interval delay time of all devices should be set to the same value as shown in Figure 48.

For example, if each device uses 6 channels, the startup delay time of #N device should be set:

$$t_{STDEL} = t_{INTDEL} \times [(N-1) \times 6] \quad (15)$$

The consistency of the sequential turn on display is ensured by the accurate internal timer. Likewise, the other operation styles can use the stand-alone mode as well to support higher current LEDs.

IS32LT3146

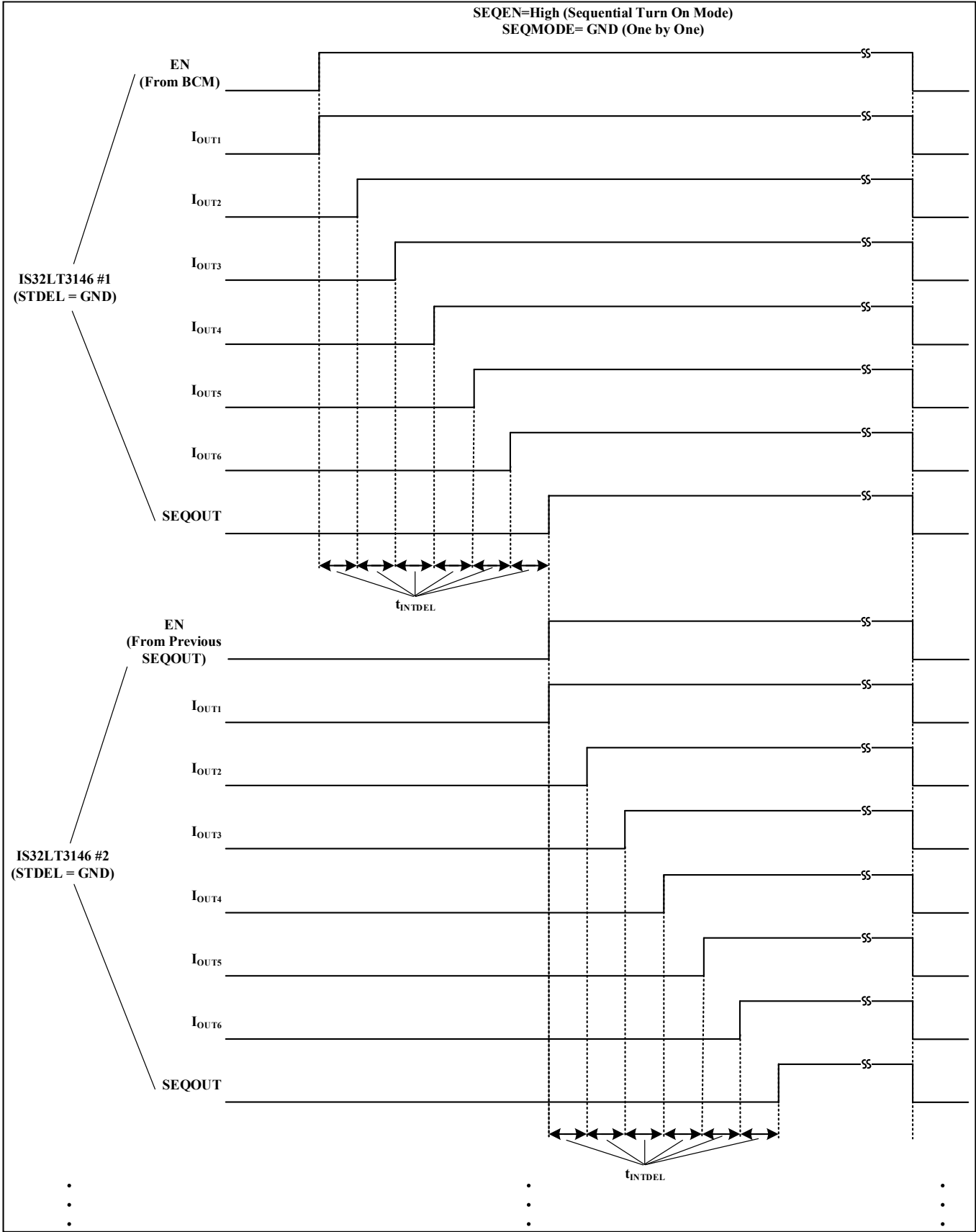

Figure 47 Synchronization Mode

IS32LT3146

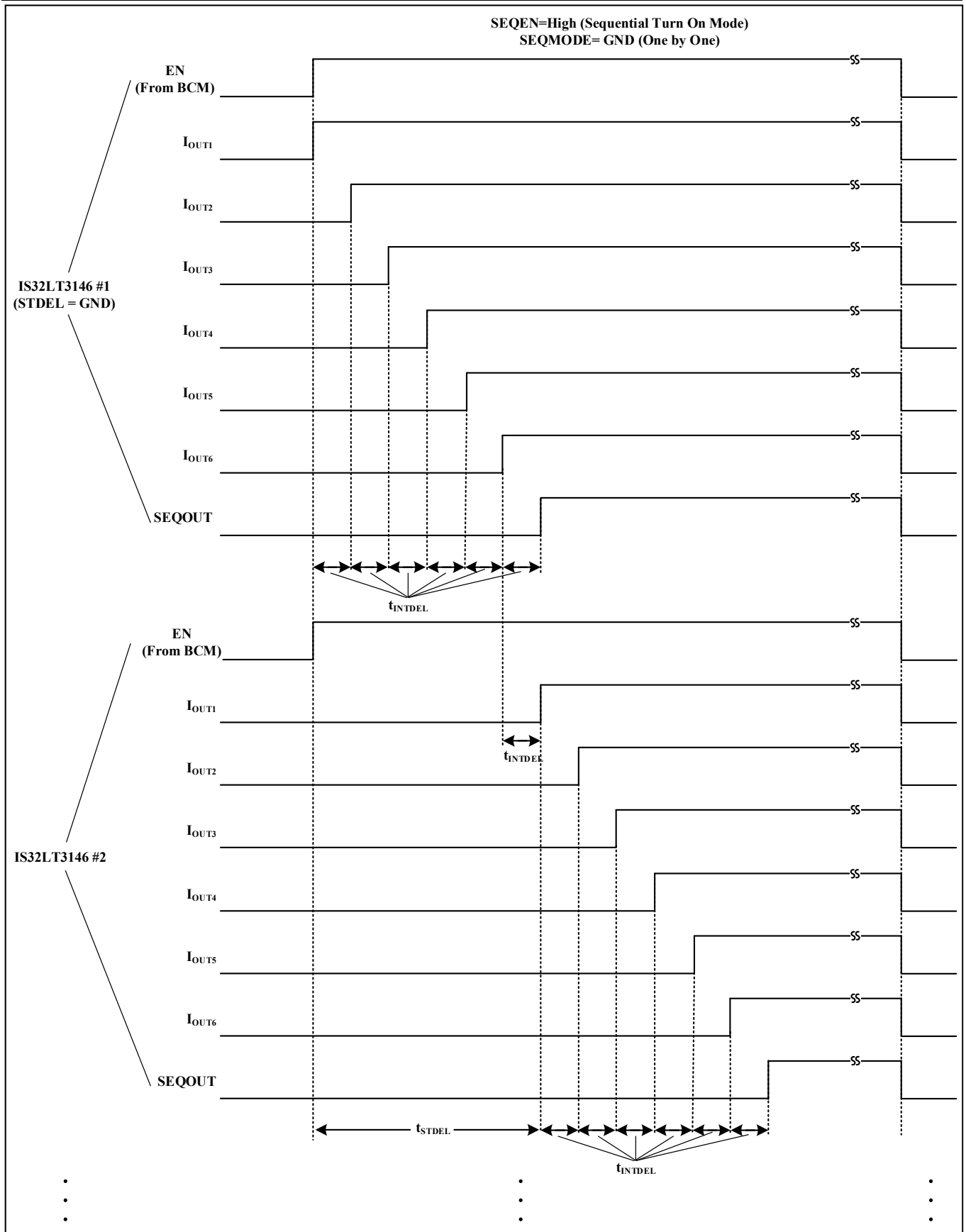

Figure 48 Stand-alone Mode

IS32LT3146

FAULT PROTECTION AND REPORTING

For robust system reliability, the IS32LT3146 integrates the detection circuitry to protect various fault conditions and report the fault conditions on the FAULTB pin which can be monitored by an external host. The fault protections include LED string open/shorted, single LED shorted, ISET pin open/shorted, thermal roll-off (not reported) and thermal shutdown. The FAULTB pin will go low when the device enables fault detection and detects a fault condition.

The FMODE is a fault action mode set pin. Connecting a proper valued resistor, R_{FMODE} , from this pin to GND selects various modes of action when faults are detected. Refer to Table 2 ~ Table 4. If $R_{FMODE} = 0\Omega$ or $27k\Omega$, the fault action is in “One Fail All Fail” mode which means any channel encounters fault then all other normal channels will be turned off. The FAULTB pin supports both input and output functions. If $R_{FMODE} = 62k\Omega$ or $150k\Omega$, the fault action is in “One Fail Other On” mode which means any channel encounters fault then all other normal channels will keep normal operation. The FAULTB pin supports output function only.

Table 2 R_{FMODE} Resistance Versus Fault Actions

$R_{FMODE}(k\Omega)$	Fault Action	Single LED Short
0	One Fail All Fail Mode	Retry Current in Faulty Channel
27		Latched Off Device
62	One Fail Other On Mode	Retry Current in Faulty Channel
150		Fully On

In the “One Fail All Fail” mode, the FAULTB pin supports both input and output functions. Externally pulling FAULTB pin low will disable the output, so the FAULTB pin is not allowed to float in this mode. An external resistor, R_{FAULTB} , must be added to pull up FAULTB pin above 2.3V for normal operation. The recommended resistor value is 47k Ω . For lighting systems with multiple IS32LT3146 drivers which requires the complete lighting system be shut down when a fault is detected, the FAULTB pin can be used in a parallel connection. A fault output by one device will pull low the FAULTB pins of the other parallel connected devices and simultaneously turn them off. This satisfies the multiple devices “One Fail All Fail” operating requirement.

UV PIN FUNCTION

The UV pin with a resistor divider from VINA is to program a undervoltage-lockout voltage threshold for LED string open and single LED shorted fault detections. That helps to prevent false fault detection due to the insufficient power supply voltage, such as power up transience. The UV pin voltage is higher

than V_{UVTH} to enable these fault detections and lower than $(V_{UVTH}-V_{UVTH_HY})$ to disable.

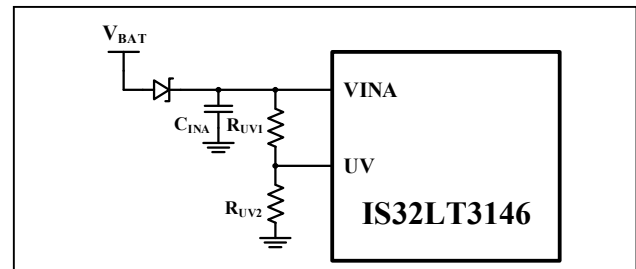

Figure 49 Externally UVLO for Fault Detection

The fault undervoltage-lockout voltage threshold can be computed using the following:

$$V_{FLT_UVLO} = V_{UVTH} \times \frac{R_{UV1} + R_{UV2}}{R_{UV2}} \quad (16)$$

To prevent false fault triggering, the fault undervoltage-lockout voltage threshold should be set at the larger of the maximum voltage of all OUTx pins plus 1.5V margin or 9V (the minimum input voltage of 12V system):

$$V_{FLT_UVLO} = \max\{V_{OUT_MAX} + 1.5V, 9V\} \quad (17)$$

Where V_{OUT_MAX} is the maximum voltage of all OUTx pins.

LED STRING OPEN PROTECTION

The LED string open detection is enabled after VINA voltage rising above a setting fault undervoltage-lockout voltage threshold, V_{FLT_UVLO} . If any LED string is open, the corresponding OUTx pin will be pulled up close to VINB by its internal current source. When $V_{INA} > V_{FLT_UVLO}$ and the drop out voltage from the VINB pin to the OUTx pin, $(V_{INB}-V_{OUTx})$, falls below the LED string open detection voltage, V_{OCV} , and persists for longer than the fault reporting delay time t_{FDEL} (typical 2ms), the LED string open protection will be triggered and FAULTB pin will go low to report the fault condition. The faulty channel will reserve a retry current I_{RTR} for recovery detection. The R_{FMODE} value on the FMODE pin decides the fault action. If the $R_{FMODE} = 0\Omega$ or $27k\Omega$, the fault protection mode is “One Fail All Fail” mode, so all other normal channels will be turned off. If the $R_{FMODE} = 62k\Omega$ or $150k\Omega$, the fault protection mode is “One Fail Other On” mode which means that all other normal channels will keep normal operation. No matter in which fault protection mode, the device recovers to normal operation and the FAULTB pin will go back to high impedance once the open condition is removed, $(V_{INB}-V_{OUTx})$ rising above the LED string open detection voltage, $(V_{OCV}+V_{OCV_HY})$.

LED STRING SHORT PROTECTION

The LED string short condition is detected if any one of OUTx pins voltage is lower than LED string short

IS32LT3146

detection voltage, V_{SCV} . Once short condition occurs and persists for longer than the fault reporting delay time t_{FBDEL} (typical 2ms), the LED string short protection will be triggered and the FAULTB pin will go low to report the fault condition. The faulty channel will reserve a retry current I_{RTR} for recovery detection. The fault action is decided by the R_{FMODE} resistor as well. If the $R_{FMODE} = 0\Omega$ or $27k\Omega$, the fault protection mode is “One Fail All Fail” mode, so all other normal channels will be turned off. If the $R_{FMODE} = 62k\Omega$ or $150k\Omega$, the fault protection mode is “One Fail Other On” which means that all other normal channels will keep normal operation. No matter in which fault protection mode, the device will recover to normal operation and FAULTB pin will go back to high impedance once the short condition is removed, the OUTx pin voltage rising above the LED string short detection voltage, $(V_{SCV}+V_{SCV_HY})$.

SINGLE LED SHORT DETECTION

The IS32LT3146 supports single LED short detection which is implemented by detecting the OUTx pins voltage. The detection is enabled/disabled by UV pin as well to prevent false triggers due to insufficient power supply VINA. The detection voltage threshold is set by a resistor R_{SLSTH} connected from SLSTH pin to GND:

$$R_{SLSTH} = \frac{V_{SLSTH}}{3 \times I_{SLSTH}} \quad (18)$$

Where V_{SLSTH} is desired single LED short detection voltage threshold in Volt. The maximum V_{SLSTH} should not exceed 8.5V.

It is recommended that R_{SLSTH} be 1% accuracy resistor with good temperature characterization. The V_{SLSTH} should be properly chosen within:

$$N \times V_{f_MIN} > V_{SLSTH} > (N - 1) \times V_{f_MAX} \quad (19)$$

Where N is the number of LEDs used in the strings, V_{f_MAX} and V_{f_MIN} are the maximum and minimum forward voltage of LEDs used.

When $V_{INA} > V_{FLT_UVLO}$ and any one of the OUTx pins voltage drops below V_{SLSTH} but above LED string short detection voltage, V_{SCV} , for longer than the fault reporting delay time t_{FBDEL} (typical 2ms), the single LED short protection will be triggered and FAULTB pin will go low to report the fault condition. The fault action also is decided by the R_{FMODE} resistor as in Table 2.

In the “One Fail All Fail” mode, all other normal channels will be turned off. If the $R_{FMODE} = 0\Omega$, the faulty channel will reserve a retry current I_{RTR} for recovery detection. If the $R_{FMODE} = 27k\Omega$, the device will latch-in completely off state, including the faulty channel, until next power cycle.

In the “One Fail Other On” mode, all other normal channels will keep normal operation. If the $R_{FMODE} = 62k\Omega$, the faulty channel will reserve a retry current I_{RTR} for recovery detection as well. If the $R_{FMODE} = 150k\Omega$, the faulty channel will be fully on; therefore all channels are fully on while fault condition is reported. Besides the latched-off mode of $R_{FMODE}=27k\Omega$, the device will recover to normal operation and the FAULTB pin will go back to high impedance once the single LED short condition is removed, and V_{OUTx} rising above the single LED short detection voltage, $(V_{SLSTH}+V_{SLSTH_HY})$.

If the single LED short protection is unused, please connect the SLSTH pin to ground.

ISET PIN OPEN/SHORT PROTECTION

If the ISET pin is open or the connected resistor is too large in value ($>R_{ISET_OC}$), and persists for longer than fault detection deglitch time t_{FBDT} , the ISET pin open protection will be triggered. All channels will be turned off and the FAULTB pin will go low to report the fault condition.

The device is protected from an output overcurrent condition caused by R_{ISET} resistor. All output current is limited to an I_{OUT_L} value of 120mA should the ISET pin be shorted or connected resistor value is too low ($<R_{ISET_SC}$). If the condition persists for longer than t_{FBDT} , the ISET pin short protection will be triggered. All channels will be turned off and the FAULTB pin will go low to report the fault condition.

Once the resistance from the ISET pin to GND resumes to normal range, all channels will recover to normal operation and the FAULTB pin will go back to high impedance.

THERMAL ROLL-OFF PROTECTION

The output current will be equal to the set value as long as the junction temperature of the IC remains below T_{RO} (Typ. $150^{\circ}C$). If the junction temperature exceeds this threshold, the output current of all channels will begin to reduce at a rate of about $3.7\%/^{\circ}C$ until thermal shutdown. Thermal roll-off protection won't be reported by the FAULTB pin.

THERMAL SHUTDOWN PROTECTION

In the event that the junction temperature exceeds T_{SD} (Typ. $175^{\circ}C$), all channels will go to the “OFF” state and FAULTB pin will pull low to report the fault condition. At this point, the IC presumably begins to cool off. Any attempt to toggle the outputs back to the source condition before the IC is cooled to below $(T_{SD}-T_{SDHY})$ (Typ. $155^{\circ}C$) will be blocked and the IC will not be allowed to restart. The FAULTB pin will recover to high impedance once the IC has cooled down.

IS32LT3146

Table 3 “One Fail All Fail” Mode Fault Actions

R _{FMODE} = 0Ω or 27kΩ (ONE-FAIL-ALL-FAIL)							
UV Pin	Fault Type	Fault Condition	Output State		FAULTB Pin (with Input Function)	Recovery	
V _{UV} < (V _{UV} TH - V _{UVTH_HY})	LED string open		Disabled				
	LED string short	V _{OUTx} < V _{SCV}	Faulty channel outputs I _{RTR} for recovery detection and other channels off		Pull low (If the FAULTB pins of multiple devices are tied together, all other devices will be off)	V _{OUTx} > (V _{SCV} + V _{SCV_HY})	
	Single LED short		Disabled				
	ISET open	ISET pin to GND resistance > R _{ISET_OC}	All channels off		Pull low (If the FAULTB pins of multiple devices are tied together, all other devices will be off)	ISET pin to GND resistance resumes to normal range	
	ISET short	ISET pin to GND resistance < R _{ISET_SC}	All channels off			ISET pin to GND resistance resumes to normal range	
	Thermal shutdown	T _J > T _{SD}	All channels off			T _J < (T _{SD} - T _{SDHY})	
	Thermal roll-off	T _J > T _{RO}	Output current of all channels linearly decreases toward zero following T _J increasing		High impedance (If the FAULTB pins of multiple devices are tied together, all other devices will be on)	T _J < T _{RO}	
V _{UV} > V _{UVTH_H}	LED string open	(V _{INB} - V _{OUTx}) < V _{OCV}	Faulty channel outputs I _{RTR} for recovery detection and other channels off		Pull low (If the FAULTB pins of multiple devices are tied together, all other devices will be off)	(V _{INB} - V _{OUTx}) > (V _{OCV} + V _{OCV_HY})	
	LED string short	V _{OUTx} < V _{SCV}	Faulty channel outputs I _{RTR} for recovery detection and other channels off			V _{OUTx} > (V _{SCV} + V _{SCV_HY})	
	Single LED short	V _{OUTx} < V _{SLSLTH}	R _{FMODE} = 0Ω	Faulty channel outputs I _{RTR} for recovery detection and other channels off		V _{OUTx} > (V _{SLSLTH} + V _{SLSLTH_HY})	
			R _{FMODE} = 27kΩ	All channels latched off		Power cycle	
	ISET open	ISET pin to GND resistance > R _{ISET_OC}	All channels off			ISET pin to GND resistance resumes to normal range	
	ISET short	ISET pin to GND resistance < R _{ISET_SC}	All channels off			ISET pin to GND resistance resumes to normal range	
	Thermal shutdown	T _J > T _{SD}	All channels off			T _J < (T _{SD} - T _{SDHY})	
	Thermal roll-off	T _J > T _{RO}	Output current of all channels linearly decreases toward zero following T _J increasing			High impedance (If the FAULTB pins of multiple devices are tied together, all other devices will be on)	T _J < T _{RO}

IS32LT3146

Table 4 “One Fail Other On” Mode Fault Actions

R _{FMODE} = 62kΩ or 150kΩ (ONE-FAIL-OTHER-ON)							
UV Pin	Fault Type	Fault Condition	Output State		FAULTB Pin (without Input Function)	Recovery	
V _{UV} < (V _{UV} TH - V _{UVTH_HY})	LED string open	Disabled					
	LED string short	V _{OUTx} < V _{SCV}	Faulty channel outputs I _{RTR} for recovery detection and other channels on		Pull low (If the FAULTB pins of multiple devices are tied together, all other devices will be on)	V _{OUTx} > (V _{SCV} + V _{SCV_HY})	
	Single LED short	Disabled					
	ISET open	ISET pin to GND resistance > R _{ISET_OC}	All channels off		Pull low (If the FAULTB pins of multiple devices are tied together, all other devices will be on)	ISET pin to GND resistance resumes to normal range	
	ISET short	ISET pin to GND resistance < R _{ISET_SC}	All channels off			ISET pin to GND resistance resumes to normal range	
	Thermal shutdown	T _J > T _{SD}	All channels off			T _J < (T _{SD} - T _{SDHY})	
	Thermal roll-off	T _J > T _{RO}	Output current of all channels linearly decreases toward zero following T _J increasing		High impedance (If the FAULTB pins of multiple devices are tied together, all other devices will be on)	T _J < T _{RO}	
V _{UV} > V _{UVTH_H}	LED string open	(V _{INB} - V _{OUTx}) < V _{OCV}	Faulty channel outputs I _{RTR} for recovery detection and other channels on		Pull low (If the FAULTB pins of multiple devices are tied together, all other devices will be on)	(V _{INB} - V _{OUTx}) > (V _{OCV} + V _{OCV_HY})	
	LED string short	V _{OUTx} < V _{SCV}	Faulty channel outputs I _{RTR} for recovery detection and other channels on			V _{OUTx} > (V _{SCV} + V _{SCV_HY})	
	Single LED short	V _{OUTx} < V _{SLSTH}	R _{FMODE} = 62kΩ	Faulty channel outputs I _{RTR} for recovery detection and other channels on		V _{OUTx} > (V _{SLSTH} + V _{SLSTH_HY})	
			R _{FMODE} = 150kΩ	All channels on			
	ISET open	ISET pin to GND resistance > R _{ISET_OC}	All channels off			ISET pin to GND resistance resumes to normal range	
	ISET short	ISET pin to GND resistance < R _{ISET_SC}	All channels off			ISET pin to GND resistance resumes to normal range	
	Thermal shutdown	T _J > T _{SD}	All channels off			T _J < (T _{SD} - T _{SDHY})	
	Thermal roll-off	T _J > T _{RO}	Output current of all channels linearly decreases toward zero following T _J increasing			High impedance (If the FAULTB pins of multiple devices are tied together, all other devices will be on)	T _J < T _{RO}

THERMAL CONSIDERATIONS

The package thermal resistance, θ_{JA} , determines the amount of heat that can pass from the silicon die to the surrounding ambient environment. The θ_{JA} is a measure of the temperature rise created by power dissipation and is usually measured in degree Celsius per watt (°C/W). The junction temperature, T_J , can be calculated by the rise of the silicon temperature, ΔT , the power dissipation on IS32LT3146, P_{3146} , and the

package thermal resistance, θ_{JA} , as in following equation:

$$T_J = T_A + \Delta T = T_A + P_{3146} \times \theta_{JA} \quad (20)$$

The P_{3146} is described in the “Thermal Shunt Mechanism” section.

When operating the chip at high ambient temperatures, or when the supply voltage is high, care must be taken to avoid exceeding the package

IS32LT3146

power dissipation limits. The maximum power dissipation at $T_A=25^{\circ}\text{C}$ can be calculated using the following equation:

$$P_{D(MAX)} = \frac{150^{\circ}\text{C} - 25^{\circ}\text{C}}{\theta_{JA}} \quad (21)$$

So,

$$P_{D(MAX)} = \frac{150^{\circ}\text{C} - 25^{\circ}\text{C}}{31.8^{\circ}\text{C}/\text{W}} \approx 3.93\text{W}$$

for eTSSOP-20 package.

Figure 50, shows the power derating of the IS32LT3146 on a JEDEC board (in accordance with JESD 51-5 and JESD 51-7) standing in still air.

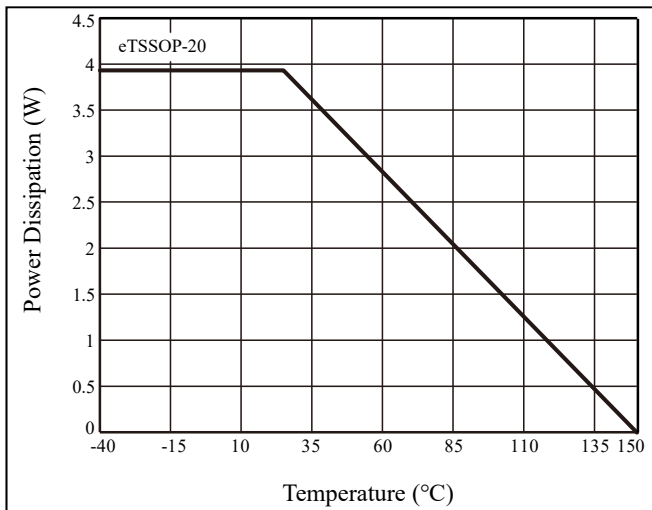

Figure 50 Dissipation Curve (eTSSOP-20)

In the thermal shunt application, the R_P will share quite a lot power dissipation; therefore its package power rating should be sufficient to prevent heat run away.

When designing the Printed Circuit Board (PCB) layout, double-sided PCB with a large copper area on each side of the board directly under the IS32LT3146 and the thermal shunt resistor. Multiple thermal vias, as shown in Figure 51, will help to conduct heat from the exposed pad of the IS32LT3146 and the thermal shunt resistor to the copper on each side of the board. To avoid the heat buildup, the thermal shunt resistor should be spread out on the PCB board with some distance from IS32LT3146.

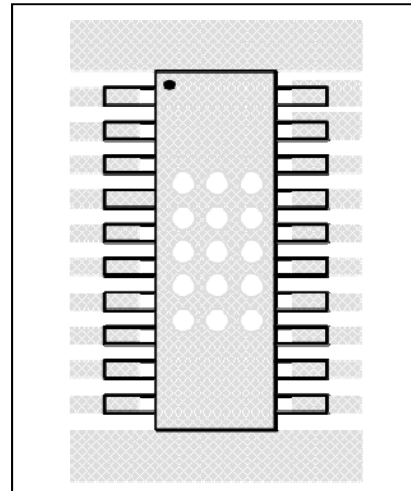

Figure 51 Board Via Layout For Thermal Dissipation

IS32LT3146

CLASSIFICATION REFLOW PROFILES

Profile Feature	Pb-Free Assembly
Preheat & Soak Temperature min (T _{smin}) Temperature max (T _{smax}) Time (T _{smin} to T _{smax}) (t _s)	150°C 200°C 60-120 seconds
Average ramp-up rate (T _{smax} to T _p)	3°C/second max.
Liquidous temperature (T _L) Time at liquidous (t _L)	217°C 60-150 seconds
Peak package body temperature (T _p)*	Max 260°C
Time (t _p)** within 5°C of the specified classification temperature (T _c)	Max 30 seconds
Average ramp-down rate (T _p to T _{smax})	6°C/second max.
Time 25°C to peak temperature	8 minutes max.

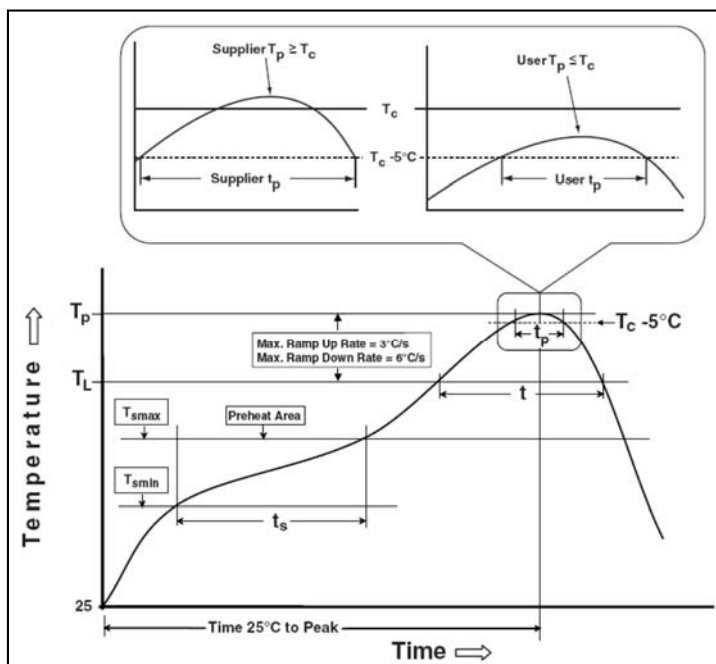
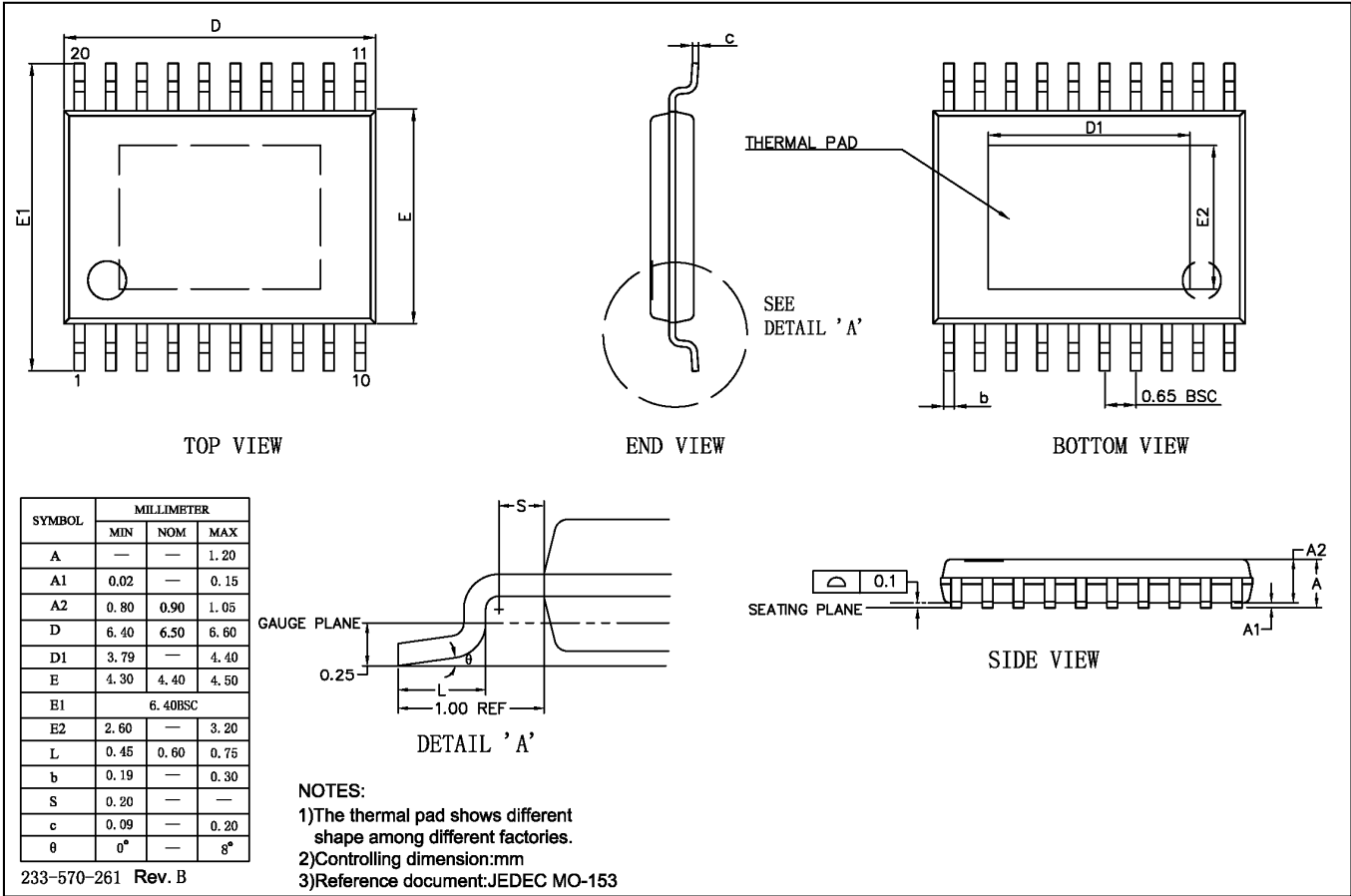

Figure 52 Classification Profile

IS32LT3146

PACKAGE INFORMATION

eTSSOP-20



IS32LT3146

RECOMMENDED LAND PATTERN

eTSSOP-20

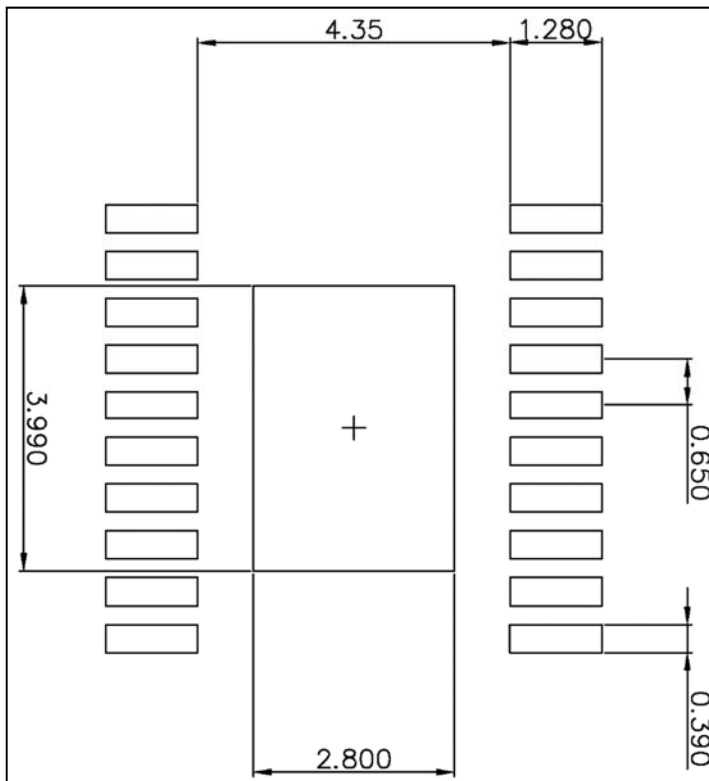

Note:

1. Land pattern complies to IPC-7351.
2. All dimensions in MM.
3. This document (including dimensions, notes & specs) is a recommendation based on typical circuit board manufacturing parameters. Since land pattern design depends on many factors unknown (eg. user's board manufacturing specs), user must determine suitability for use.

IS32LT3146

REVISION HISTORY

Revision	Detail Information	Date
A	Initial release	2022.03.03
B	Update figure 34, remove PWM1 pin	2022.06.09