

APPROVED BY: DATE: MFG. ENG. QA

ASS'Y P/N	CONTACT QTY.	CABLE O.D. RANGE
W18282-2PG-P-311	2	0.09 - 0.14 [2.3 - 3.6]
W18282-2PG-P-315	2	0.15 - 0.17 [3.8 - 4.3]
W18282-2PG-P-318	2	0.18 - 0.20 [4.6 - 5.1]
W18282-3PG-P-311	3	0.09 - 0.14 [2.3 - 3.6]
W18282-3PG-P-315	3	0.15 - 0.17 [3.8 - 4.3]
W18282-3PG-P-318	3	0.18 - 0.20 [4.6 - 5.1]
W18282-XPG-P-3XX		

NOTES:

1. ALL PARTS ARE BULK PACKED.
2. REFER TO DRAWING HPMCSTD FOR CONTACT PATTERNS.
3. ALL DIMENSIONS ARE REFERENCE ONLY IN INCHES [mm], WITHIN ±0.015 UNLESS OTHERWISE NOTED.

OF CONTACTS

GROMMET SIZE = CABLE O.D. RANGE:

- 311 = 0.09 - 0.14 [2.3 - 3.6]
- 315 = 0.15 - 0.17 [3.8 - 4.3]
- 318 = 0.18 - 0.20 [4.6 - 5.1]

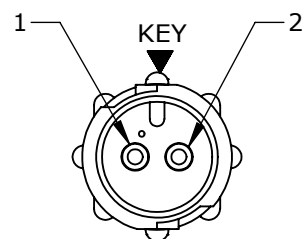

FACE VIEW
W18282-2PG-P-3XX

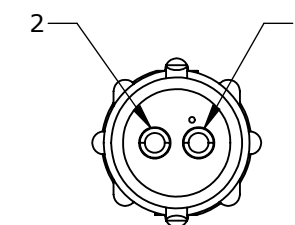
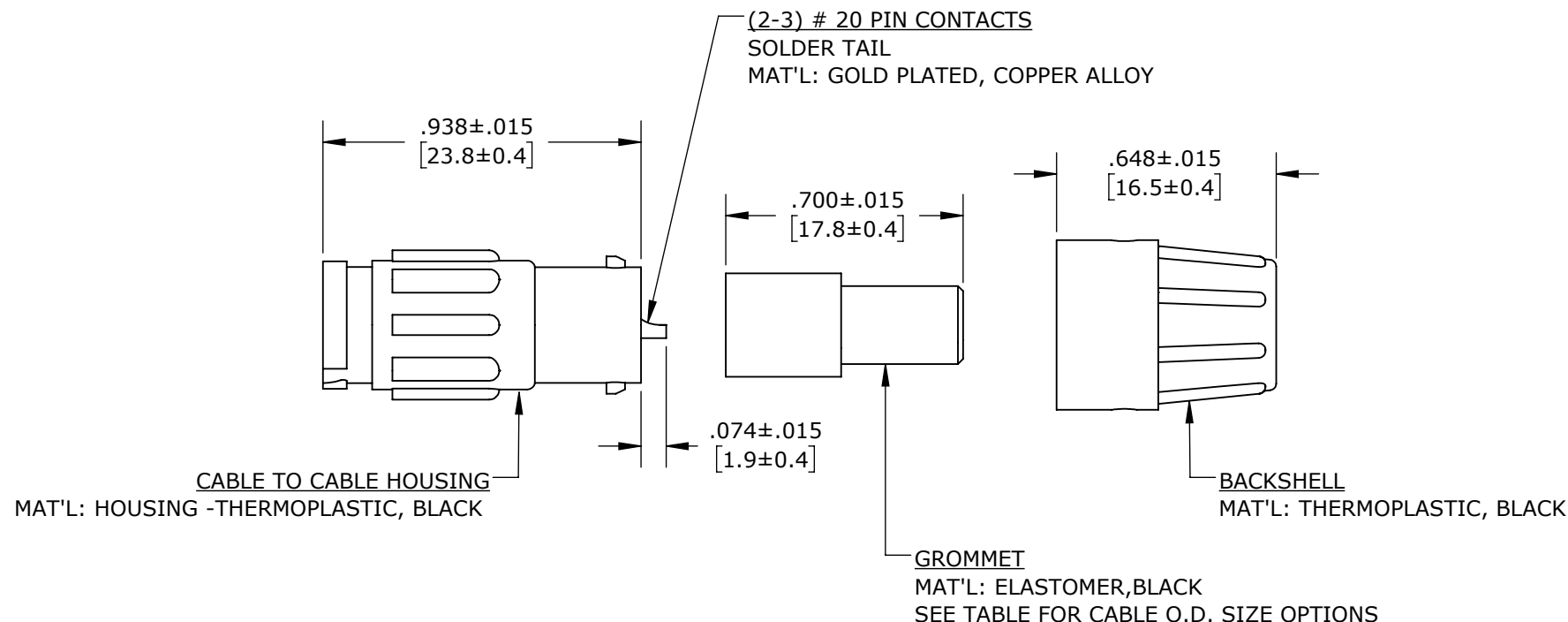

WIRING VIEW
W18282-2PG-P-3XX

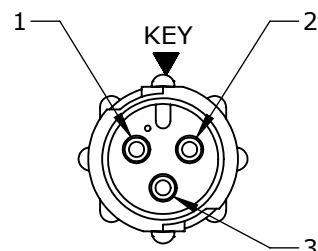

FACE VIEW
W18282-3PG-P-3XX

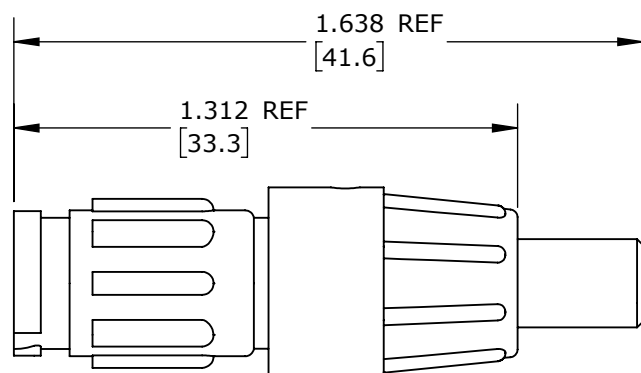

ASSEMBLED VIEW
FOR CUSTOMER REF. ONLY

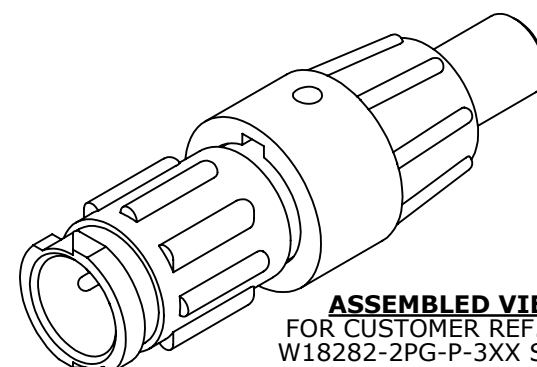

ASSEMBLED VIEW
FOR CUSTOMER REF. ONLY
W18282-2PG-P-3XX SHOWN

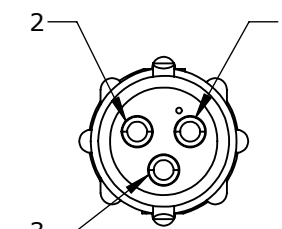

WIRING VIEW
W18282-3PG-P-3XX

CUSTOMER PRINT

PART NUMBER: W18282-XPG-P-3XX

CUSTOMER APPROVAL

THIS DOCUMENT CONTAINS CONFIDENTIAL INFORMATION PROPRIETARY TO CONXALL CORPORATION. ANY REPRODUCTION, DISCLOSURE, OR USE OF THIS DOCUMENT /INFORMATION IS EXPRESSLY PROHIBITED UNLESS AUTHORIZED IN WRITING BY CONXALL CORPORATION.

APPROVED BY: _____
DATE: _____

RoHS COMPLIANT

DIMENSIONS IS BRACKETS [] ARE METRIC

PRELIMINARY

0A	JGK	8/22/19	DRAWING CREATED FOR PDR #18004.	
REV.	INIT.	DATE	DESCRIPTION	
			ORIG. DRAWN BY: JGK	DATE: 8/22/19
ALL INFORMATION ILLUSTRATED IS THE PROPERTY OF "CONXALL CORPORATION." UNAUTHORIZED DUPLICATION OR DISTRIBUTION OF THIS DOCUMENT IS PROHIBITED.			<p>601 E. WILDWOOD VILLA PARK, IL 60181</p>	
ALL UNITS ARE IN FEET, INCHES, FRACTION OF INCHES AND DECIMALS. UNLESS OTHERWISE SPECIFIED TOLERANCES: 3 PLACE DECIMALS ±.005 ANGLES ±1° FRACTIONS ±1/16				
APPROVED BY: _____			TITLE: CABLE TO CABLE CONN. ASS'Y (2-3) #20 PIN CONTACTS, SOLDER INSTA-CLICK, MICRO-CON-X STANDARD PRODUCT	
SCALE	SIZE	SHEET	CUSTOMER: _____	
NTS	B	1 OF 1	PART NUMBER: W18282-XPG-P-3XX	
FILE: W18282-XPG-P-3XX	DIRECTORY: SLW		REV 0A	