

## NDS9945-NL-VB Datasheet

### Dual N-Channel 60 V (D-S) 175 °C MOSFET

PRODUCT SUMMARY	
V <sub>DS</sub> (V)	60
R <sub>DS(on)</sub> (Ω) at V <sub>GS</sub> = 10 V	0.028
R <sub>DS(on)</sub> (Ω) at V <sub>GS</sub> = 4.5 V	0.030
I <sub>D</sub> (A) per leg	7
Configuration	Dual

#### FEATURES

- TrenchFET® power MOSFET
- 100 % R<sub>G</sub> and UIS tested



**RoHS**  
COMPLIANT  
HALOGEN  
**FREE**

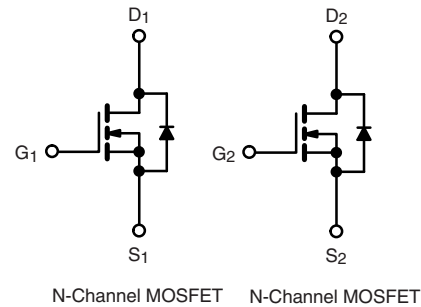
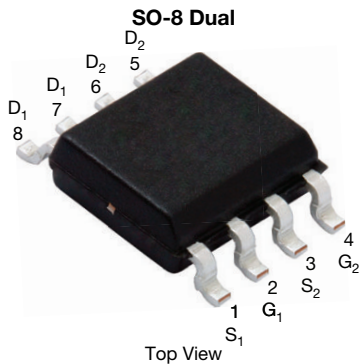

ABSOLUTE MAXIMUM RATINGS (T <sub>C</sub> = 25 °C, unless otherwise noted)			
PARAMETER	SYMBOL	LIMIT	UNIT
Drain-Source Voltage	V <sub>DS</sub>	60	V
Gate-Source Voltage	V <sub>GS</sub>	± 20	
Continuous Drain Current	I <sub>D</sub>	T <sub>C</sub> = 25 °C	7
		T <sub>C</sub> = 125 °C	4
Continuous Source Current (Diode Conduction) <sup>a</sup>	I <sub>S</sub>	3.6	A
Pulsed Drain Current <sup>b</sup>	I <sub>DM</sub>	28	
Single Pulse Avalanche Current	I <sub>AS</sub>	18	
Single Pulse Avalanche Energy	E <sub>AS</sub>	16.2	mJ
Maximum Power Dissipation <sup>b</sup>	P <sub>D</sub>	T <sub>C</sub> = 25 °C	4
		T <sub>C</sub> = 125 °C	1.3
Operating Junction and Storage Temperature Range	T <sub>J</sub> , T <sub>stg</sub>	-55 to +175	°C

THERMAL RESISTANCE RATINGS			
PARAMETER	SYMBOL	LIMIT	UNIT
Junction-to-Ambient	R <sub>thJA</sub>	110	°C/W
Junction-to-Foot (Drain)	R <sub>thJF</sub>	34	

#### Notes

- Package limited.
- Pulse test; pulse width ≤ 300 μs, duty cycle ≤ 2 %.
- When mounted on 1" square PCB (FR4 material).

SPECIFICATIONS (T <sub>C</sub> = 25 °C, unless otherwise noted)							
PARAMETER	SYMBOL	TEST CONDITIONS		MIN.	TYP.	MAX.	UNIT
<b>Static</b>							
Drain-Source Breakdown Voltage	V <sub>DS</sub>	V <sub>GS</sub> = 0 V, I <sub>D</sub> = 250 μA		60	-	-	V
Gate-Source Threshold Voltage	V <sub>GS(th)</sub>	V <sub>DS</sub> = V <sub>GS</sub> , I <sub>D</sub> = 250 μA		1.5	2.0	2.5	
Gate-Source Leakage	I <sub>GSS</sub>	V <sub>DS</sub> = 0 V, V <sub>GS</sub> = ± 20 V		-	-	± 100	nA
Zero Gate Voltage Drain Current	I <sub>DSS</sub>	V <sub>GS</sub> = 0 V	V <sub>DS</sub> = 60 V	-	-	1	μA
		V <sub>GS</sub> = 0 V	V <sub>DS</sub> = 60 V, T <sub>J</sub> = 125 °C	-	-	50	
		V <sub>GS</sub> = 0 V	V <sub>DS</sub> = 60 V, T <sub>J</sub> = 175 °C	-	-	150	
On-State Drain Current <sup>a</sup>	I <sub>D(on)</sub>	V <sub>GS</sub> = 10 V	V <sub>DS</sub> ≥ 5 V	20	-	-	A
Drain-Source On-State Resistance <sup>a</sup>	R <sub>DS(on)</sub>	V <sub>GS</sub> = 10 V	I <sub>D</sub> = 4.5 A-	-	0.028	-	Ω
		V <sub>GS</sub> = 10 V	I <sub>D</sub> = 4.5 A, T <sub>J</sub> = 125 °C	-	0.066	-	
		V <sub>GS</sub> = 10 V	I <sub>D</sub> = 4.5 A, T <sub>J</sub> = 175 °C	-	0.081	-	
		V <sub>GS</sub> = 4.5 V	I <sub>D</sub> = 4 A-	-	0.030	-	
Forward Transconductance <sup>f</sup>	g <sub>fs</sub>	V <sub>DS</sub> = 15 V, I <sub>D</sub> = 4.5 A		-	15	-	S
<b>Dynamic <sup>b</sup></b>							
Input Capacitance	C <sub>iss</sub>	V <sub>GS</sub> = 0 V	V <sub>DS</sub> = 25 V, f = 1 MHz	-	600	750	pF
Output Capacitance	C <sub>oss</sub>			-	110	140	
Reverse Transfer Capacitance	C <sub>rss</sub>			-	50	62	
Total Gate Charge <sup>c</sup>	Q <sub>g</sub>	V <sub>GS</sub> = 10 V	V <sub>DS</sub> = 30 V, I <sub>D</sub> = 5.3 A	-	11.7	18	nC
Gate-Source Charge <sup>c</sup>	Q <sub>gs</sub>			-	1.8	2.7	
Gate-Drain Charge <sup>c</sup>	Q <sub>gd</sub>			-	2.8	4.2	
Gate Resistance	R <sub>g</sub>	f = 1 MHz		1.3	-	6	Ω
Turn-On Delay Time <sup>c</sup>	t <sub>d(on)</sub>	V <sub>DD</sub> = 30 V, R <sub>L</sub> = 6.8 Ω I <sub>D</sub> ≅ 4.4 A, V <sub>GEN</sub> = 10 V, R <sub>g</sub> = 1 Ω		-	7	11	ns
Rise Time <sup>c</sup>	t <sub>r</sub>			-	3.3	5	
Turn-Off Delay Time <sup>c</sup>	t <sub>d(off)</sub>			-	22.4	33.5	
Fall Time <sup>c</sup>	t <sub>f</sub>			-	2.1	3.2	
<b>Source-Drain Diode Ratings and Characteristics <sup>b</sup></b>							
Pulsed Current <sup>a</sup>	I <sub>SM</sub>			-	-	28	A
Forward Voltage	V <sub>SD</sub>	I <sub>F</sub> = 2 A, V <sub>GS</sub> = 0 V		-	0.75	1.1	V

**Notes**

- a. Pulse test; pulse width ≤ 300 μs, duty cycle ≤ 2 %.
- b. Guaranteed by design, not subject to production testing.
- c. Independent of operating temperature.

**TYPICAL CHARACTERISTICS** ( $T_A = 25\text{ }^\circ\text{C}$ , unless otherwise noted)

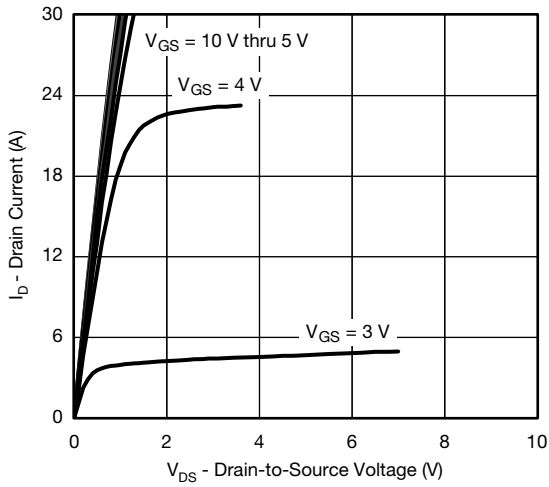

**Output Characteristics**

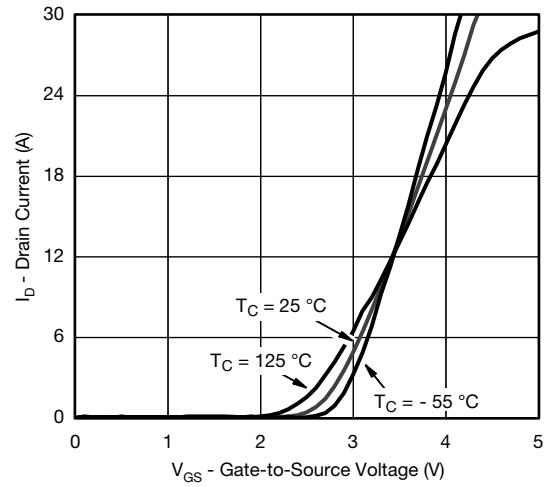

**Transfer Characteristics**

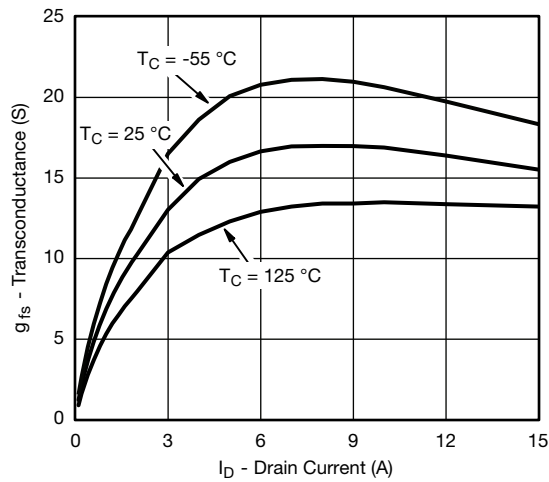

**Transconductance**

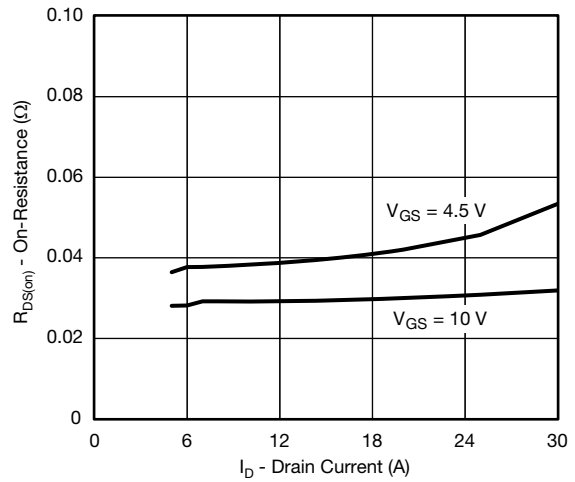

**On-Resistance vs. Drain Current**

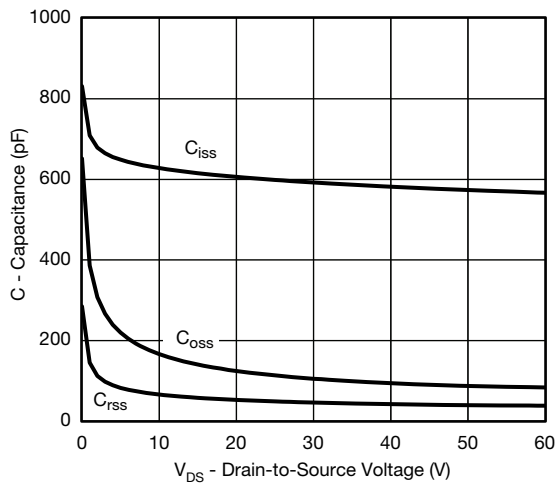

**Capacitance**



**Gate Charge**

**TYPICAL CHARACTERISTICS** ( $T_A = 25\text{ }^\circ\text{C}$ , unless otherwise noted)



**On-Resistance vs. Junction Temperature**



**Drain Source Breakdown vs. Junction Temperature**



**Source Drain Diode Forward Voltage**



**On-Resistance vs. Gate-to-Source Voltage**



**Threshold Voltage**

**THERMAL RATINGS** ( $T_A = 25\text{ }^\circ\text{C}$ , unless otherwise noted)

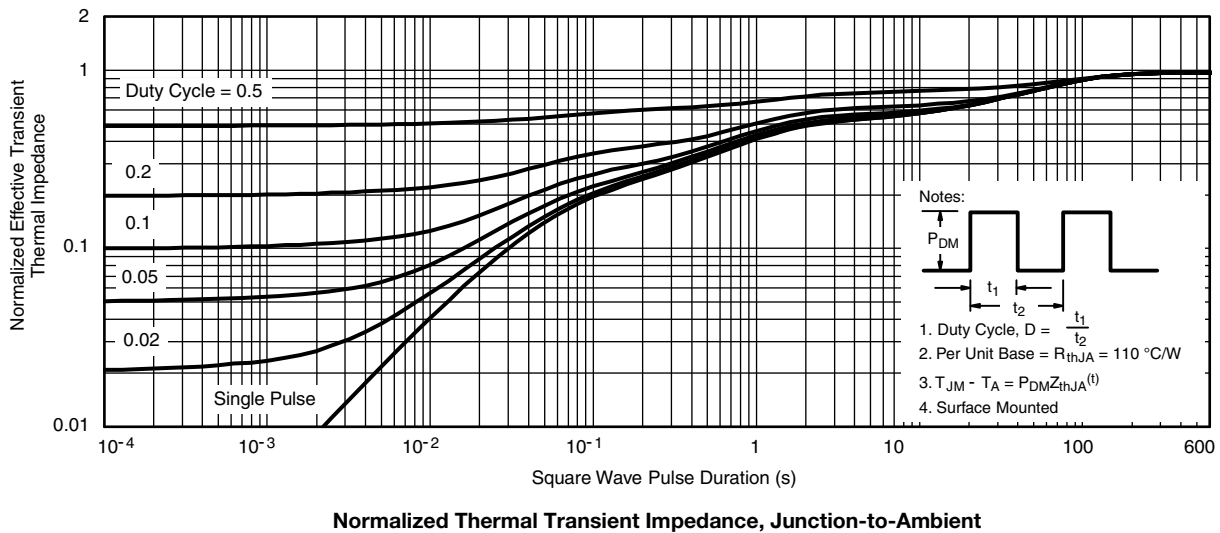

**THERMAL RATINGS** ( $T_A = 25\text{ }^\circ\text{C}$ , unless otherwise noted)

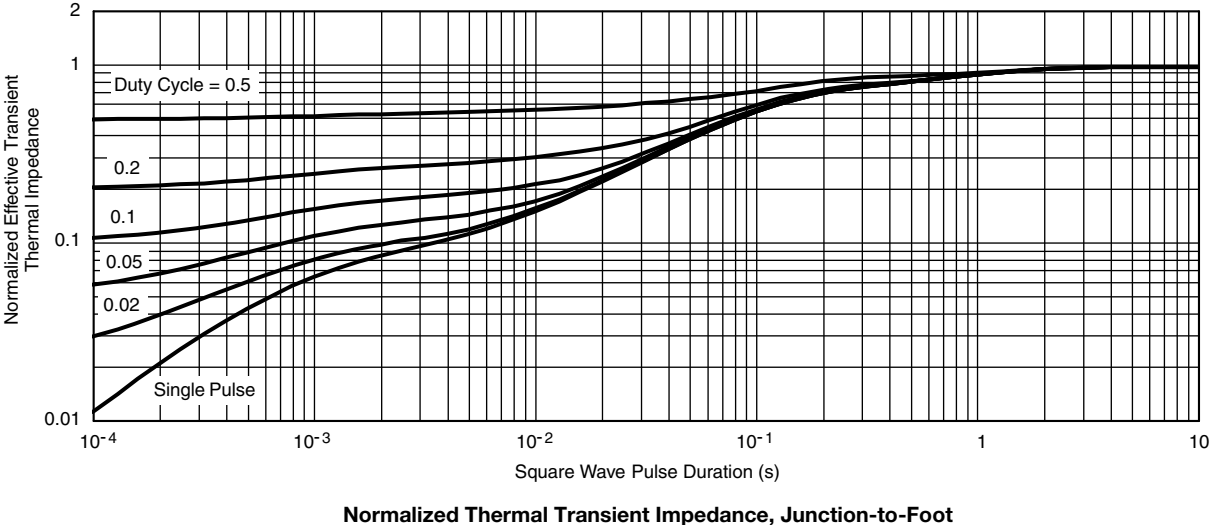

**SOIC (NARROW): 8-LEAD**  
JEDEC Part Number: MS-012



DIM	MILLIMETERS		INCHES	
	Min	Max	Min	Max
A	1.35	1.75	0.053	0.069
A <sub>1</sub>	0.10	0.20	0.004	0.008
B	0.35	0.51	0.014	0.020
C	0.19	0.25	0.0075	0.010
D	4.80	5.00	0.189	0.196
E	3.80	4.00	0.150	0.157
e	1.27 BSC		0.050 BSC	
H	5.80	6.20	0.228	0.244
h	0.25	0.50	0.010	0.020
L	0.50	0.93	0.020	0.037
q	0°	8°	0°	8°
S	0.44	0.64	0.018	0.026
ECN: C-06527-Rev. I, 11-Sep-06 DWG: 5498				

RECOMMENDED MINIMUM PADS FOR SO-8

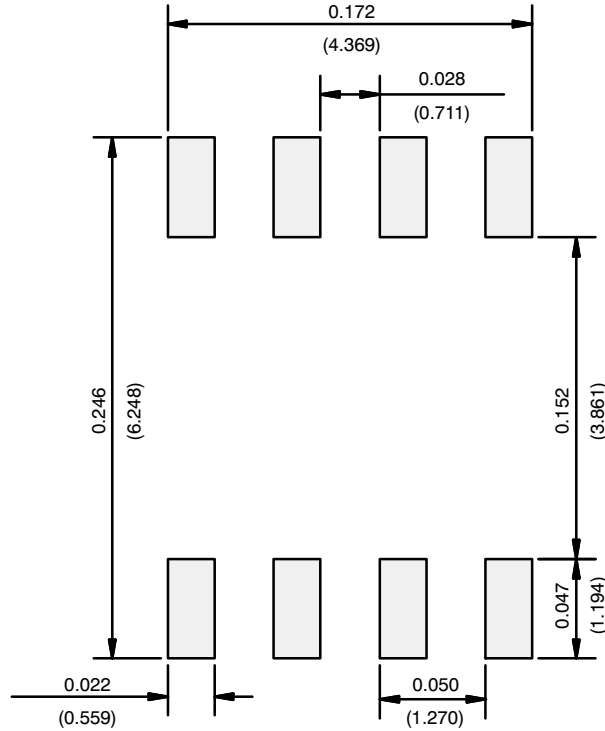

Recommended Minimum Pads  
Dimensions in Inches/(mm)



# Disclaimer

All products due to improve reliability, function or design or for other reasons, product specifications and data are subject to change without notice.

Taiwan VBsemi Electronics Co., Ltd., branches, agents, employees, and all persons acting on its or their representatives (collectively, the "Taiwan VBsemi"), assumes no responsibility for any errors, inaccuracies or incomplete data contained in the table or any other any disclosure of any information related to the product.(www.VBsemi.com)

Taiwan VBsemi makes no guarantee, representation or warranty on the product for any particular purpose of any goods or continuous production. To the maximum extent permitted by applicable law on Taiwan VBsemi relinquished: (1) any application and all liability arising out of or use of any products; (2) any and all liability, including but not limited to special, consequential damages or incidental ; (3) any and all implied warranties, including a particular purpose, non-infringement and merchantability guarantee.

Statement on certain types of applications are based on knowledge of the product is often used in a typical application of the general product VBsemi Taiwan demand that the Taiwan VBsemi of. Statement on whether the product is suitable for a particular application is non-binding. It is the customer's responsibility to verify specific product features in the products described in the specification is appropriate for use in a particular application. Parameter data sheets and technical specifications can be provided may vary depending on the application and performance over time. All operating parameters, including typical parameters must be made by customer's technical experts validated for each customer application. Product specifications do not expand or modify Taiwan VBsemi purchasing terms and conditions, including but not limited to warranty herein.

Unless expressly stated in writing, Taiwan VBsemi products are not intended for use in medical, life saving, or life sustaining applications or any other application. Wherein VBsemi product failure could lead to personal injury or death, use or sale of products used in Taiwan VBsemi such applications using client did not express their own risk. Contact your authorized Taiwan VBsemi people who are related to product design applications and other terms and conditions in writing.

The information provided in this document and the company's products without a license, express or implied, by estoppel or otherwise, to any intellectual property rights granted to the VBsemi act or document. Product names and trademarks referred to herein are trademarks of their respective representatives will be all.

## Material Category Policy

**Taiwan VBsemi Electronics Co., Ltd., hereby certify that all of the products are determined to be RoHS compliant and meets the definition of restrictions under Directive of the European Parliament 2011/65 / EU, 2011 Nian. 6. 8 Ri Yue restrict the use of certain hazardous substances in electrical and electronic equipment (EEE) - modification, unless otherwise specified as inconsistent.(www.VBsemi.com)**

**Please note that some documents may still refer to Taiwan VBsemi RoHS Directive 2002/95 / EC. We confirm that all products identified as consistent with the Directive 2002/95 / EC European Directive 2011/65 / .**

**Taiwan VBsemi Electronics Co., Ltd. hereby certify that all of its products comply identified as halogen-free halogen-free standards required by the JEDEC JS709A. Please note that some Taiwanese VBsemi documents still refer to the definition of IEC 61249-2-21, and we are sure that all products conform to confirm compliance with IEC 61249-2-21 standard level JS709A.**