

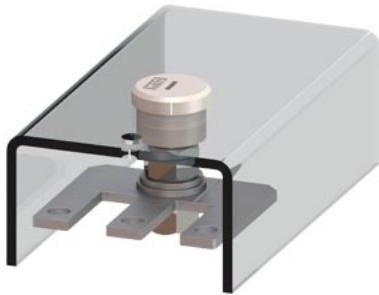



Link for paralleling With connecting terminal, 3-pole for 3RT2.4





General technical data		
product brand name		SIRIUS
product designation		Infeed terminal
design of the product		Parallel switching connection for contactors S3

Certificates/ approvals

General Product Approval	Declaration of Conformity	Test Certificates
		Miscellaneous
		Special Test Certificate
		Type Test Certificates/Test Report

Shipping Approval

Shipping Approval	other
	Confirmation
	Miscellaneous
	

Further information

- Information- and Downloadcenter (Catalogs, Brochures,...)
<https://www.siemens.com/ic10>
- Industry Mall (Online ordering system)
<https://mall.industry.siemens.com/mall/en/en/Catalog/product?mlfb=3RT1946-4BB31>
- Cax online generator
<http://support.automation.siemens.com/WW/CAXorder/default.aspx?lang=en&mlfb=3RT1946-4BB31>
- Service&Support (Manuals, Certificates, Characteristics, FAQs,...)
<https://support.industry.siemens.com/cs/ww/en/ps/3RT1946-4BB31>
- Image database (product images, 2D dimension drawings, 3D models, device circuit diagrams, EPLAN macros, ...)
http://www.automation.siemens.com/bilddb/cax_de.aspx?mlfb=3RT1946-4BB31&lang=en

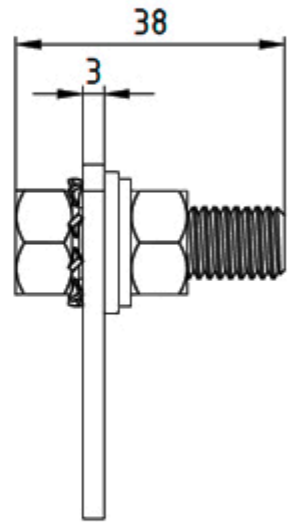
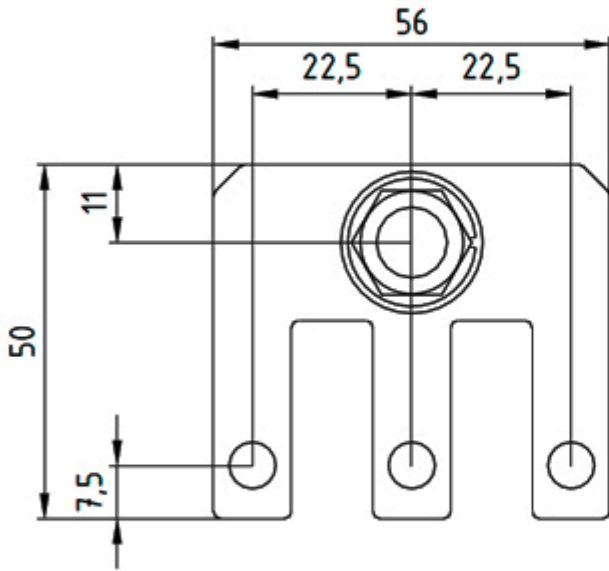

last modified:

12/2/2020 