

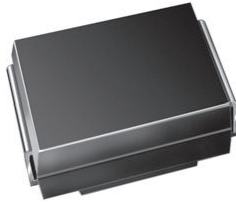

## Surface-Mount TRANSZORB® Transient Voltage Suppressors



SMB (DO-214AA)

### LINKS TO ADDITIONAL RESOURCES



PRIMARY CHARACTERISTICS	
V <sub>BR</sub> (unidirectional)	6.5 V to 228 V
V <sub>BR</sub> (bidirectional)	6.5 V to 145 V
V <sub>WM</sub> (unidirectional)	5.0 V to 188 V
V <sub>WM</sub> (bidirectional)	5.0 V to 120 V
P <sub>PPM</sub>	600 W
P <sub>D</sub> at T <sub>M</sub> = 50 °C	5.0 W
P <sub>D</sub> at T <sub>A</sub> = 25 °C	1.0 W
T <sub>J</sub> max.	150 °C
Polarity	Unidirectional, bidirectional
Package	SMB (DO-214AA)

### DEVICES FOR BIDIRECTIONAL APPLICATIONS

For bidirectional devices use CD suffix (e.g. SMBJ5.0CD). Electrical characteristics apply in both directions.

### FEATURES

- Low profile package
- Ideal for automated placement
- ± 3.5 %: very tight V<sub>BR</sub> tolerance
- Low leakage current
- Available in unidirectional and bidirectional
- 600 W peak pulse power capability with a 10/1000 μs waveform, repetitive rate (duty cycle): 0.01 %
- Excellent clamping capability
- Very fast response time
- Low incremental surge resistance
- Meets MSL level 1, per J-STD-020, LF maximum peak of 260 °C
- Material categorization: for definitions of compliance please see [www.vishay.com/doc?99912](http://www.vishay.com/doc?99912)



RoHS COMPLIANT HALOGEN FREE

### TYPICAL APPLICATIONS

Use in sensitive electronics protection against voltage transients induced by inductive load switching and lighting on ICs, MOSFETs, signal lines of sensor units for consumer, computer, industrial, and telecommunication.

### MECHANICAL DATA

**Case:** SMB (DO-214AA)

Molding compound meets UL 94 V-0 flammability rating  
Base P/N-M3 - halogen-free, RoHS-compliant, and industrial grade

**Terminals:** matte tin plated leads, solderable per J-STD-002 and JESD 22-B102

M3 suffix meets JESD 201 class 2 whisker test

**Polarity:** for unidirectional types the band denotes cathode end, no cathode band on bidirectional types

MAXIMUM RATINGS (T <sub>A</sub> = 25 °C unless otherwise noted)				
PARAMETER		SYMBOL	VALUE	UNIT
Peak pulse power dissipation	with a 10/1000 μs waveform	P <sub>PPM</sub> <sup>(1)</sup>	600	W
Peak pulse current	with a 10/1000 μs waveform	I <sub>PPM</sub> <sup>(1)</sup>	See next table	A
Power dissipation	T <sub>M</sub> = 50 °C	P <sub>D</sub> <sup>(2)</sup>	5.0	W
	T <sub>A</sub> = 25 °C	P <sub>D</sub> <sup>(3)</sup>	1.0	
Operating junction and storage temperature range		T <sub>J</sub> , T <sub>STG</sub>	-55 to +150	°C

### Notes

- (1) Non-repetitive current pulse, per fig. 3 and derated above T<sub>A</sub> = 25 °C per fig. 2
- (2) Power dissipation mounted on infinite heatsink
- (3) Power dissipation mounted on minimum recommended pad layout



ELECTRICAL CHARACTERISTICS (T <sub>A</sub> = 25 °C unless otherwise noted)									
DEVICE TYPE	DEVICE MARKING CODE		BREAKDOWN VOLTAGE V <sub>BR</sub> AT I <sub>T</sub> (1)		TEST CURRENT I <sub>T</sub> (mA)	STAND-OFF VOLTAGE V <sub>WM</sub> (V)	MAXIMUM REVERSE LEAKAGE AT V <sub>WM</sub> I <sub>D</sub> (μA) (2)	MAXIMUM PEAK PULSE SURGE CURRENT I <sub>PPM</sub> (A) (3)	MAXIMUM CLAMPING VOLTAGE AT I <sub>PPM</sub> V <sub>C</sub> (V)
	UNI	BI	MIN.	MAX.					
(+)SMBJ5.0D	6AA	6AA	6.50	6.97	10	5.0	500	65.9	9.1
(+)SMBJ6.0D	6AB	6AB	6.77	7.27	10	6.0	500	58.9	10.2
(+)SMBJ6.5D	6AC	6AC	7.33	7.87	10	6.5	300	54.5	11.0
(+)SMBJ7.0D	6AD	6AD	7.90	8.48	10	7.0	150	50.8	11.8
(+)SMBJ7.5D	6AE	6AE	8.46	9.08	1.0	7.5	75	47.2	12.7
(+)SMBJ8.0D	6AF	6AF	9.03	9.69	1.0	8.0	35	44.8	13.4
(+)SMBJ8.5D	6AG	6AG	9.57	10.3	1.0	8.5	15	42.2	14.3
(+)SMBJ9.0D	6AH	6AH	10.2	10.9	1.0	9.0	5.0	39.7	15.1
(+)SMBJ10D	6AK	6AK	11.3	12.1	1.0	10	2.0	35.9	16.7
(+)SMBJ11D	6AL	6AL	12.4	13.3	1.0	11	2.0	33.5	17.9
(+)SMBJ12D	6AM	6AM	13.5	14.5	1.0	12	2.0	30.6	19.6
(+)SMBJ13D	6AN	6AN	14.6	15.7	1.0	13	0.5	28.3	21.2
(+)SMBJ14D	6AP	6AP	15.8	17.0	1.0	14	0.5	26.2	22.9
(+)SMBJ15D	6AQ	6AQ	17.0	18.2	1.0	15	0.5	25.0	24.0
(+)SMBJ16D	6AR	6AR	18.1	19.4	1.0	16	0.5	23.4	25.6
(+)SMBJ17D	6AS	6AS	19.2	20.6	1.0	17	0.5	22.1	27.2
(+)SMBJ18D	6AT	6AT	20.3	21.8	1.0	18	0.5	20.8	28.8
(+)SMBJ20D	6AU	6AU	22.5	24.2	1.0	20	0.5	18.8	32.0
(+)SMBJ22D	6AV	6AV	24.8	26.6	1.0	22	0.5	17.1	35.1
(+)SMBJ24D	6AW	6AW	27.1	29.1	1.0	24	0.5	15.6	38.4
(+)SMBJ26D	6AX	6AX	29.3	31.5	1.0	26	0.5	14.5	41.6
(+)SMBJ28D	6AY	6AY	31.6	33.9	1.0	28	0.5	13.4	44.7
(+)SMBJ30D	6AZ	6AZ	33.8	36.3	1.0	30	0.5	12.6	47.7
(+)SMBJ33D	6BA	6BA	37.3	40.0	1.0	33	0.5	11.5	52.5
(+)SMBJ36D	6BB	6BB	40.6	43.6	1.0	36	0.5	10.5	57.3
(+)SMBJ40D	6BC	6BC	45.1	48.4	1.0	40	0.5	9.43	63.6
(+)SMBJ43D	6BD	6BD	48.5	52.1	1.0	43	0.5	8.76	68.5
(+)SMBJ45D	6BE	6BE	50.8	54.5	1.0	45	0.5	8.40	71.6
(+)SMBJ48D	6BF	6BF	54.1	58.1	1.0	48	0.5	7.90	76.3
(+)SMBJ51D	6BG	6BG	57.6	61.8	1.0	51	0.5	7.40	81.2
(+)SMBJ54D	6BH	6BH	60.9	65.4	1.0	54	0.5	7.00	85.9
(+)SMBJ58D	6BK	6BK	65.4	70.2	1.0	58	0.5	6.50	92.3
(+)SMBJ60D	6BL	6BL	67.7	72.7	1.0	60	0.5	6.28	95.5
(+)SMBJ64D	6BM	6BM	72.2	77.5	1.0	64	0.5	5.88	102
(+)SMBJ70D	6BN	6BN	79.0	84.8	1.0	70	0.5	5.40	111
(+)SMBJ75D	6BP	6BP	84.6	90.8	1.0	75	0.5	5.06	119
(+)SMBJ78D	6BQ	6BQ	88.1	94.4	1.0	78	0.5	4.86	124
(+)SMBJ85D	6BR	6BR	95.7	103	1.0	85	0.5	4.46	135
(+)SMBJ90D	6BS	6BS	102	109	1.0	90	0.5	4.17	144
(+)SMBJ100D	6BT	6BT	113	121	1.0	100	0.5	3.77	159
(+)SMBJ110D	6BU	6BU	124	133	1.0	110	0.5	3.45	174
(+)SMBJ120D	6BV	6BV	135	145	1.0	120	0.5	3.15	190
(+)SMBJ130D	6BW	-	146	157	1.0	130	0.5	2.94	206
(+)SMBJ150D	6BX	-	170	182	1.0	150	0.5	2.53	239
(+)SMBJ160D	6BY	-	181	194	1.0	160	0.5	2.34	256
(+)SMBJ170D	6BZ	-	192	206	1.0	170	0.5	2.23	270
SMBJ188D	6CA	-	212	228	1.0	188	0.5	2.03	301

**Notes**

- All terms and symbols are consistent with ANSI/IEEE C62.35
- (1) Pulse test: t<sub>p</sub> ≤ 50 ms
- (2) For bi-directional types having V<sub>WM</sub> of 12 V and less, the I<sub>D</sub> limit is doubled
- (3) Surge current waveform per fig. 3 and derate per fig. 2
- (+) Underwriters Laboratory Recognition for the classification of protectors (QVGQ2) under the UL standard for safety 497B and file number E136766 for both uni-directional and bi-directional device



THERMAL CHARACTERISTICS (T <sub>A</sub> = 25 °C unless otherwise noted)			
PARAMETER	SYMBOL	VALUE	UNIT
Typical thermal resistance, junction to ambient	R <sub>θJA</sub> (1)	125	°C/W
	R <sub>θJA</sub> (2)	100	
Typical thermal resistance, junction to mount	R <sub>θJM</sub>	20	

Notes

- (1) Mounted on minimum recommended pad layout
- (2) Mounted on 5.0 mm x 5.0 mm copper pad area

ORDERING INFORMATION (Example)				
PREFERRED P/N	UNIT WEIGHT (g)	PREFERRED PACKAGE CODE	BASE QUANTITY	DELIVERY MODE
SMBJ5.0D-M3/H	0.096	H	750	7" diameter plastic tape and reel
SMBJ5.0D-M3/I	0.096	I	3200	13" diameter plastic tape and reel

RATINGS AND CHARACTERISTICS CURVES (T<sub>A</sub> = 25 °C unless otherwise noted)

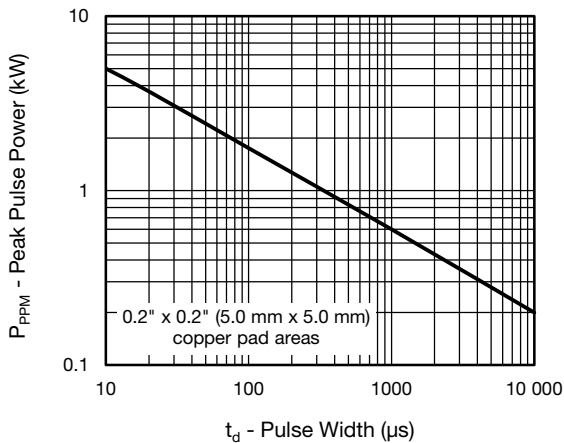

Fig. 1 - Peak Pulse Power Rating Curve

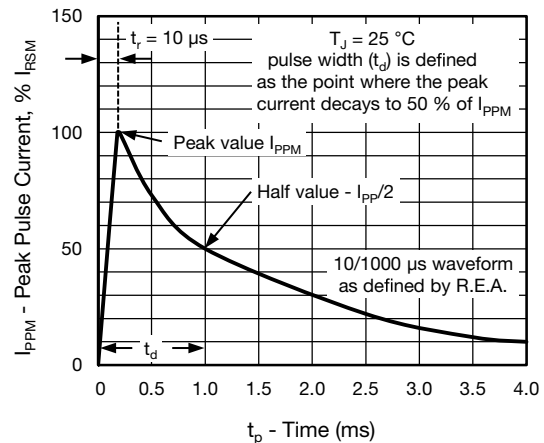

Fig. 3 - Pulse Waveform

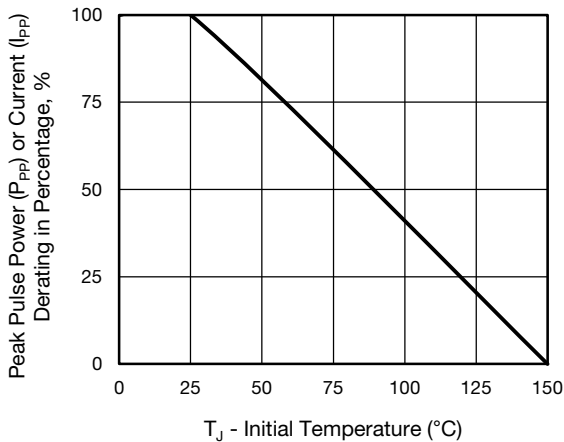

Fig. 2 - Pulse Power or Current vs. Initial Junction Temperature

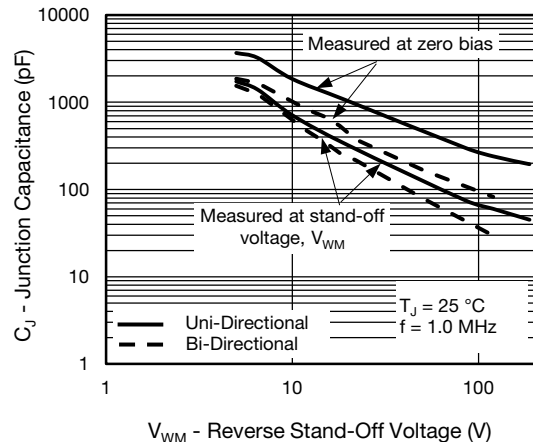

Fig. 4 - Typical Junction Capacitance

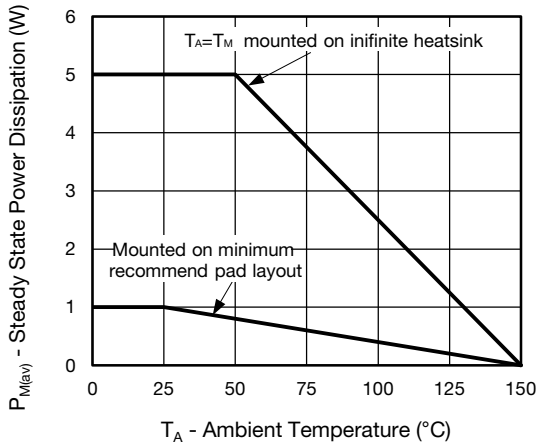

Fig. 5 - Power Dissipation Derating Curve

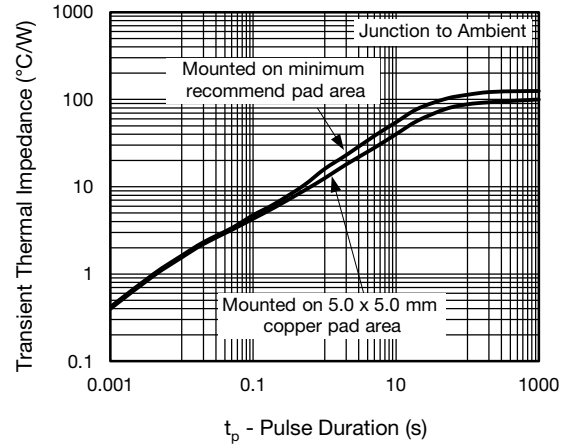
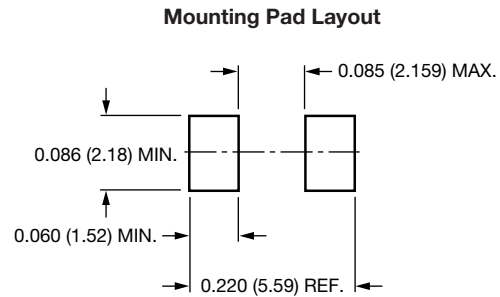
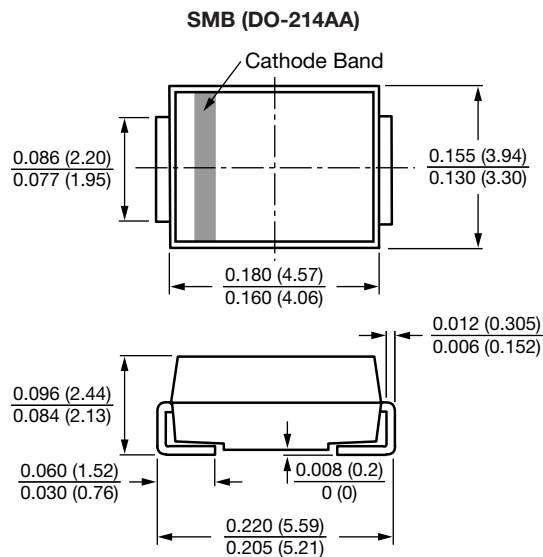

Fig. 6 - Typical Transient Thermal Impedance

**Note**

- Fig.1, 10 000  $\mu$ s  $P_{ppm}$  is actual test for  $V_{WM} \leq 60$  V types, over 60 V types 10 000  $\mu$ s  $P_{ppm}$  is curve extensional value

**PACKAGE OUTLINE DIMENSIONS** in inches (millimeters)





## Disclaimer

ALL PRODUCT, PRODUCT SPECIFICATIONS AND DATA ARE SUBJECT TO CHANGE WITHOUT NOTICE TO IMPROVE RELIABILITY, FUNCTION OR DESIGN OR OTHERWISE.

Vishay Intertechnology, Inc., its affiliates, agents, and employees, and all persons acting on its or their behalf (collectively, "Vishay"), disclaim any and all liability for any errors, inaccuracies or incompleteness contained in any datasheet or in any other disclosure relating to any product.

Vishay makes no warranty, representation or guarantee regarding the suitability of the products for any particular purpose or the continuing production of any product. To the maximum extent permitted by applicable law, Vishay disclaims (i) any and all liability arising out of the application or use of any product, (ii) any and all liability, including without limitation special, consequential or incidental damages, and (iii) any and all implied warranties, including warranties of fitness for particular purpose, non-infringement and merchantability.

Statements regarding the suitability of products for certain types of applications are based on Vishay's knowledge of typical requirements that are often placed on Vishay products in generic applications. Such statements are not binding statements about the suitability of products for a particular application. It is the customer's responsibility to validate that a particular product with the properties described in the product specification is suitable for use in a particular application. Parameters provided in datasheets and / or specifications may vary in different applications and performance may vary over time. All operating parameters, including typical parameters, must be validated for each customer application by the customer's technical experts. Product specifications do not expand or otherwise modify Vishay's terms and conditions of purchase, including but not limited to the warranty expressed therein.

Hyperlinks included in this datasheet may direct users to third-party websites. These links are provided as a convenience and for informational purposes only. Inclusion of these hyperlinks does not constitute an endorsement or an approval by Vishay of any of the products, services or opinions of the corporation, organization or individual associated with the third-party website. Vishay disclaims any and all liability and bears no responsibility for the accuracy, legality or content of the third-party website or for that of subsequent links.

Except as expressly indicated in writing, Vishay products are not designed for use in medical, life-saving, or life-sustaining applications or for any other application in which the failure of the Vishay product could result in personal injury or death. Customers using or selling Vishay products not expressly indicated for use in such applications do so at their own risk. Please contact authorized Vishay personnel to obtain written terms and conditions regarding products designed for such applications.

No license, express or implied, by estoppel or otherwise, to any intellectual property rights is granted by this document or by any conduct of Vishay. Product names and markings noted herein may be trademarks of their respective owners.