

PXD10-xxWDxx Dual Output DC/DC Converter

9 to 36 Vdc and 18 to 75 Vdc input, ± 5 to ± 15 Vdc Dual Output, 10W



Features

- Dual output up to $\pm 1000\text{mA}$
- 10 watts maximum output power
- 4:1 ultra wide input voltage range of 9-36 and 18-75VDC
- Six-sided continuous shield
- High efficiency up to 82%
- Low profile: 2.00×1.00×0.40 inch (50.8×25.4×10.2 mm)
- Fixed switching frequency
- RoHS compliant
- No minimum load
- Input to output isolation: 1600Vdc,min
- Operating case temperature range: 100°C max
- Output over-voltage protection
- Over-current protection, auto-recovery
- Output short circuit protection

Options

- Heat sinks available for extended operation
- Remote on/off and logic configuration

Applications

- Distributed power architectures
- Computer equipment
- Communications equipment

General Description

The PXD10-xxWDxx dual output series offers 10 watts of output power from a 2 X 1 X 0.4 inch package. It has a 4:1 ultra wide input voltage of 9-36VDC, 18-75VDC, features 1600VDC of isolation, short circuit protection, over voltage protection, and six sided shielding. All models are particularly suited for telecommunications, industrial, mobile telecom and test equipment applications.

Table of contents

Absolute Maximum Rating	P2	Thermal Consideration	P21
Output Specification	P2	Remote ON/OFF Control	P22
Input Specification	P3	Heat Sink	P23
General Specification	P4	Mechanical Data	P23
Characteristic Curves	P5	Recommended Pad Layout	P24
Test Configurations	P17	Soldering Considerations	P24
EMC Consideration	P18	Packaging Information	P25
Input Source Impedance	P20	Part Number Structure	P25
Output Over Current Protection	P20	Safety and Installation Instruction	P26
Output Over Voltage Protection	P20	MTBF and Reliability	P26
Short Circuit Protection	P20		

Absolute Maximum Rating				
Parameter	Model	Min	Max	Unit
Input Voltage	24WDxx 48WDxx		36	V_{DC}
			75	
Transient (100ms)	24WDxx 48WDxx		50	
			100	
Operating Ambient Temperature (with derating)	All	-40	85	$^{\circ}C$
Operating Case Temperature			100	$^{\circ}C$
Storage Temperature	All	-55	105	$^{\circ}C$

Output Specification					
Parameter	Model	Min	Typ	Max	Unit
Output Voltage ($V_{in} = V_{in}(nom)$; Full Load; $T_A=25^{\circ}C$)	xxWD05	4.95	5	5.05	V_{DC}
	xxWD12	11.88	12	12.12	
	xxWD15	14.85	15	15.15	
Output Regulation Line ($V_{in}(min)$ to $V_{in}(max)$ at Full Load) Load (0% to 100% of Full Load)	All			± 0.2	%
				± 1.0	
Cross Regulation Asymmetrical Load 25% / 100% of Full Load	All			± 5.0	%
Output Ripple & Noise Peak -to- Peak (20MHz bandwidth)	All			75	mV _{P-P}
Temperature Coefficient	All			± 0.02	$\%/^{\circ}C$
Output Voltage Overshoot ($V_{in} = V_{in}(nom)$; $T_A=25^{\circ}C$)	All		0	5	$\% V_{OUT}$
Dynamic Load Response ($V_{in} = V_{in}(nom)$; $T_A=25^{\circ}C$) Load step change from 75% to 100% or 100 to 75% of Full Load Peak Deviation	All		200		mV
	All		250		μS
Output Current	xxWD05	0		± 1000	mA
	xxWD12	0		± 416	
	xxWD15	0		± 333	
Output Over Voltage Protection (Zener diode clamp)	xxWD05		6.2		V_{DC}
	xxWD12		15		
	xxWD15		18		
Output Over Current Protection	All		130	150	% FL.
Output Short Circuit Protection	Hiccup, automatic recovery				

Input Specification						
Parameter	Model	Min	Typ	Max	Unit	
Operating Input Voltage	24WDxx	9	24	36	V _{DC}	
	48WDxx	18	48	75		
Input Current (Maximum value at V _{in} = V _{in(nom)} ; Full Load)	24WD05			534	mA	
	24WD12			547		
	24WD15			548		
	48WD05			267		
	48WD12			281		
	48WD15			270		
Input Standby current (Typical value at V _{in} = V _{in(nom)} ; No Load)	24WD05		15		mA	
	24WD12		15			
	24WD15		22			
	48WD05		12			
	48WD12		20			
	48WD15		20			
Input reflected ripple current (5 to 20MHz, 12μH source impedance)	All		30		mA _{P-P}	
Start Up Time (V _{in} = V _{in(nom)} and constant resistive load) Power up	All		20		mS	
Remote On/Off Control (Option) (The On/Off pin voltage is referenced to -V _{IN}) Positive logic On/Off pin High Voltage (Remote On) On/Off pin Low Voltage (Remote Off) Negative logic On/Off pin High Voltage (Remote On) On/Off pin Low Voltage (Remote Off)	Suffix -P	3.5		12	V _{DC}	
	Suffix -P	0		1.2		
	Suffix -N	0		1.2		
	Suffix -N	3.5		12		
Remote Off input current	All		20		mA	
Input current of Remote control pin	All	-0.5		1	mA	

General Specification					
Parameter	Model	Min	Typ	Max	Unit
Efficiency ($V_{in} = V_{in(nom)}$; Full Load; $T_A=25^{\circ}C$)	24WD05		82		%
	24WD12		80		
	24WD15		80		
	48WD05		82		
	48WD12		78		
	48WD15		81		
Isolation voltage Input to Output Input to Case, Output to Case	All	1600 1600			V_{DC}
Isolation resistance	All	1			$G\Omega$
Isolation capacitance	All			300	pF
Switching Frequency	All		300		KHz
Weight	All		27.0		g
MTBF Bellcore TR-NWT-000332, $T_C=40^{\circ}C$ MIL-HDBK-217F	All		1.976×10^6 1.416×10^6		hours

Characteristic Curves

All test conditions are at 25°C. The figures are for PXD10-24WD05

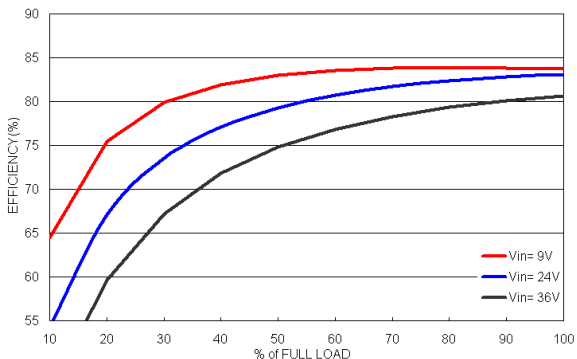

Efficiency versus Output Current

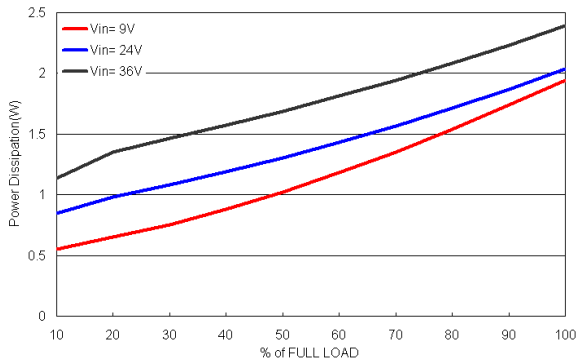

Power Dissipation versus Output Current

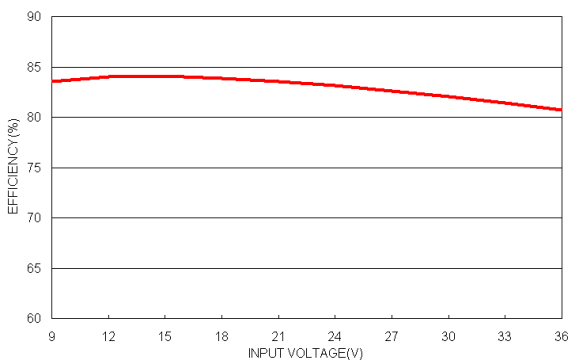

Efficiency versus Input Voltage. Full Load

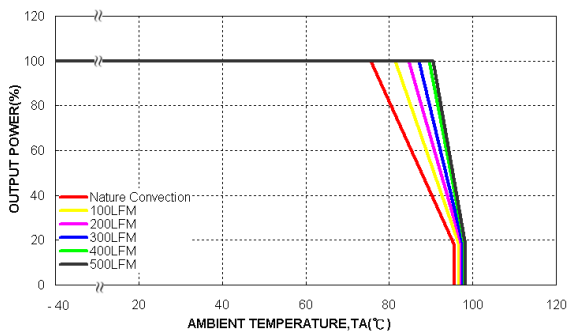

Derating Output Current versus Ambient Temperature and Airflow
Vin = Vin(nom)

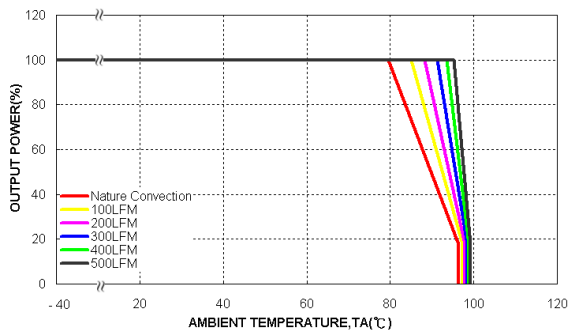

Derating Output Current Versus Ambient Temperature with Heat-Sink
and Airflow, Vin = Vin(nom)

Characteristic Curves (Continued)

All test conditions are at 25°C. The figures are for PXD10-24WD05.

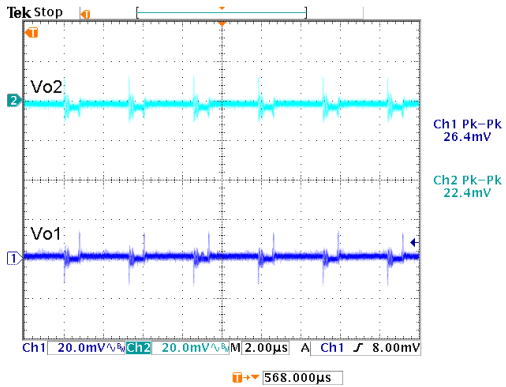

Typical Output Ripple and Noise.
Vin = Vin(nom) ; Full Load

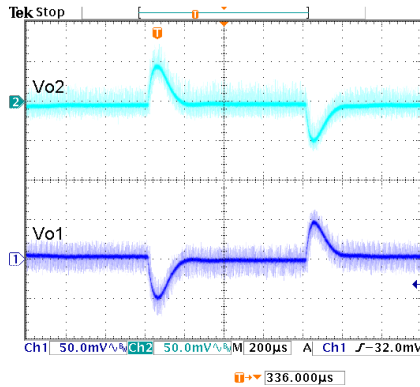

Transient Response to Dynamic Load Change from 100% to 75% to 100% of Full Load ; Vin = Vin(nom)

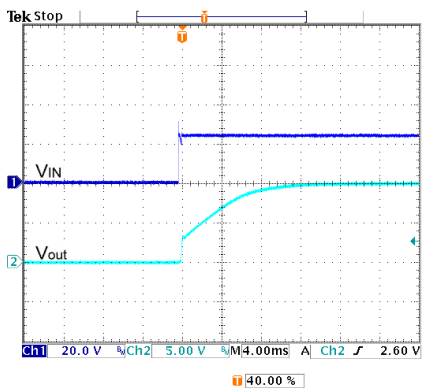

Typical Input Start-up and Output Rise Characteristic
Vin = Vin(nom) ; Full Load

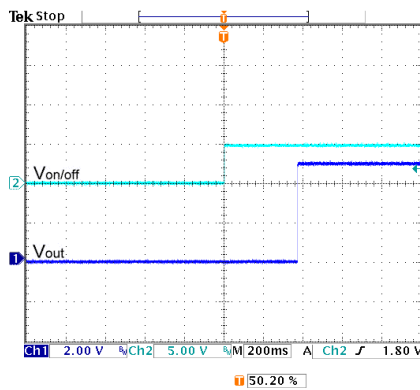

Using ON/OFF Voltage Start-up and Vo Rise Characteristic
Vin = Vin(nom) ; Full Load

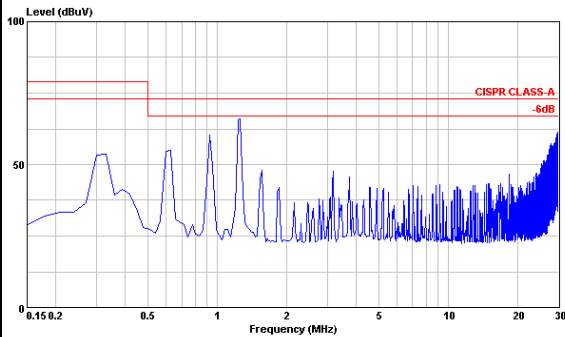

Conduction Emission of EN55022 Class A
Vin = Vin(nom) ; Full Load

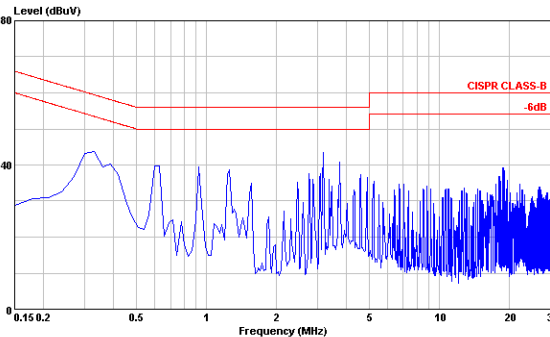

Conduction Emission of EN55022 Class B
Vin = Vin(nom) ; Full Load

Characteristic Curves (Continued)

All test conditions are at 25°C. The figures are for PXD10-24WD12.

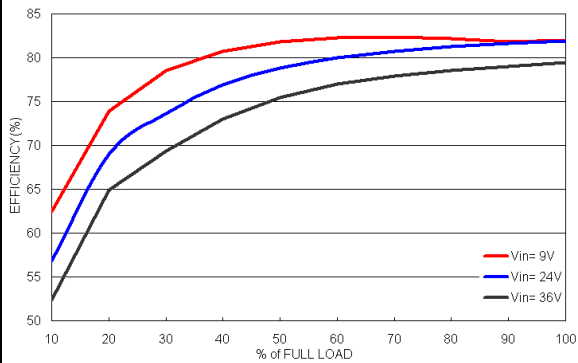

Efficiency versus Output Current

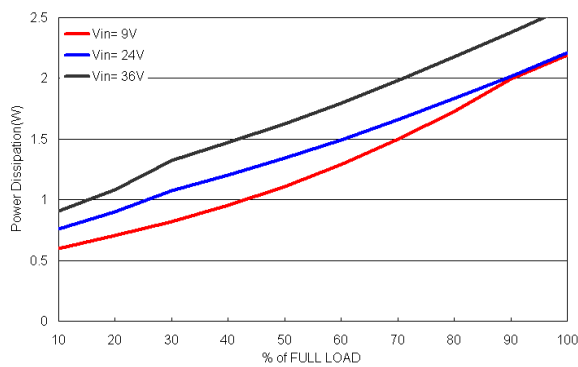

Power Dissipation versus Output Current

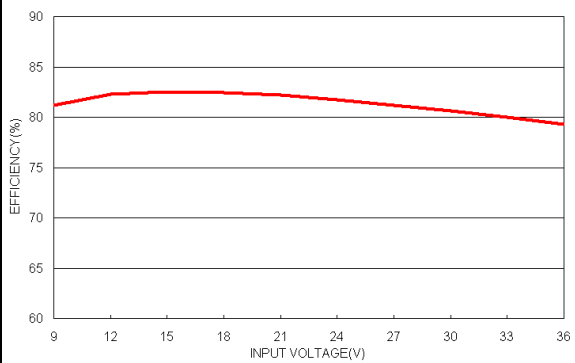

Efficiency versus Input Voltage. Full Load

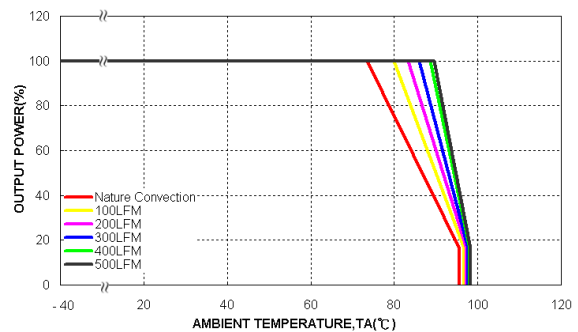

Derating Output Current versus Ambient Temperature and Airflow
Vin = Vin(nom)

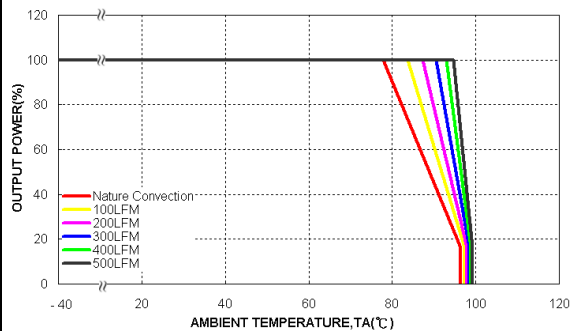

Derating Output Current Versus Ambient Temperature with Heat-Sink
and Airflow, Vin = Vin(nom)

Characteristic Curves (Continued)

All test conditions are at 25°C. The figures are for PXD10-24WD12.

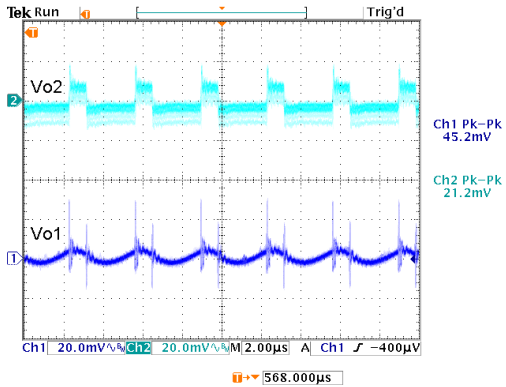

Typical Output Ripple and Noise.
Vin = Vin(nom) ; Full Load

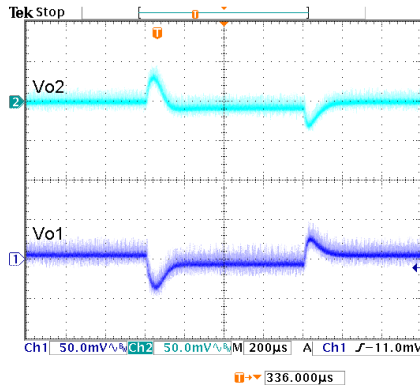

Transient Response to Dynamic Load Change from
100% to 75% to 100% of Full Load ; Vin = Vin(nom)

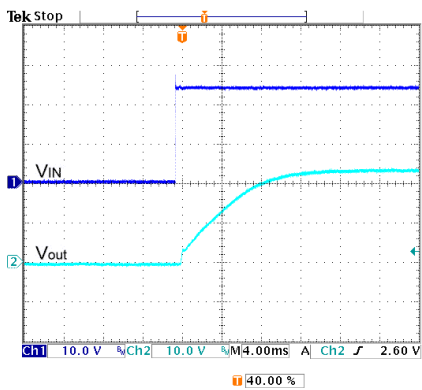

Typical Input Start-up and Output Rise Characteristic
Vin = Vin(nom) ; Full Load

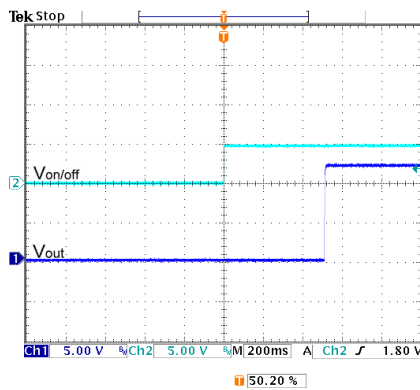

Using ON/OFF Voltage Start-up and Vo Rise Characteristic
Vin = Vin(nom) ; Full Load

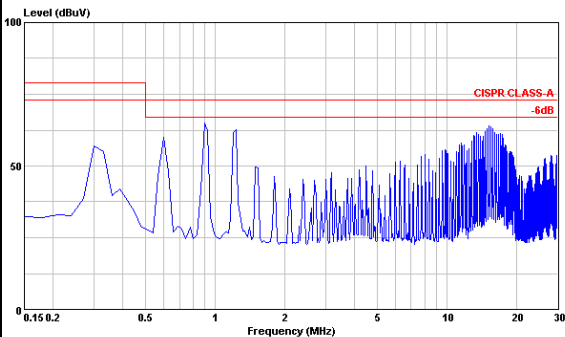

Conduction Emission of EN55022 Class A
Vin = Vin(nom) ; Full Load

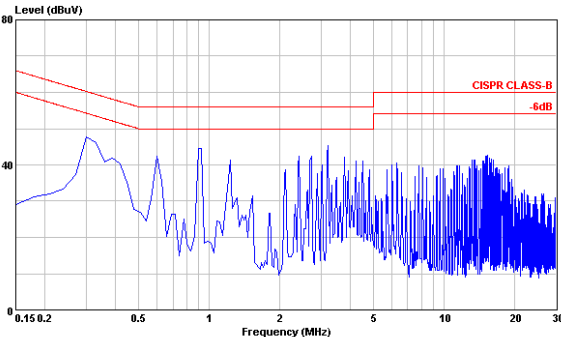

Conduction Emission of EN55022 Class B
Vin = Vin(nom) ; Full Load

Characteristic Curves (Continued)

All test conditions are at 25°C. The figures are for PXD10-24WD15.

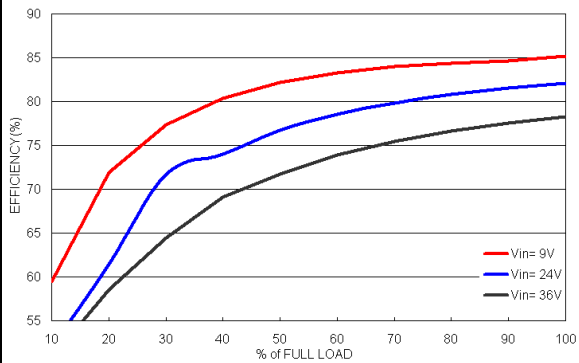

Efficiency versus Output Current

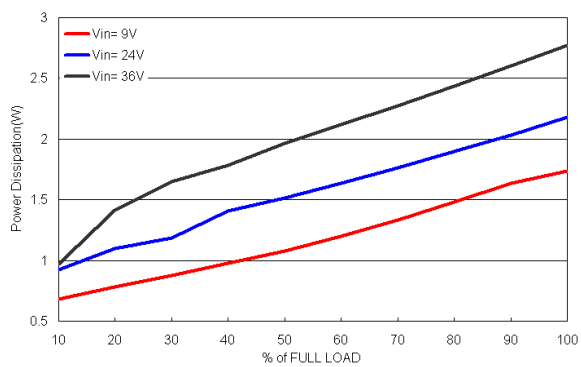

Power Dissipation versus Output Current

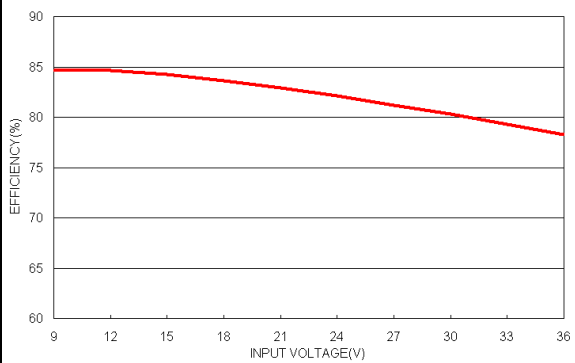

Efficiency versus Input Voltage. Full Load

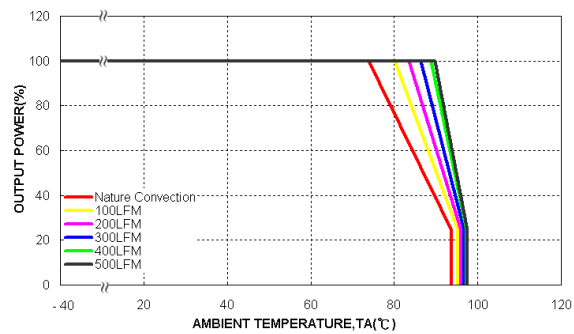

Derating Output Current versus Ambient Temperature and Airflow
Vin = Vin(nom) ;

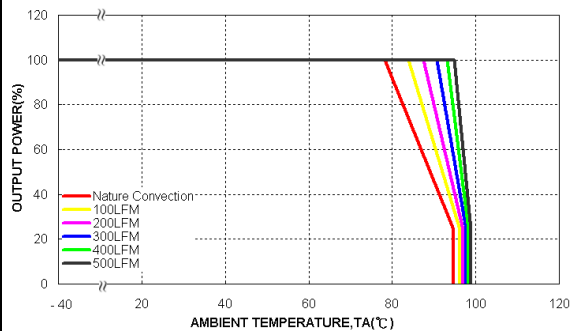

Derating Output Current Versus Ambient Temperature with Heat-Sink
and Airflow , Vin = Vin(nom)

Characteristic Curves (Continued)

All test conditions are at 25°C. The figures are for PXD10-24WD15.

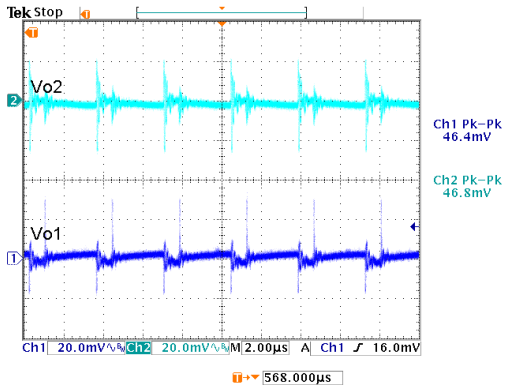

Typical Output Ripple and Noise.
Vin = Vin(nom) ; Full Load

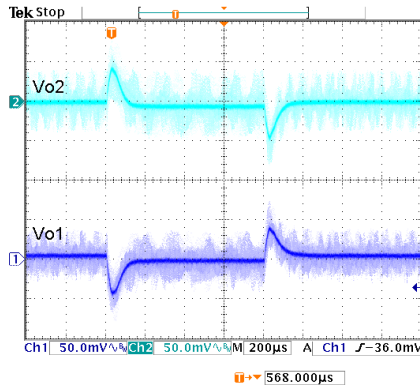

Transient Response to Dynamic Load Change from
100% to 75% to 100% of Full Load ; Vin = Vin(nom)

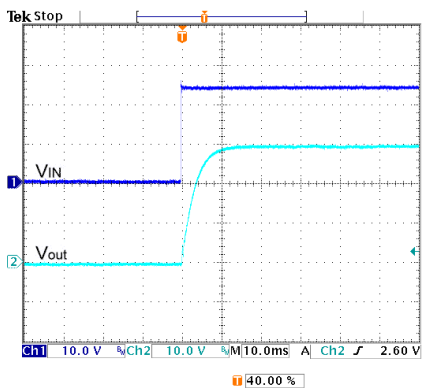

Typical Input Start-up and Output Rise Characteristic
Vin = Vin(nom) ; Full Load

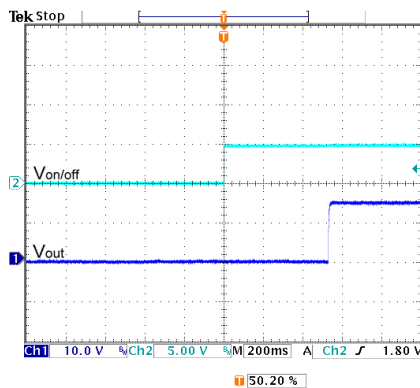

Using ON/OFF Voltage Start-up and Vo Rise Characteristic
Vin = Vin(nom) ; Full Load

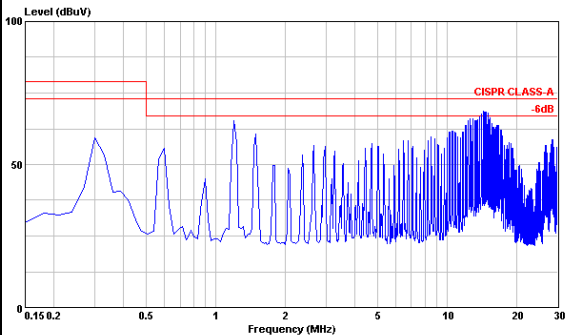

Conduction Emission of EN55022 Class A
Vin = Vin(nom) ; Full Load

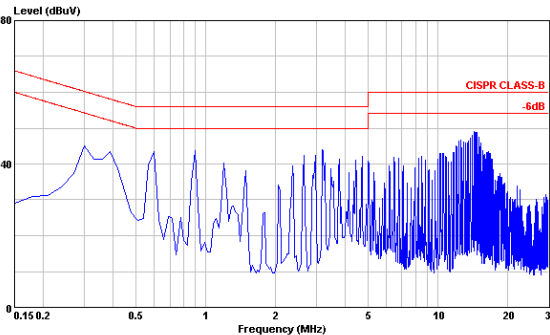

Conduction Emission of EN55022 Class B
Vin = Vin(nom) ; Full Load

Characteristic Curves (Continued)

All test conditions are at 25°C. The figures are for PXD10-48WD05.

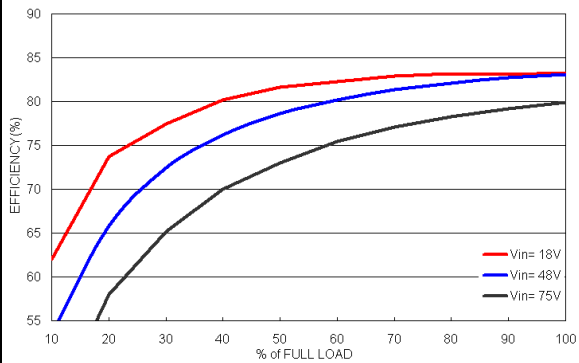

Efficiency versus Output Current

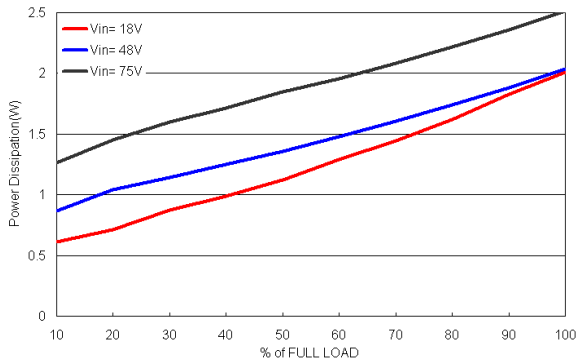

Power Dissipation versus Output Current

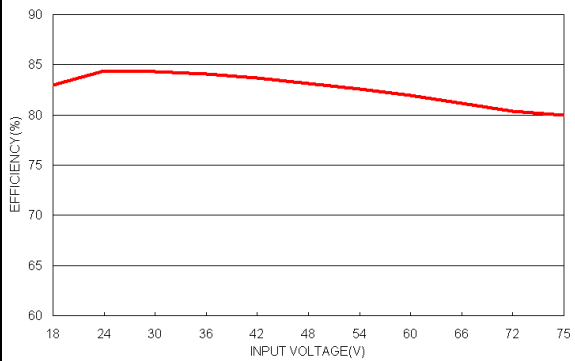

Efficiency versus Input Voltage. Full Load

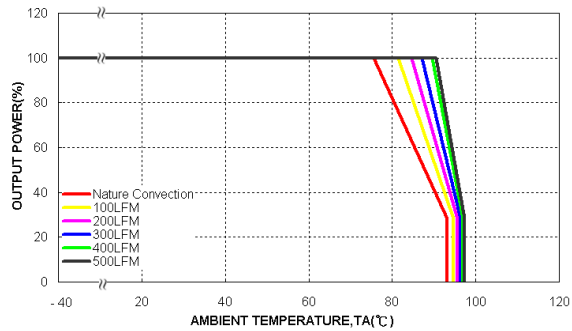

Derating Output Current versus Ambient Temperature and Airflow
Vin = Vin(nom)

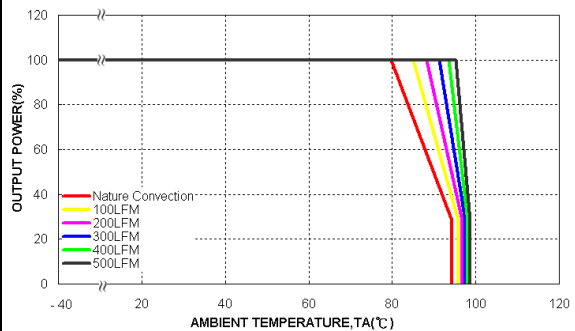

Derating Output Current Versus Ambient Temperature with Heat-Sink
and Airflow, Vin = Vin(nom)

Characteristic Curves (Continued)

All test conditions are at 25°C . The figures are or PXD10-48WD05.

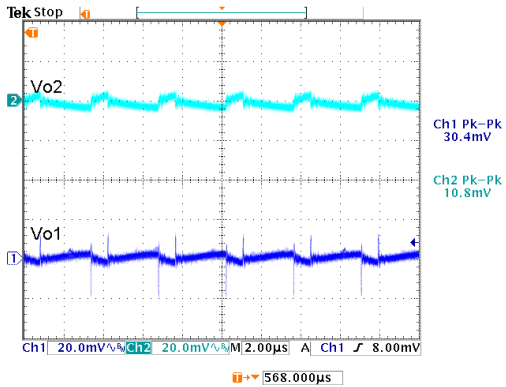

Typical Output Ripple and Noise.
Vin = Vin(nom) ; Full Load

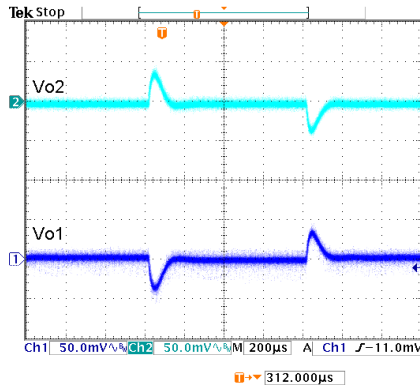

Transient Response to Dynamic Load Change from
100% to 75% to 100% of Full Load ; Vin = Vin(nom)

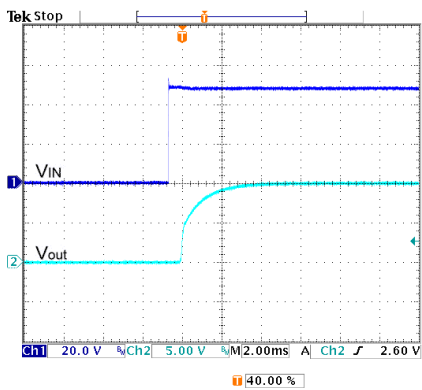

Typical Input Start-up and Output Rise Characteristic
Vin = Vin(nom) ; Full Load

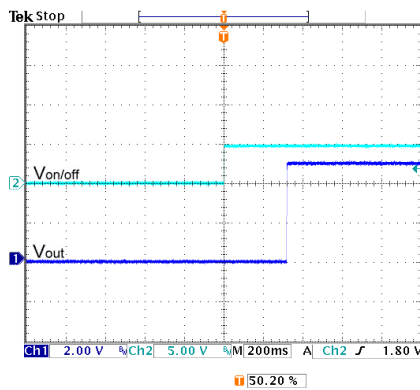

Using ON/OFF Voltage Start-up and Vo Rise Characteristic
Vin = Vin(nom) ; Full Load

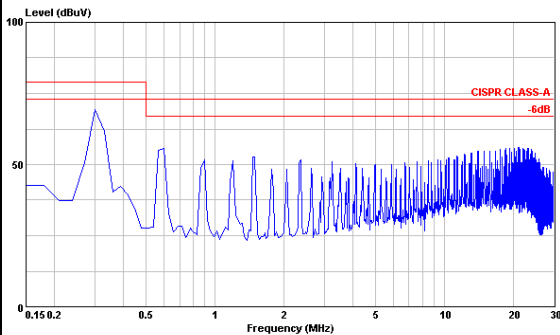

Conduction Emission of EN55022 Class A
Vin = Vin(nom) ; Full Load

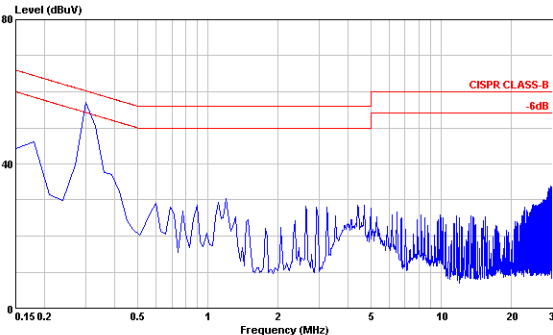

Conduction Emission of EN55022 Class B
Vin = Vin(nom) ; Full Load

Characteristic Curves (Continued)

All test conditions are at 25°C .The figures are for PXD10-48WD12 .

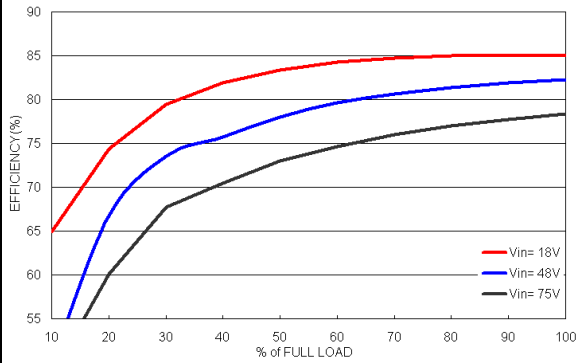

Efficiency versus Output Current

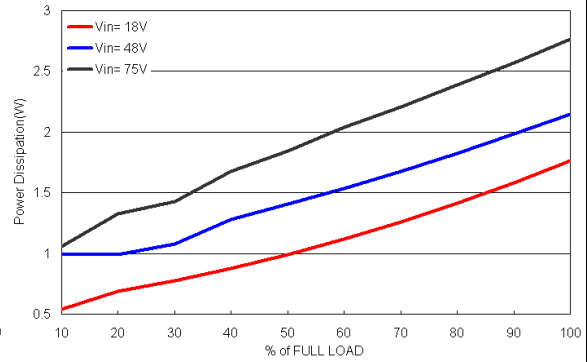

Power Dissipation versus Output Current

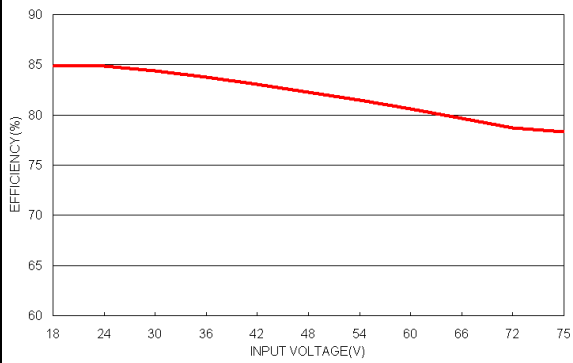

Efficiency versus Input Voltage. Full Load

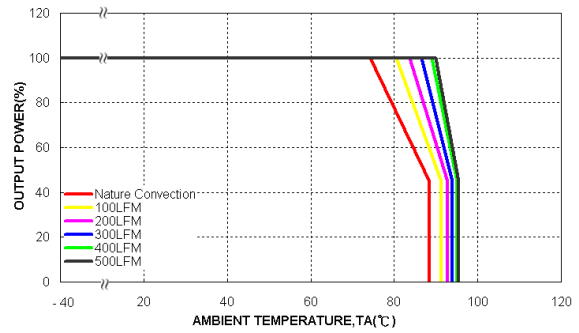

Derating Output Current versus Ambient Temperature and Airflow
Vin = Vin(nom)

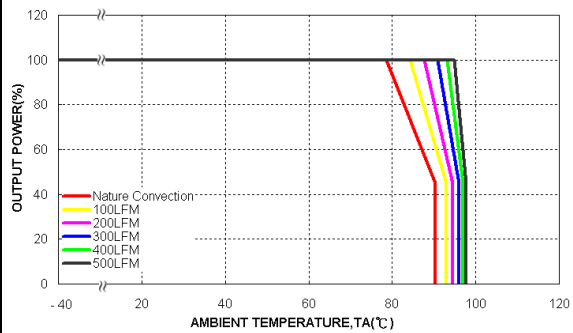

Derating Output Current Versus Ambient Temperature with Heat-Sink
and Airflow , Vin = Vin(nom)

Characteristic Curves (Continued)

All test conditions are at 25°C. The figures are for PXD10-48WD12.

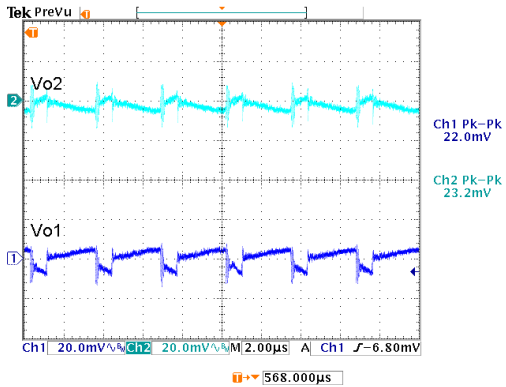

Typical Output Ripple and Noise.
Vin = Vin(nom) ; Full Load

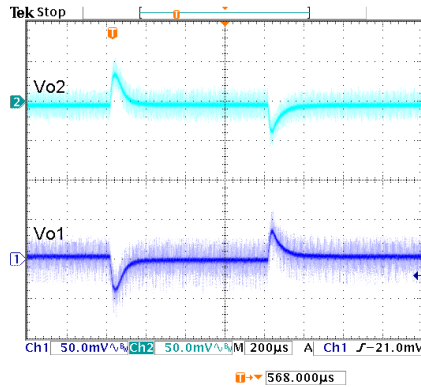

Transient Response to Dynamic Load Change from 100% to 75% to 100% of Full Load ; Vin = Vin(nom)

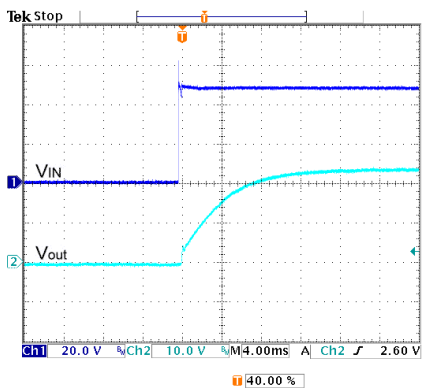

Typical Input Start-up and Output Rise Characteristic
Vin = Vin(nom) ; Full Load

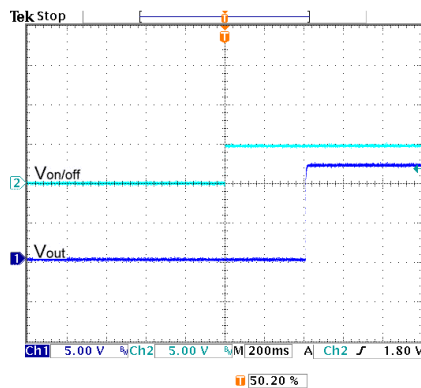

Using ON/OFF Voltage Start-up and Vo Rise Characteristic
Vin = Vin(nom) ; Full Load

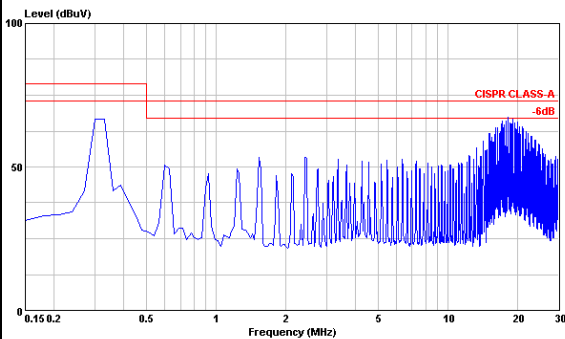

Conduction Emission of EN55022 Class A
Vin = Vin(nom) ; Full Load

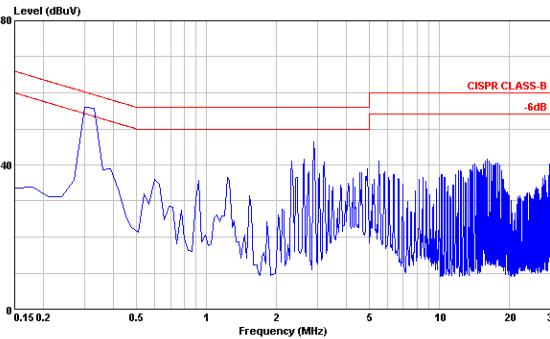

Conduction Emission of EN55022 Class B
Vin = Vin(nom) ; Full Load

Characteristic Curves (Continued)

All test conditions are at 25°C. The figures are for PXD10-48WD15.

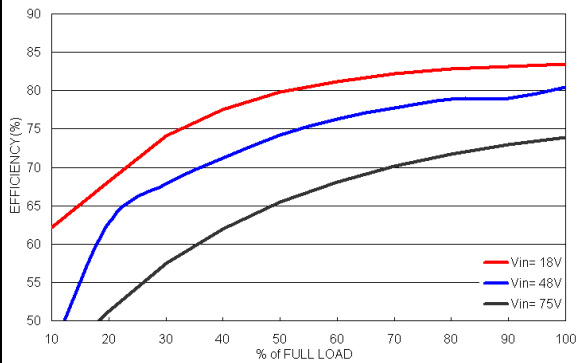

Efficiency versus Output Current

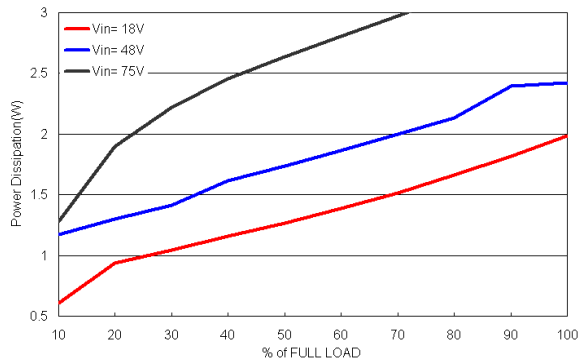

Power Dissipation versus Output Current

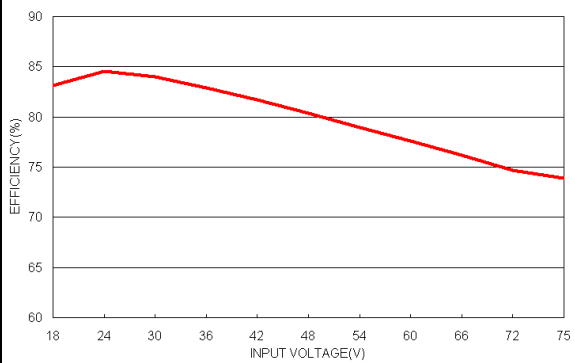

Efficiency versus Input Voltage. Full Load

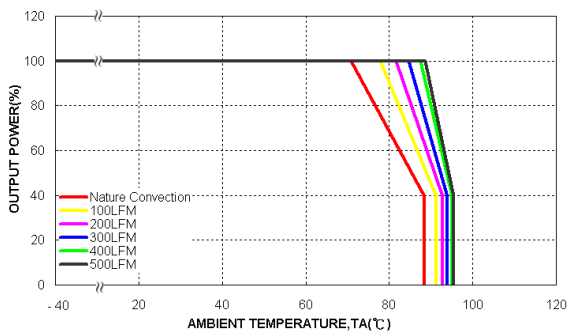

Derating Output Current versus Ambient Temperature and Airflow
Vin = Vin(nom)

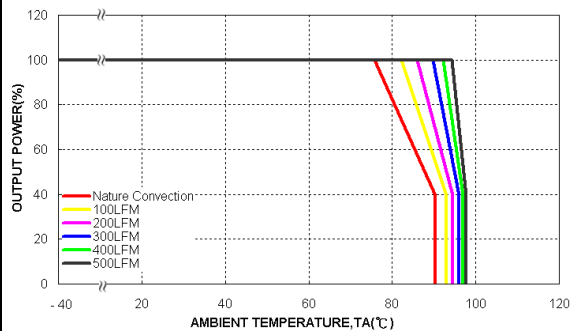

Derating Output Current Versus Ambient Temperature with Heat-Sink and Airflow, Vin = Vin(nom)

Characteristic Curves (Continued)

All test conditions are at 25°C. The figures are for PXD10-48WD15.

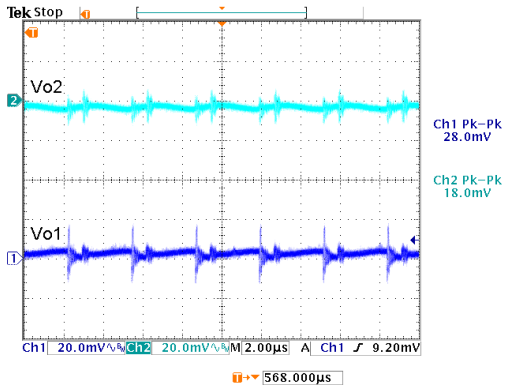

Typical Output Ripple and Noise.
Vin = Vin(nom) ; Full Load

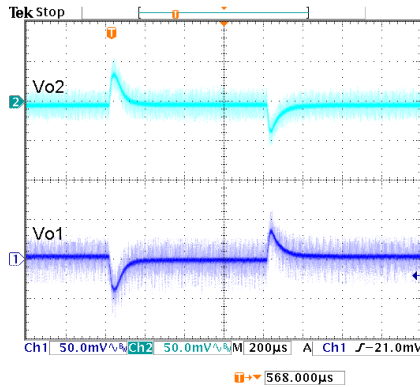

Transient Response to Dynamic Load Change from 100% to 75% to 100% of Full Load ; Vin = Vin(nom)

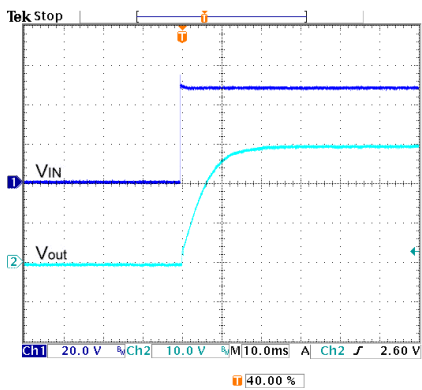

Typical Input Start-up and Output Rise Characteristic
Vin = Vin(nom) ; Full Load

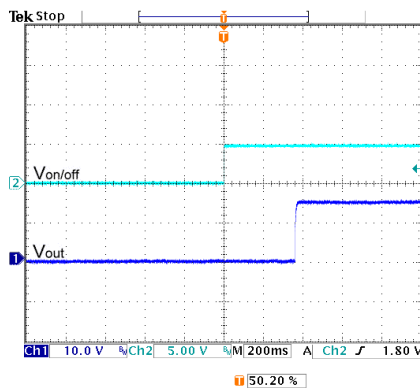

Using ON/OFF Voltage Start-up and Vo Rise Characteristic
Vin = Vin(nom) ; Full Load

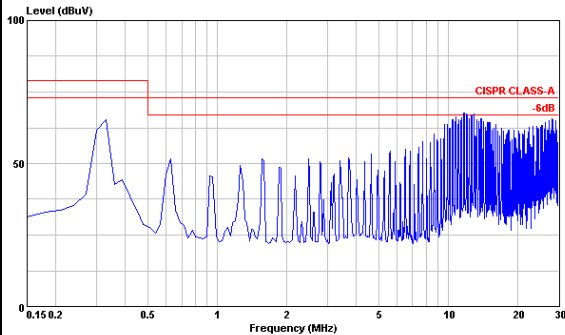

Conduction Emission of EN55022 Class A
Vin, nom ; Full Load

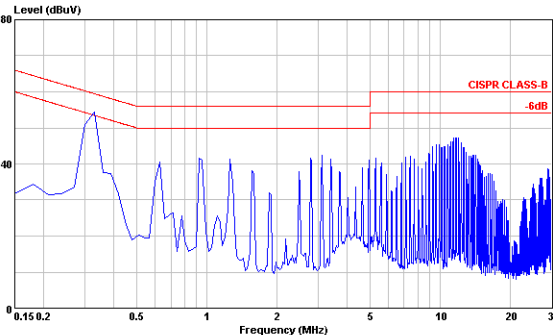

Conduction Emission of EN55022 Class B
Vin = Vin(nom) ; Full Load

Test Configurations

Input reflected-ripple current measurement test

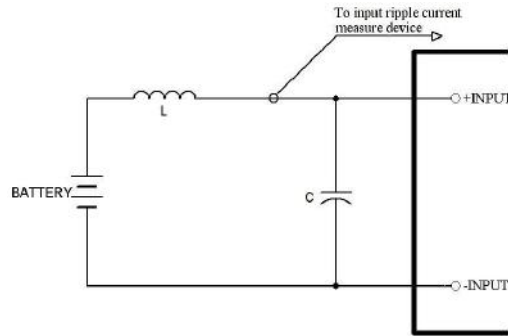

Component	Value	Voltage	Reference
L	12μH	----	----
C	100μF	100V	Aluminum Electrolytic Capacitor

Peak-to-peak output ripple & noise measurement test

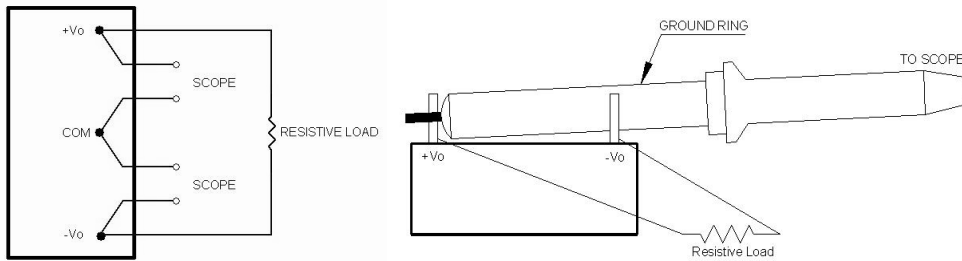

Output voltage and efficiency measurement test

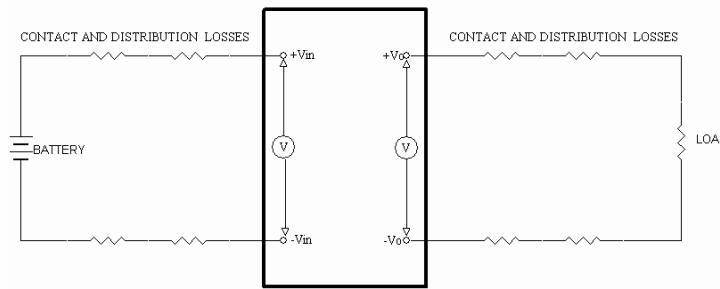

Note: All measurements are taken at the module terminals.

$$Efficiency = \left(\frac{V_o \times I_o}{V_{in} \times I_{in}} \right) \times 100\%$$

EMC Considerations

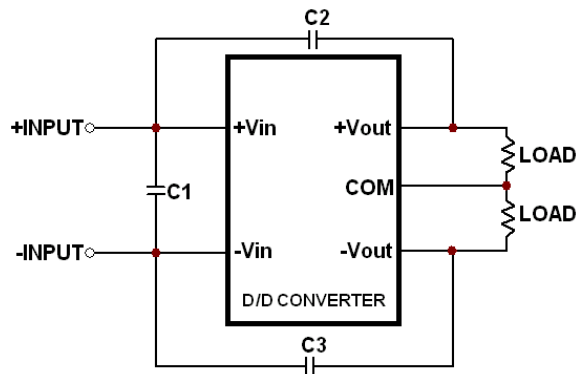

Suggested schematic for EN55022 conducted emission Class A limits

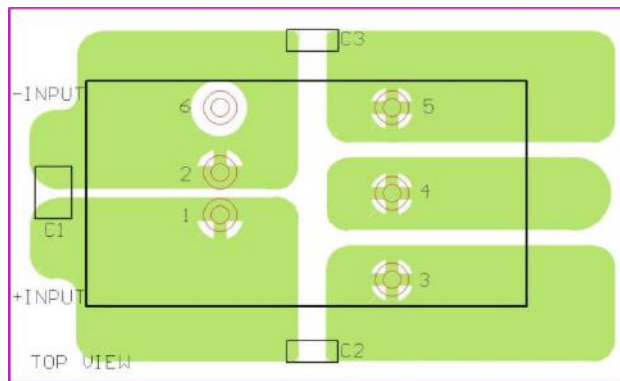

Recommended layout with input filter

To meet conducted emissions EN55022 CLASS A needed the following components:

PXD10-24WDxx

Component	Value	Voltage	Reference
C1	1 μ F	50V	1210 MLCC
C2,C3	1000pF	2KV	1808 MLCC

PXD10-48WDxx

Component	Value	Voltage	Reference
C1	1.5 μ F	100V	1812 MLCC
C2,C3	1000pF	2KV	1808 MLCC

EMC Considerations (Continued)

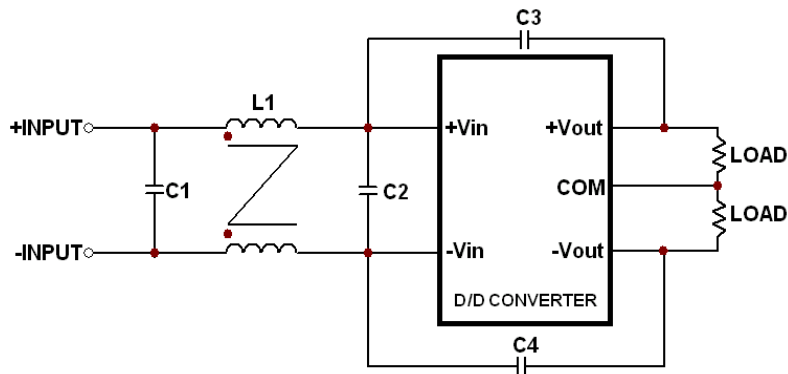

Suggested schematic for EN55022 conducted emission Class B limits

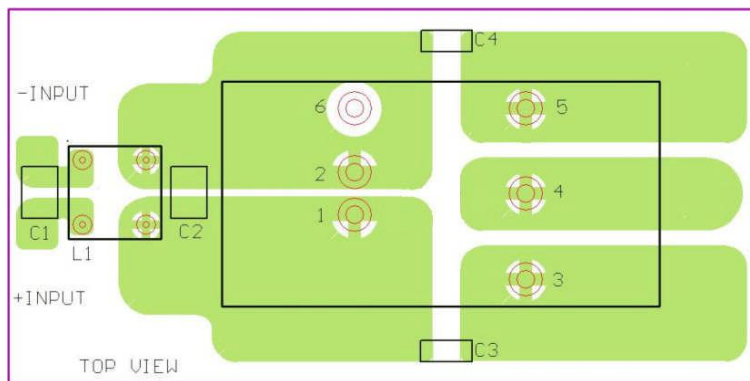

Recommended layout with input filter

To meet conducted emissions EN55022 CLASS B needed the following components:

PXD10-24WDxx

Component	Value	Voltage	Reference
C1	2.2 μ F	50V	1812 MLCC
C3,C4	1000pF	2KV	1808 MLCC
L1	325 μ H	----	Common Choke

PXD10-48WDxx

Component	Value	Voltage	Reference
C1,C2	2.2 μ F	100V	1812 MLCC
C3,C4	1000pF	2KV	1808 MLCC
L1	325 μ H	----	Common Choke

This Common Choke L1 has been define as follows:

- L : 325 μ H \pm 35% / DCR: 35m Ω , max
- A height: 8.8 mm, Max
- Test condition: 100KHz / 100mV
- Recommended through hole: Φ 0.8mm
- All dimensions in millimeters

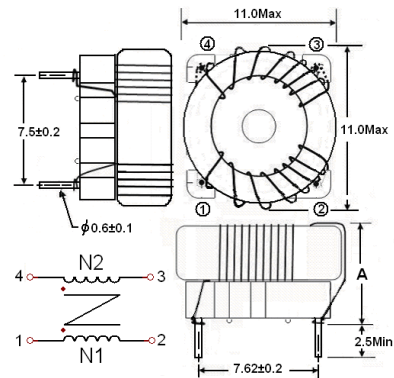

Input Source Impedance

The converter should be connected to a low impedance input source. Highly inductive source impedance can affect the stability of the converter. Input external L-C filter is recommended to minimize input reflected ripple current. The inductor has a source impedance of 12 μ H and capacitor is Nippon chemi-con KY series 100 μ F/100V. The capacitor must be located as close as possible to the input terminals of the converter for lowest impedance.

Output Over Current Protection

When excessive output currents occur in the system, circuit protection is required on all converters. Normally, overload current is maintained at approximately 150 percent of rated current for PXF40-xxSxx series.

Hiccup-mode is a method of operation in a converter whose purpose is to protect the power supply from being damaged during an over-current fault condition. It also enables the converter to restart when the fault is removed. There are other ways of protecting the converter when it is over-loaded, such as the maximum current limiting or current foldback methods.

One of the problems resulting from over current is that excessive heat may be generated in power devices; especially MOSFET and Schottky diodes and the temperature of these devices may exceed their specified limits. A protection mechanism has to be used to prevent these power devices from being damaged.

The operation of hiccup is as follows. When the current sense circuit sees an over-current event, the controller shuts off the converter for a given time and then tries to start up the converter again. If the over-load condition has been removed, the converter will start up and operate normally; otherwise, the controller will see another over-current event and will shut off the converter again, repeating the previous cycle. Hiccup operation has none of the drawbacks of the other two protection methods, although its circuit is more complicated because it requires a timing circuit. The excess heat due to overload lasts for only a short duration in the hiccup cycle, hence the junction temperature of the power devices is much lower.

Output Over Voltage Protection

The output over-voltage protection consists of an output Zener diode that monitors the voltage on the output terminals. If the voltage on the output terminals exceeds the over-voltage protection threshold, then the Zener diode clamps the output voltage.

Short Circuitry Protection

Continuous, hiccup and auto-recovery mode.

Thermal Consideration

The converter operates in a variety of thermal environments; however, sufficient cooling should be provided to help ensure reliable operation of the unit. Heat is removed by conduction, convection, and radiation to the surrounding environment. Proper cooling can be verified by measuring the point as shown in the figure below. The temperature at this location should not exceed 100°C. When Operating, adequate cooling must be provided to maintain the test point temperature at or below 100°C. Although the maximum point temperature of the converter is 100°C, lowering this temperature yields higher reliability.

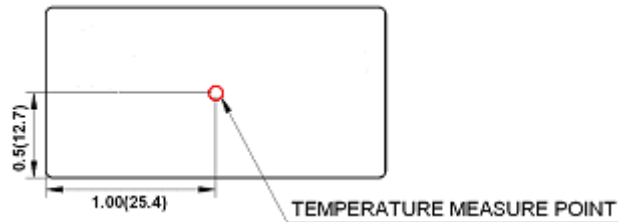

Measurement shown in inches(mm)

TOP VIEW

Remote ON/OFF Control (Option)

Remote control is an optional feature.

Positive logic:

Turns the module On during logic High on the On/Off pin and turns Off during logic Low.

Negative logic:

Turns the module On during logic Low on the On/Off pin and turns Off during logic High.

The On/Off pin is an open collector/drain logic input signal ($V_{on/off}$) that referenced to $-V_{IN}$.

Remote On/Off Implementation

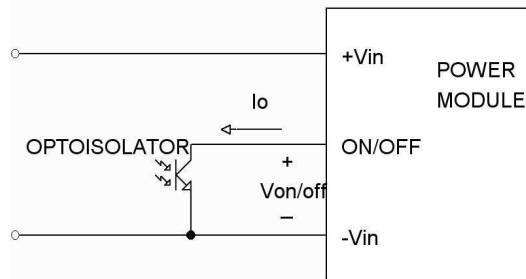

Isolated-Control Remote On/Off

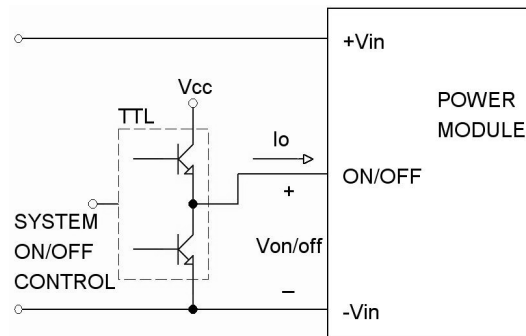

Level Control Using TTL Output

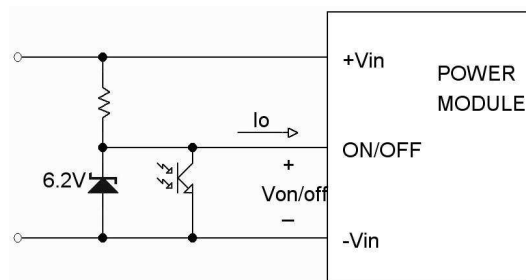

Level Control Using Line Voltage

Heat Sink

Use heat-sink (7G-0020A) for lower temperature and higher reliability of the module.

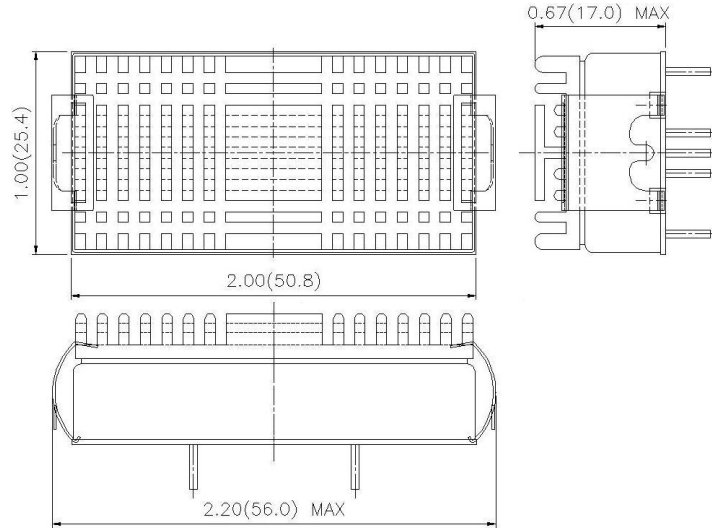

All dimensions in Inches (mm)

Mechanical Data

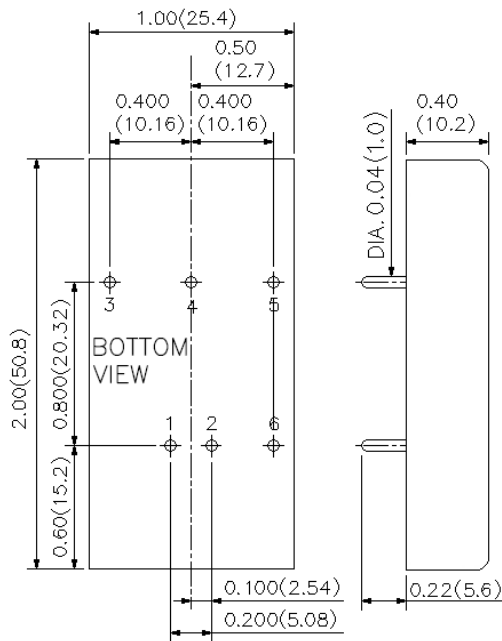

PIN CONNECTION	
PIN	FUNCTION
1	+ INPUT
2	- INPUT
3	+ OUTPUT
4	COMMON
5	- OUTPUT
6	CTRL (Option)

1. All dimensions in Inches (mm)
Tolerance: x.xx±0.02 (x.x±0.5)
x.xxx±0.01 (x.xx±0.25)
2. Pin pitch tolerance ±0.01(0.25)
3. Pin dimension tolerance ±0.014(0.35)

Recommended Pad Layout

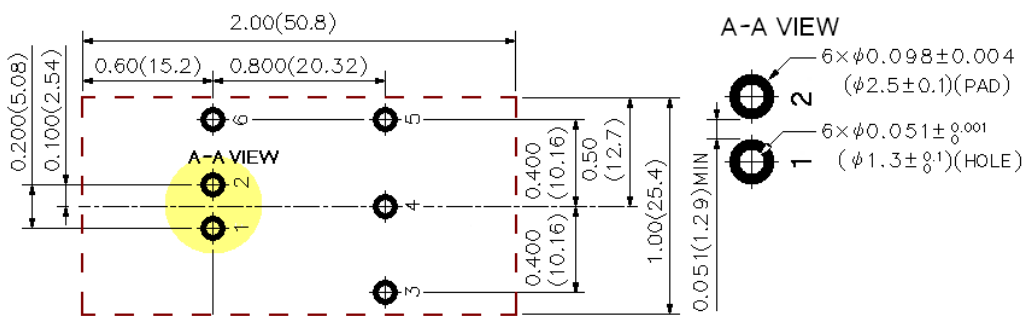

1. All dimensions in Inches (mm)
Tolerance: $x.xx \pm 0.02$ ($x.x \pm 0.5$)
 $x.xxx \pm 0.01$ ($x.xx \pm 0.25$)
2. Pin pitch tolerance ± 0.01 (0.25)

Soldering and Reflow Considerations

Lead free wave solder profile for PXD10-xxWDxx series.

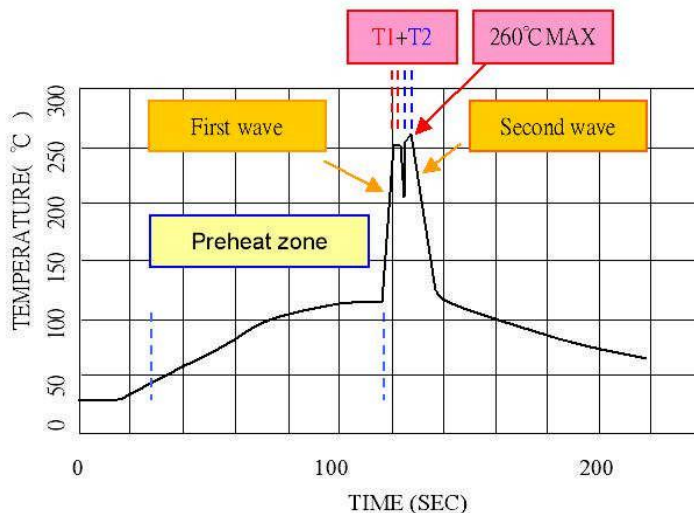

Zone	Reference Parameter
Preheat zone	Rise temp. speed : 3°C / sec max. Preheat temp. : 100~130°C
Actual heating	Peak temp. : 250~260°C Peak time (T1+T2 time) : 4~6 sec

Reference Solder: Sn-Ag-Cu/Sn-Cu

Hand Welding: Soldering iron-Power 90W

Welding Time: 2-4 sec

Temp.: 380-400 °C

Packaging Information

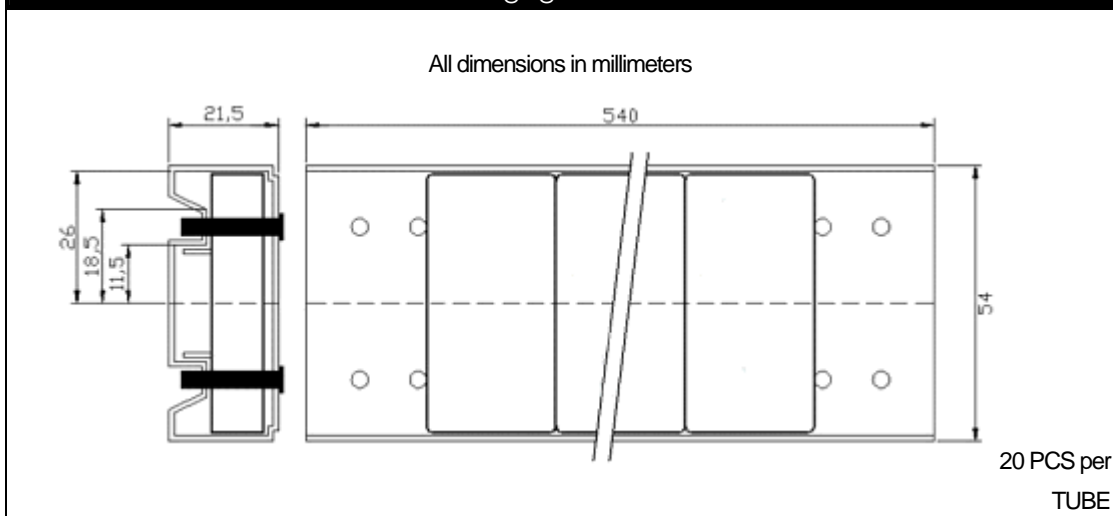

Part Number Structure

PXD 10 - 48 WD 05 - P

Max. Output Power
10 Watts

Input Voltage Range
24 9 ~ 36V
48 18 ~ 75V

4:1 Ultra Wide Input Range

Dual Output

Remote Control
No Suffix: Without Remote Control
Suffix -P: Positive Logic
Suffix -N: Negative Logic

Output Voltage
05 ±5VDC
12 ±12VDC
15 ±15VDC

Model Number	Input Range	Output Voltage	Output Current		Eff ⁽²⁾ (%)
			Max. Load	Full Load ⁽¹⁾	
PXD10-24WD05	9 - 36 VDC	±5VDC	±1000mA	534mA	82
PXD10-24WD12	9 - 36 VDC	±12VDC	±416mA	547mA	80
PXD10-24WD15	9 - 36 VDC	±15VDC	±333mA	548mA	80
PXD10-48WD05	18 - 75 VDC	±5VDC	±1000mA	267mA	82
PXD10-48WD12	18 - 75 VDC	±12VDC	±416mA	281mA	78
PXD10-48WD15	18 - 75 VDC	±15VDC	±333mA	270mA	81

Note 1. Maximum value at nominal input voltage and full load of standard type.
Note 2. Typical value at nominal input voltage and full load.

Safety and Installation Instruction**Fusing Consideration**

Caution: This converter is not internally fused. An input line fuse must always be used.

This encapsulated converter can be used in a wide variety of applications, ranging from simple stand-alone operation to an integrated part of a sophisticated power architecture. For maximum flexibility, internal fusing is not included; however, to achieve maximum safety and system protection, always use an input line fuse. The safety agencies require a slow-blow fuse with maximum rating of 5A. Based on the information provided in this data sheet on Inrush energy and maximum dc input current; the same type of fuse with lower rating can be used. Refer to the fuse manufacturer's data for further information.

MTBF and Reliability**The MTBF of PxD10-xxWDxx series of DC/DC converters has been calculated using**

Bellcore TR-NWT-000332 Case I: 50% stress, Operating Temperature at 40°C (Ground fixed and controlled environment). The resulting figure for MTBF is 1.976×10^6 hours.

MIL-HDBK 217F NOTICE2 FULL LOAD, Operating Temperature at 25 °C The resulting figure for MTBF is 1.416×10^6 hours.