

Features

- -20V/-5A,
 $R_{DS(ON)} = 20m\Omega(Typ.)@V_{GS} = -4.5V$
 $R_{DS(ON)} = 30m\Omega(Typ.)@V_{GS} = -2.5V$
- Low On-Resistance
- Super High Dense Cell Design
- Reliable and Rugged
- Lead Free and Green Devices Available (RoHS Compliant)

Applications

- Load Switch
- Power Management
- Battery Protection

Pin Description

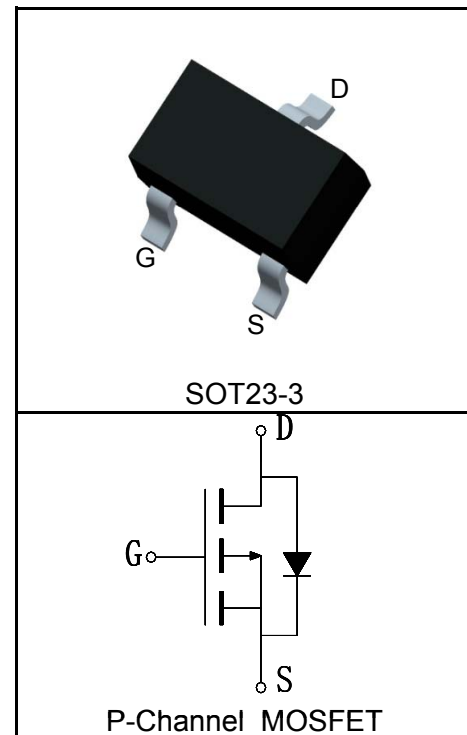

Absolute Maximum Ratings

Symbol	Parameter	Rating	Unit
Common Ratings ($T_A = 25^\circ C$ Unless Otherwise Noted)			
V_{DSS}	Drain-Source Voltage	-20	V
V_{GSS}	Gate-Source Voltage	± 16	
T_J	Maximum Junction Temperature	150	$^\circ C$
T_{STG}	Storage Temperature Range	-55 to 150	$^\circ C$
I_S	Diode Continuous Forward Current	$T_A = 25^\circ C$ -1	A
Mounted on Large Heat Sink			
$I_{DP}^{①}$	300 μs Pulse Drain Current Tested	$T_A = 25^\circ C$ -20	A
$I_D^{②}$	Continuous Drain Current ($V_{GS} = -4.5V$)	$T_A = 25^\circ C$ -5	A
		$T_A = 70^\circ C$ -4	
P_D	Maximum Power Dissipation	$T_A = 25^\circ C$ 1.3	W
		$T_A = 70^\circ C$ 0.8	
$R_{\theta JC}$	Thermal Resistance-Junction to Case	-	$^\circ C/W$
$R_{\theta JA}^{③}$	Thermal Resistance-Junction to Ambient	100	$^\circ C/W$
Drain-Source Avalanche Ratings			
$E_{AS}^{④}$	Avalanche Energy, Single Pulsed	-	mJ

Electrical Characteristics ($T_A=25^{\circ}\text{C}$ Unless Otherwise Noted)

Symbol	Parameter	Test Condition	RU20P7C			Unit
			Min.	Typ.	Max.	
Static Characteristics						
BV_{DSS}	Drain-Source Breakdown Voltage	$V_{GS}=0V, I_{DS}=-250\mu A$	-20			V
I_{DSS}	Zero Gate Voltage Drain Current	$V_{DS}=-20V, V_{GS}=0V$			-1	μA
		$T_J=125^{\circ}\text{C}$			-30	
$V_{GS(th)}$	Gate Threshold Voltage	$V_{DS}=V_{GS}, I_{DS}=-250\mu A$	-0.4	-0.7	-1.1	V
I_{GSS}	Gate Leakage Current	$V_{GS}=\pm 16V, V_{DS}=0V$			± 100	nA
$R_{DS(ON)}^{(5)}$	Drain-Source On-state Resistance	$V_{GS}=-4.5V, I_{DS}=-5A$		20	28	$m\Omega$
		$V_{GS}=-2.5V, I_{DS}=-4A$		30	38	$m\Omega$
Diode Characteristics						
$V_{SD}^{(5)}$	Diode Forward Voltage	$I_{SD}=-1A, V_{GS}=0V$			-1.2	V
t_{rr}	Reverse Recovery Time	$I_{SD}=-5A, di_{SD}/dt=100A/\mu s$		17		ns
Q_{rr}	Reverse Recovery Charge			23		nC
Dynamic Characteristics ^⑥						
R_G	Gate Resistance	$V_{GS}=0V, V_{DS}=0V, F=1\text{MHz}$		0.9		Ω
C_{iss}	Input Capacitance	$V_{GS}=0V, V_{DS}=-10V, \text{Frequency}=1.0\text{MHz}$		640		pF
C_{oss}	Output Capacitance			135		
C_{rss}	Reverse Transfer Capacitance			65		
$t_{d(ON)}$	Turn-on Delay Time	$V_{DD}=-10V, R_L=3.8\Omega, I_{DS}=-5A, V_{GEN}=-4.5V, R_G=6\Omega$		9		ns
t_r	Turn-on Rise Time			16		
$t_{d(OFF)}$	Turn-off Delay Time			45		
t_f	Turn-off Fall Time			21		
Gate Charge Characteristics ^⑥						
Q_g	Total Gate Charge	$V_{DS}=-16V, V_{GS}=-10V, I_{DS}=-5A$		10		nC
Q_{gs}	Gate-Source Charge			2		
Q_{gd}	Gate-Drain Charge			3		

- Notes:
- ① Pulse width limited by safe operating area.
 - ② Calculated continuous current based on maximum allowable junction temperature.
 - ③ When mounted on 1 inch square copper board, $t \leq 10\text{sec}$. The value in any given application depends on the user's specific board design.
 - ④ Limited by T_{Jmax} . Starting $T_J = 25^{\circ}\text{C}$.
 - ⑤ Pulse test; Pulse width $\leq 300\mu s$, duty cycle $\leq 2\%$.
 - ⑥ Guaranteed by design, not subject to production testing.

Ordering and Marking Information

Device	Marking ^①	Package	Packaging	Quantity	Reel Size	Tape width
RU20P7C	TXYWW	SOT23-3	Tape&Reel	3000	7"	8mm

① The following characters could be different and means:

X =Assembly site code

Y =Year

WW =Work Week

Typical Characteristics

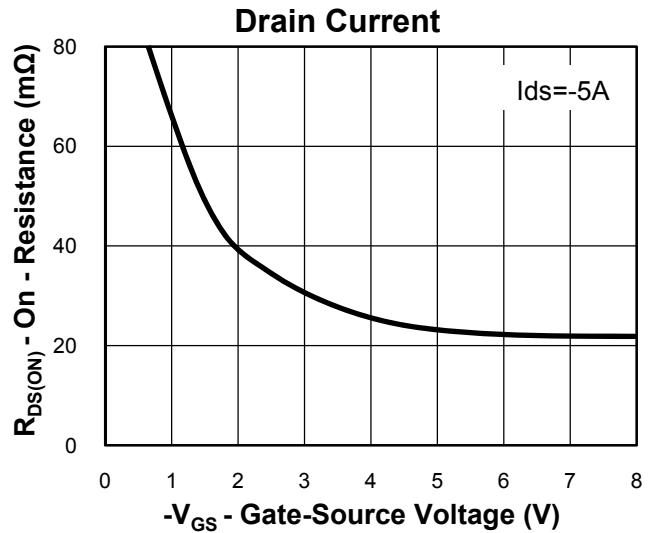
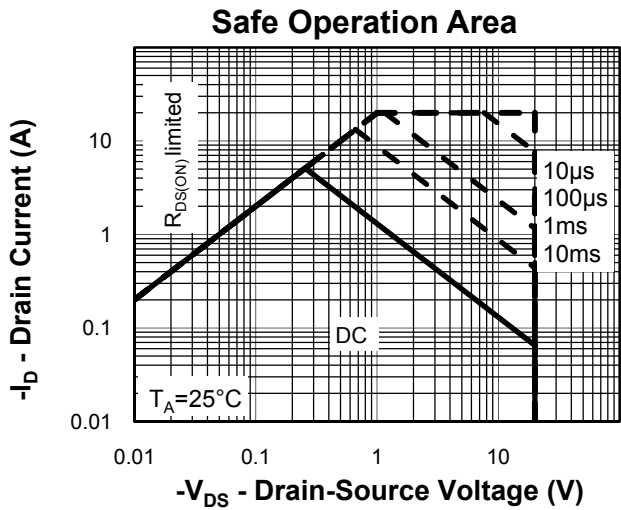
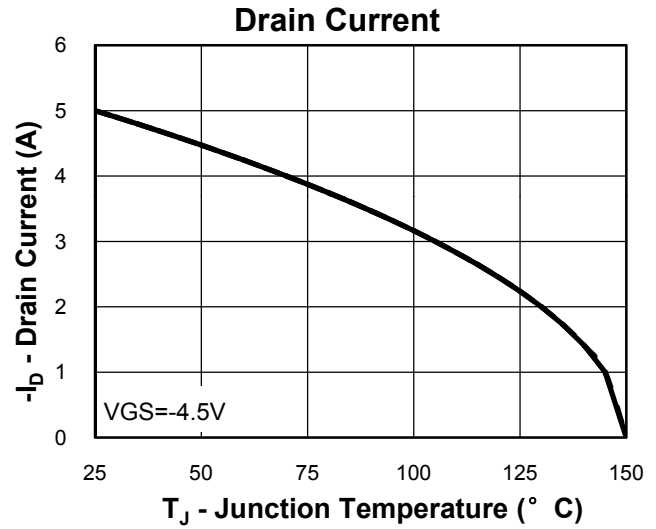
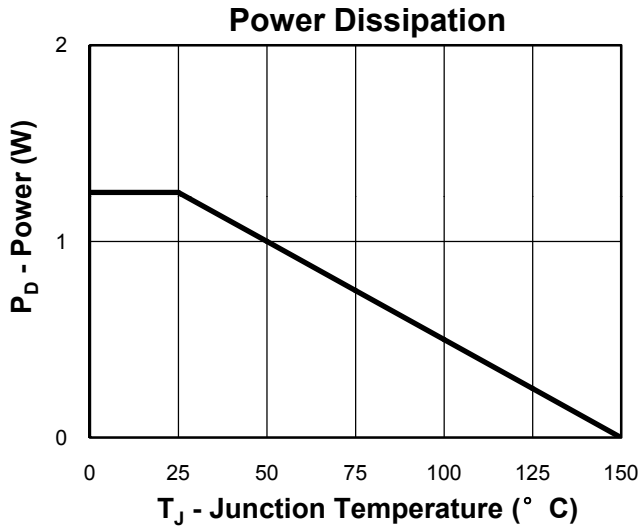

Thermal Transient Impedance

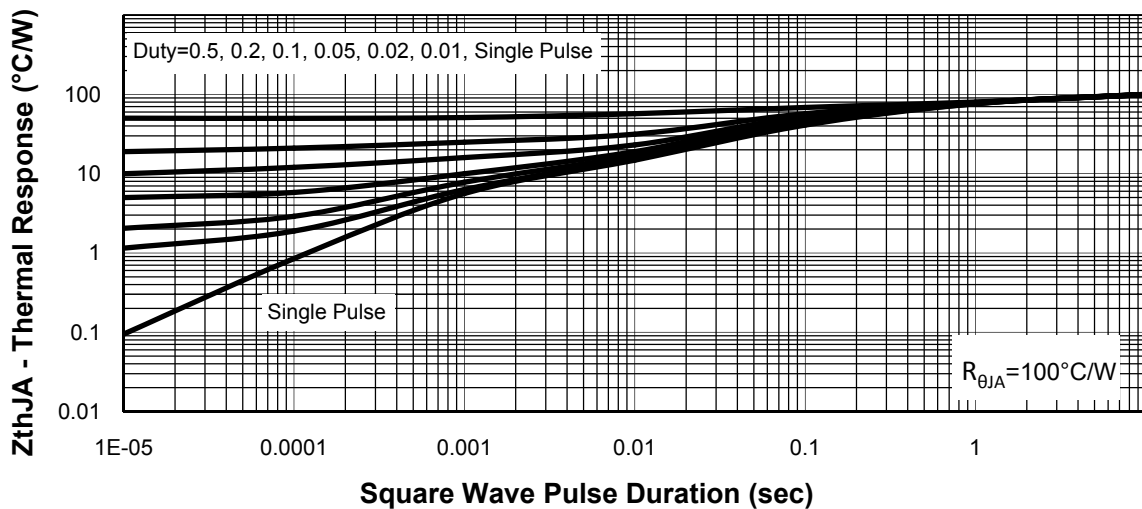

Typical Characteristics

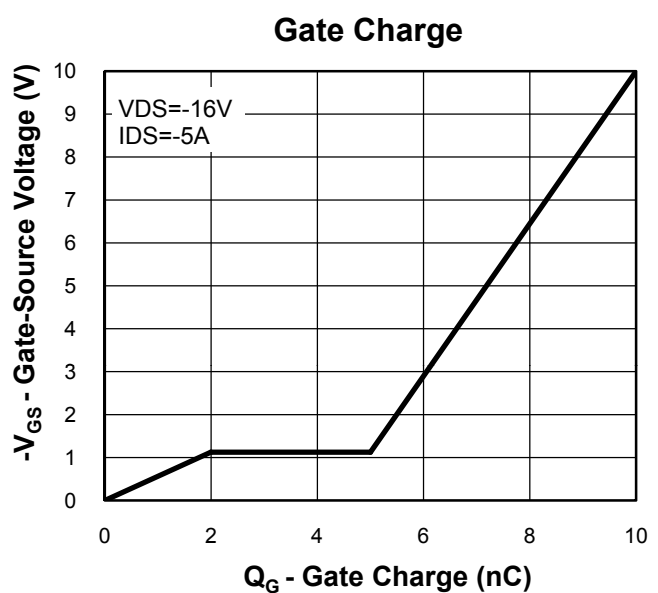
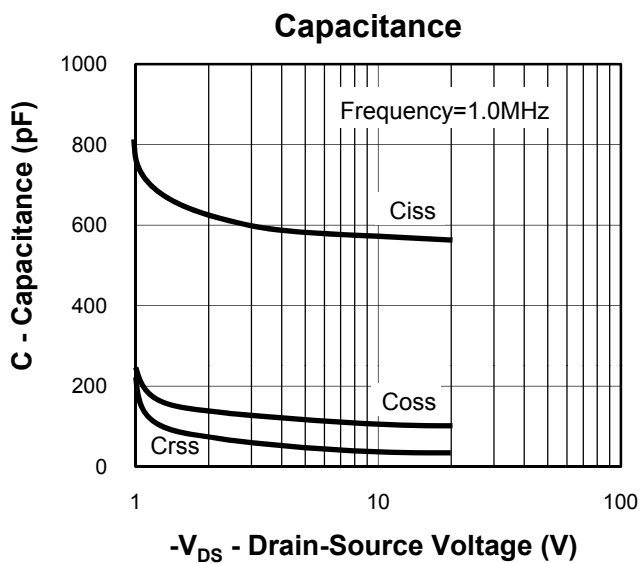
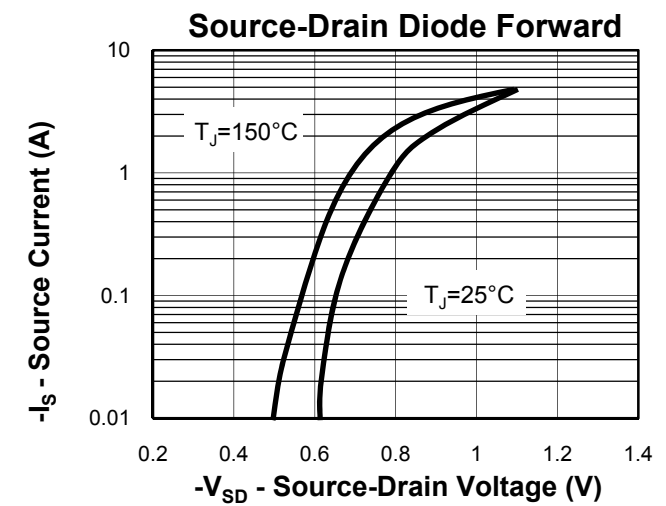
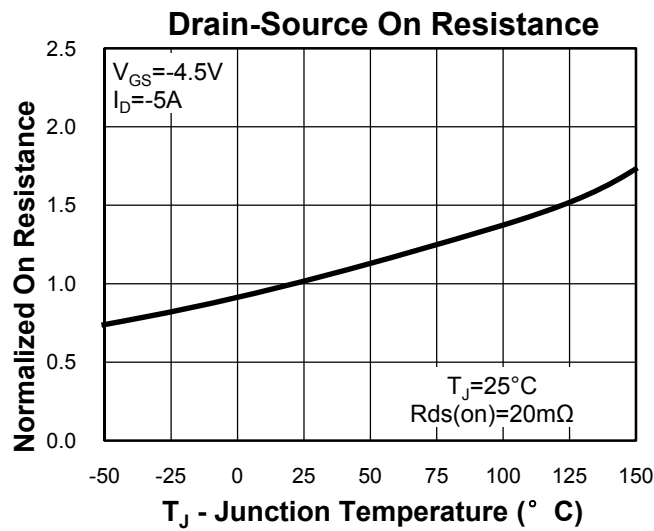
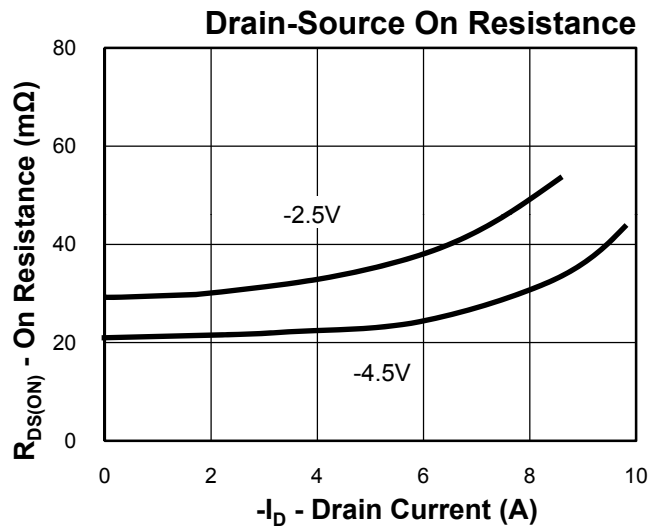
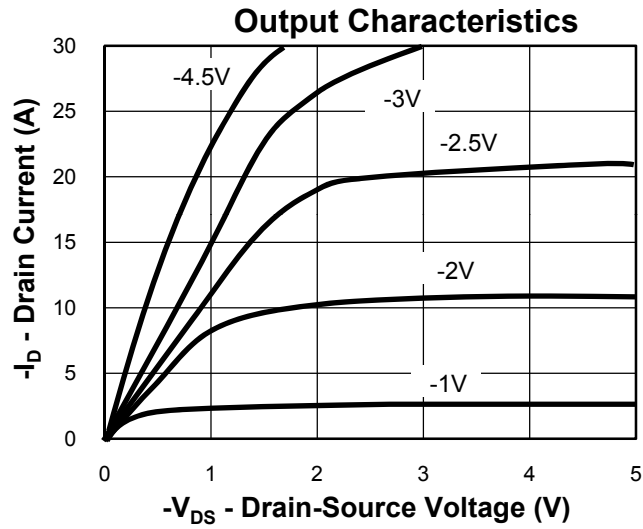

Avalanche Test Circuit and Waveforms

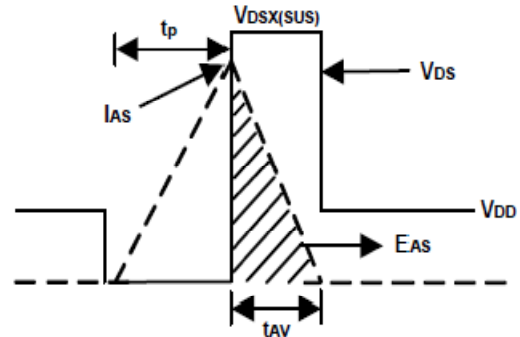
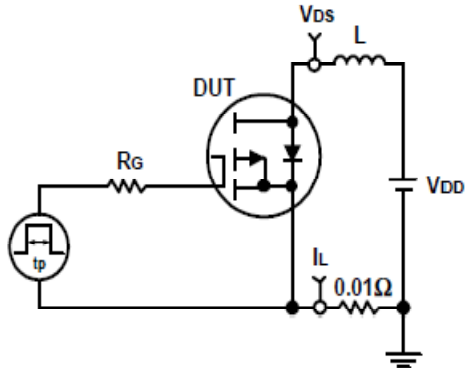

Switching Time Test Circuit and Waveforms

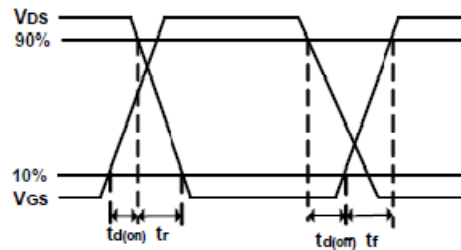
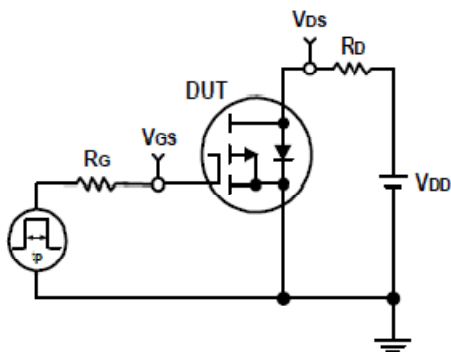

Package Information

SOT23-3

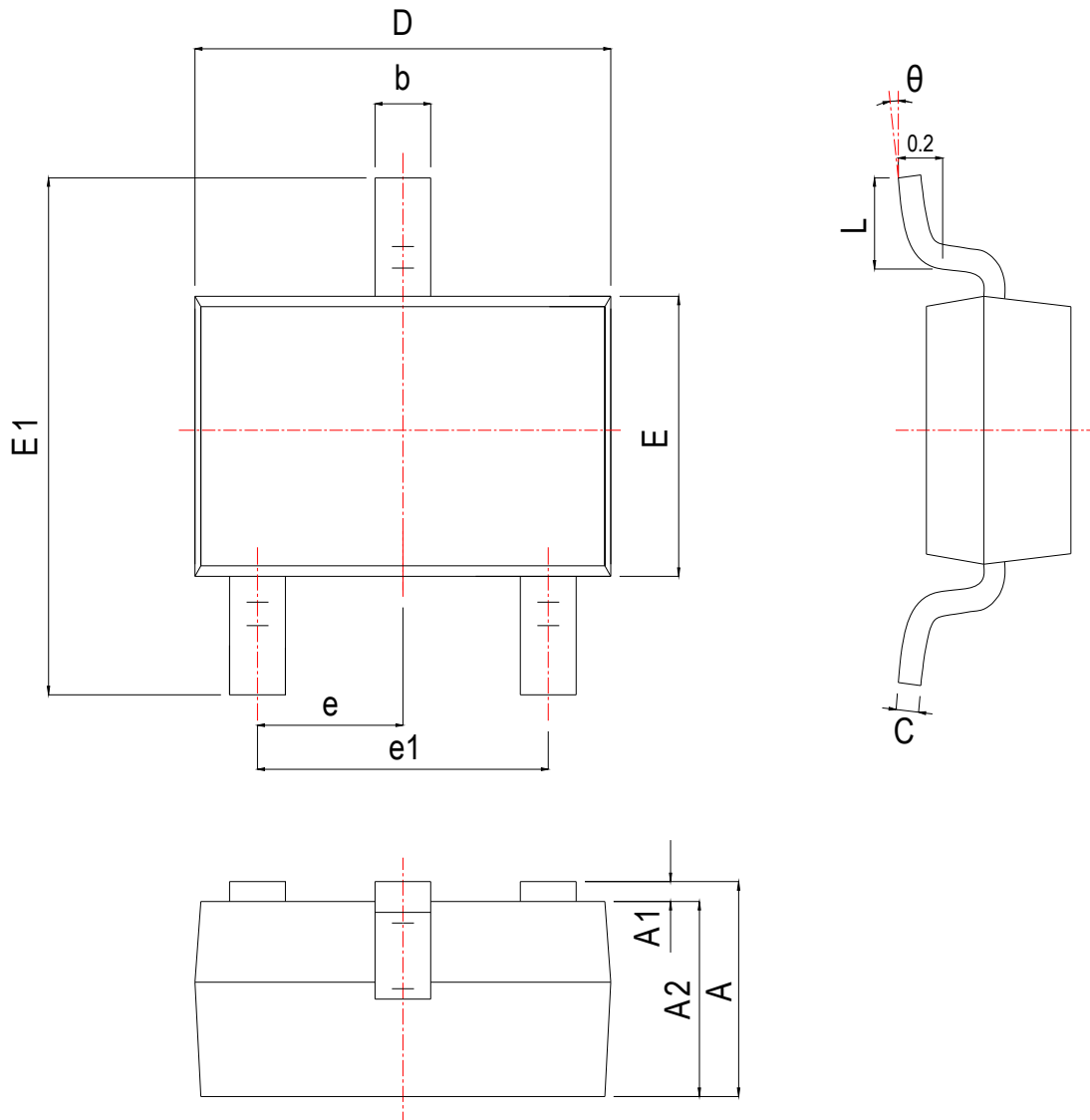

SYMBOL	MM			INCH		
	MIN	NOM	MAX	MIN	NOM	MAX
A	1.050	1.150	1.250	0.041	0.045	0.049
A1	0.000	0.050	0.100	0.000	0.002	0.004
A2	1.050	1.100	1.150	0.041	0.043	0.045
b	0.300	0.400	0.500	0.012	0.016	0.020
c	0.100	0.150	0.200	0.004	0.006	0.008
D	2.820	2.920	3.020	0.111	0.115	0.119
E	1.500	1.600	1.700	0.059	0.063	0.067
E1	2.650	2.800	2.950	0.104	0.110	0.116
e	0.950 BSC			0.037 BSC		
e1	1.800	1.900	2.000	0.071	0.075	0.079
L	0.300	0.450	0.600	0.012	0.018	0.024
θ	0°	4°	8°	0°	4°	8°

Customer Service**Worldwide Sales and Service:**

Sales@ruichips.com

Technical Support:

Technical@ruichips.com

Investor Relations Contacts:

Investor@ruichips.com

Marcom Contact:

Marcom@ruichips.com

Editorial Contact:

Editorial@ruichips.com

HR Contact:

HR@ruichips.com

Legal Contact:

Legal@ruichips.com

Shen Zhen RUICHIPS Semiconductor CO., LTD

4th Floor, Block 8, Changyuan New Material Port, Keyuan Middle Road, Science & Industry Park,
Nanshan District, Shenzhen, CHINA

TEL: (86-755) 8311-5334**FAX:** (86-755) 8311-4278**E-mail:** Sales-SZ@ruichips.com