

## TLV757P 1-A, Low $I_Q$ , Small Size, Low Dropout Regulator

### 1 Features

- Input Voltage Range: 1.45 V to 5.5 V
- Available in Fixed-Output Voltages:
  - 0.6 V to 5 V (50-mV Steps)
- Low  $I_Q$ : 25  $\mu$ A (Typical)
- Low Dropout:
  - 425 mV (Maximum) at 1 A (3.3  $V_{OUT}$ )
- Output Accuracy: 1% (Maximum)
- Built-In Soft-Start With Monotonic  $V_{OUT}$  Rise
- Foldback Current Limit
- Active Output Discharge
- High PSRR: 45 dB at 100 kHz
- Stable With a 1- $\mu$ F Ceramic Output Capacitor
- Packages:
  - SOT-23-5 (Preview)
  - 2 mm x 2 mm (WSON-6)

### 2 Applications

- Set Top Boxes, TV, and Gaming Consoles
- Portable and Battery-Powered Equipment
- Desktop, Notebooks, and Ultrabooks
- Tablets and Remote Controls
- White Goods and Appliances
- Grid Infrastructure and Protection Relays
- Camera Modules and Image Sensors

### 3 Description

The TLV757P low-dropout regulator (LDO) is an ultra-small, low quiescent current LDO that sources 1 A with good line and load transient performance. The TLV757P is optimized for wide variety of applications by supporting an input voltage range from 1.45 V to 5.5 V. To minimize cost and solution size, the device is offered in fixed output voltages ranging from 0.6 V to 5 V to support the lower core voltages of modern MCUs. Additionally, the TLV757P has a low  $I_Q$  with enable functionality to minimize standby power. This device features an internal soft-start to lower the inrush current which provides a controlled voltage to the load and minimizes the input voltage drop during start up. When shutdown, the device actively pulls down the output to quickly discharge the outputs and ensure a known start-up state.

The TLV757P is stable with small ceramic output capacitors allowing for a small overall solution size. A precision band-gap and error amplifier provides a typical accuracy of 1%. All device versions have integrated thermal shutdown, current limit, and undervoltage lockout (UVLO). The TLV757P has an internal foldback current limit that helps to reduce the thermal dissipation during short circuit events.

#### Device Information<sup>(1)</sup>

PART NUMBER	PACKAGE	BODY SIZE (NOM)
TLV757P	SON (6)	2.00 mm x 2.00 mm
	SOT-23 (5) (Preview)	2.90 mm x 1.60 mm

(1) For all available packages, see the orderable addendum at the end of the data sheet.

#### Typical Application

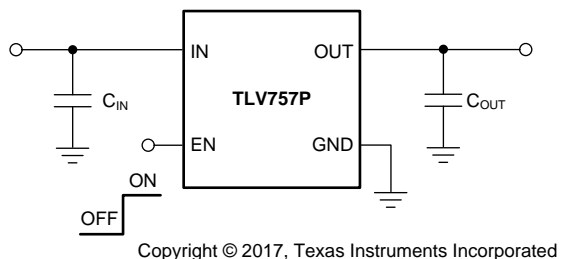

#### Startup Waveform

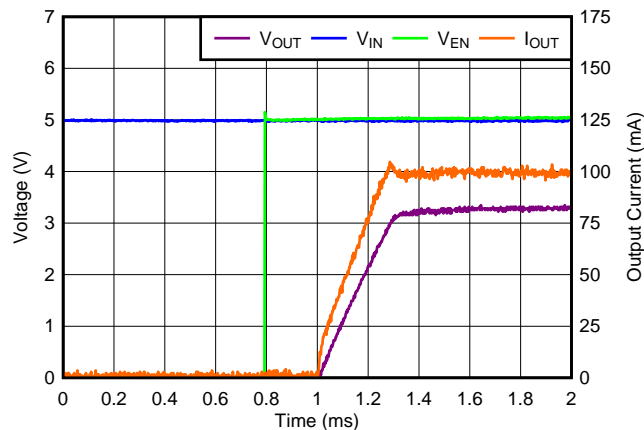

## Table of Contents

<b>1 Features</b> .....	<b>1</b>	7.4 Device Functional Modes.....	<b>14</b>
<b>2 Applications</b> .....	<b>1</b>	<b>8 Application and Implementation</b> .....	<b>15</b>
<b>3 Description</b> .....	<b>1</b>	8.1 Application Information.....	<b>15</b>
<b>4 Revision History</b> .....	<b>2</b>	8.2 Typical Application .....	<b>19</b>
<b>5 Pin Configuration and Functions</b> .....	<b>3</b>	<b>9 Power Supply Recommendations</b> .....	<b>20</b>
<b>6 Specifications</b> .....	<b>4</b>	<b>10 Layout</b> .....	<b>21</b>
6.1 Absolute Maximum Ratings .....	4	10.1 Layout Guidelines .....	21
6.2 ESD Ratings .....	4	10.2 Layout Examples.....	21
6.3 Recommended Operating Conditions.....	4	<b>11 Device and Documentation Support</b> .....	<b>22</b>
6.4 Thermal Information .....	4	11.1 Device Support.....	22
6.5 Electrical Characteristics.....	5	11.2 Receiving Notification of Documentation Updates	22
6.6 Typical Characteristics.....	7	11.3 Community Resources.....	22
<b>7 Detailed Description</b> .....	<b>12</b>	11.4 Trademarks .....	22
7.1 Overview .....	12	11.5 Electrostatic Discharge Caution.....	22
7.2 Functional Block Diagram .....	12	11.6 Glossary .....	22
7.3 Feature Description.....	12	<b>12 Mechanical, Packaging, and Orderable Information</b> .....	<b>22</b>

## 4 Revision History

NOTE: Page numbers for previous revisions may differ from page numbers in the current version.

### Changes from Original (October 2017) to Revision A

Page

• Released DRV package to production .....	<b>1</b>
--	----------

## 5 Pin Configuration and Functions

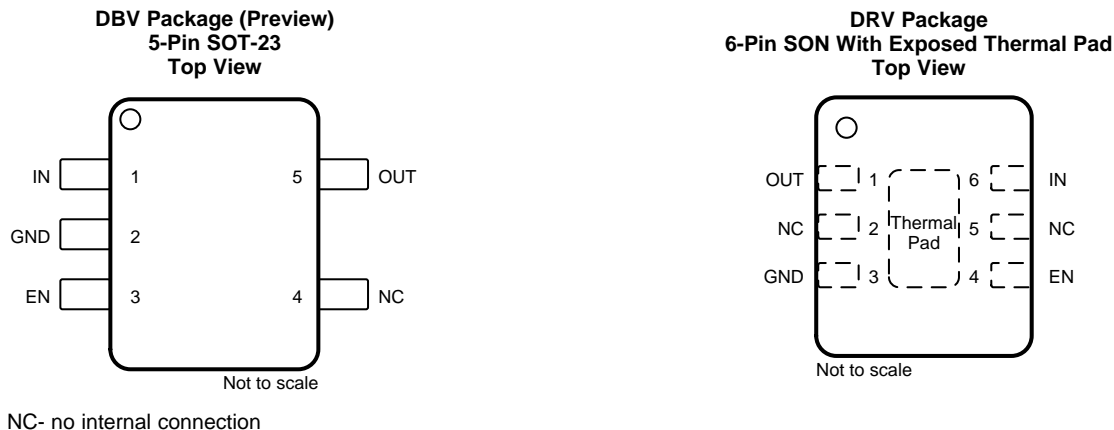

### Pin Functions

NAME	PIN		I/O	DESCRIPTION
	DBV	DRV		
EN	3	4	I	Enable pin. Drive EN greater than $V_{HI}$ to turn on the regulator. Drive EN less than $V_{LO}$ to place the LDO into shutdown mode.
GND	2	3	—	Ground pin
IN	1	6	I	Input pin. A capacitor with a value of 1 $\mu$ F or larger is required from this pin to ground <sup>(1)</sup> . See the <a href="#">Input and Output Capacitor Selection</a> section for more information.
NC	4	2, 5	—	No internal connection
OUT	5	1	O	Regulated output voltage pin. A capacitor with a value of 1 $\mu$ F or larger is required from this pin to ground <sup>(1)</sup> . See the <a href="#">Input and Output Capacitor Selection</a> section for more information.
Thermal pad	—	Pad	—	Connect the thermal pad to a large-area ground plane. The thermal pad is internally connected to GND.

(1) The nominal input and output capacitance must be greater than 0.47  $\mu$ F; throughout this document the nominal derating on these capacitors is 50%. Take care to ensure that the effective capacitance at the pin is greater than 0.47  $\mu$ F.

## 6 Specifications

### 6.1 Absolute Maximum Ratings

over operating free-air temperature range (unless otherwise noted)<sup>(1)</sup>

	MIN	MAX	UNIT
Supply voltage, $V_{IN}$	-0.3	6	V
Enable voltage, $V_{EN}$	-0.3	6	V
Output voltage, $V_{OUT}$	-0.3	$V_{IN} + 0.3$ <sup>(2)</sup>	V
Operating junction temperature range, $T_J$	-40	150	°C
Storage temperature, $T_{stg}$	-65	150	°C

- (1) Stresses beyond those listed under *Absolute Maximum Ratings* may cause permanent damage to the device. These are stress ratings only, which do not imply functional operation of the device at these or any other conditions beyond those indicated under *Recommended Operating Conditions*. Exposure to absolute-maximum-rated conditions for extended periods may affect device reliability.
- (2) The absolute maximum rating is  $V_{IN} + 0.3$  V or 6 V, whichever is smaller

### 6.2 ESD Ratings

		VALUE	UNIT
$V_{(ESD)}$ Electrostatic discharge	Human-body model (HBM), per ANSI/ESDA/JEDEC JS-001 <sup>(1)</sup>	±1000	V
	Charged-device model (CDM), per JEDEC specification JESD22-C101 <sup>(2)</sup>	±500	

- (1) JEDEC document JEP155 states that 500-V HBM allows safe manufacturing with a standard ESD control process. Manufacturing with less than 500-V HBM is possible with the necessary precautions.
- (2) JEDEC document JEP157 states that 250-V CDM allows safe manufacturing with a standard ESD control process. Manufacturing with less than 250-V CDM is possible with the necessary precautions.

### 6.3 Recommended Operating Conditions

over operating free-air temperature range (unless otherwise noted)

		MIN	NOM	MAX	UNIT
$V_{IN}$	Input voltage	1.45		5.5	V
$V_{OUT}$	Output voltage	0.6		5	V
$V_{EN}$	Enable voltage	0		5.5	V
$I_{OUT}$	Output current	0		1	A
$C_{IN}$	Input capacitor	1			µF
$C_{OUT}$	Output capacitor	1		200	µF
$f_{EN}$	Enable toggle frequency			10	kHz
$T_J$	Junction temperature	-40		125	°C

### 6.4 Thermal Information

THERMAL METRIC <sup>(1)</sup>		TLV757		UNIT
		DBV (SOT-23)	DRV (SON)	
		5 PINS	6 PINS	
$R_{\theta JA}$	Junction-to-ambient thermal resistance	231.1	100.2	°C/W
$R_{\theta JC(top)}$	Junction-to-case (top) thermal resistance	118.4	108.5	°C/W
$R_{\theta JB}$	Junction-to-board thermal resistance	64.4	64.3	°C/W
$\Psi_{JT}$	Junction-to-top characterization parameter	28.4	10.4	°C/W
$\Psi_{JB}$	Junction-to-board characterization parameter	63.8	64.8	°C/W
$R_{\theta JC(bot)}$	Junction-to-case (bottom) thermal resistance	N/A	34.7	°C/W

- (1) For more information about traditional and new thermal metrics, see the [Semiconductor and IC Package Thermal Metrics](#) application report.

## 6.5 Electrical Characteristics

over operating free-air temperature range ( $T_J = -40^\circ\text{C}$  to  $+125^\circ\text{C}$ ),  $V_{IN} = V_{OUT} + 0.5\text{ V}$  or  $1.45\text{ V}$  (whichever is greater),  $I_{OUT} = 1\text{ mA}$ ,  $V_{EN} = V_{IN}$ , and  $C_{IN} = C_{OUT} = 1\text{ }\mu\text{F}$  (unless otherwise noted); all typical values are at  $T_J = 25^\circ\text{C}$ .

PARAMETER	TEST CONDITIONS	MIN	TYP	MAX	UNIT		
$V_{IN}$	Input voltage	1.45		5.5	V		
$V_{OUT}$	Output voltage	0.6		5	V		
Output accuracy	$-40^\circ\text{C} \leq T_J \leq 85^\circ\text{C}$ , $V_{OUT} \geq 1\text{ V}$	-1%		1%			
	$-40^\circ\text{C} \leq T_J \leq 85^\circ\text{C}$ , $0.6\text{ V} \leq V_{OUT} < 1\text{ V}$	-10		10	mV		
	$V_{OUT} \geq 1\text{ V}$	-1.5%		1.5%			
	$0.6\text{ V} \leq V_{OUT} < 1\text{ V}$	-15		15	mV		
$(\Delta V_{OUT})/\Delta V_{IN}$	Line regulation $V_{OUT} + 0.5\text{ V}^{(1)} \leq V_{IN} \leq 5.5\text{ V}$		2		mV		
$\Delta V_{OUT}/\Delta I_{OUT}$ T	Load regulation $0.1\text{ mA} \leq I_{OUT} \leq 1\text{ A}$ , $V_{IN} \geq 2.4\text{ V}$	DRV package	0.044		V/A		
		DBV package	0.060				
$I_{GND}$	Ground current $T_J = 25^\circ\text{C}$		25	31	$\mu\text{A}$		
		$-40^\circ\text{C} \leq T_J \leq +85^\circ\text{C}$		33			
		$-40^\circ\text{C} \leq T_J \leq +125^\circ\text{C}$		40			
$I_{SHDN}$	Shutdown current $V_{EN} \leq 0.4\text{ V}$ , $1.45\text{ V} \leq V_{IN} \leq 5.5\text{ V}$ , $-40^\circ\text{C} \leq T_J \leq +125^\circ\text{C}$		0.1	1	$\mu\text{A}$		
$I_{CL}$	Output current limit $V_{IN} = V_{OUT} + V_{DO(MAX)} + 0.25\text{ V}$	$V_{OUT} = V_{OUT} - 0.2\text{ V}$ , $V_{OUT} \leq 1.5\text{ V}$	1.2	1.55	1.78	A	
		$V_{OUT} = 0.9 \times V_{OUT}$ , $1.5\text{ V} < V_{OUT} \leq 4.5\text{ V}$					
$I_{SC}$	Short circuit current limit $V_{OUT} = 0\text{ V}$ , $V_{IN} = V_{OUT} + V_{DO(MAX)} + 0.25\text{ V}$		755		mA		
$V_{DO}$	Dropout voltage $I_{OUT} = 1\text{ A}$ , $-40^\circ\text{C} \leq T_J \leq +85^\circ\text{C}$	$0.6\text{ V} \leq V_{OUT} < 0.8\text{ V}$		1350	1400	mV	
		$0.8\text{ V} \leq V_{OUT} < 1\text{ V}$		1200	1300	mV	
		$1\text{ V} \leq V_{OUT} < 1.2\text{ V}$		1100	1150	mV	
		$1.2\text{ V} \leq V_{OUT} < 1.5\text{ V}$		1000	1050	mV	
		$1.5\text{ V} \leq V_{OUT} < 1.8\text{ V}$		700	800	mV	
		$1.8\text{ V} \leq V_{OUT} < 2.5\text{ V}$		650	750	mV	
		$2.5\text{ V} \leq V_{OUT} < 3.3\text{ V}$		500	600	mV	
		$3.3\text{ V} \leq V_{OUT} < 5.0\text{ V}$		300	425	mV	
		$I_{OUT} = 1\text{ A}$ , $-40^\circ\text{C} \leq T_J \leq +125^\circ\text{C}$	$0.6\text{ V} \leq V_{OUT} < 0.8\text{ V}$			1450	mV
			$0.8\text{ V} \leq V_{OUT} < 1\text{ V}$			1350	mV
			$1\text{ V} \leq V_{OUT} < 1.2\text{ V}$			1200	mV
			$1.2\text{ V} \leq V_{OUT} < 1.5\text{ V}$			1100	mV
			$1.5\text{ V} \leq V_{OUT} < 1.8\text{ V}$			850	mV
			$1.8\text{ V} \leq V_{OUT} < 2.5\text{ V}$			800	mV
			$2.5\text{ V} \leq V_{OUT} < 3.3\text{ V}$			650	mV
			$3.3\text{ V} \leq V_{OUT} < 5.0\text{ V}$			475	mV
PSRR	Power supply rejection ratio $f = 1\text{ kHz}$ , $V_{IN} = V_{OUT} + 1\text{ V}$ , $I_{OUT} = 50\text{ mA}$		52		dB		
		$f = 100\text{ kHz}$ , $V_{IN} = V_{OUT} + 1\text{ V}$ , $I_{OUT} = 50\text{ mA}$	46				
		$f = 1\text{ MHz}$ , $V_{IN} = V_{OUT} + 1\text{ V}$ , $I_{OUT} = 50\text{ mA}$	52				
$V_n$	Output noise voltage $BW = 10\text{ Hz to } 100\text{ kHz}$ , $V_{OUT} = 1.2\text{ V}$ , $I_{OUT} = 1\text{ A}$		71.5		$\mu\text{V}_{RMS}$		
$V_{UVLO}$	Undervoltage lockout $V_{IN}$ rising	1.21	1.3	1.44	V		
$V_{UVLO, HYST}$	Undervoltage lockout hysteresis $V_{IN}$ falling		40		mV		
$t_{STR}$	Startup time		550		$\mu\text{s}$		
$V_{HI}$	EN pin high voltage (enabled)	1			V		

(1)  $V_{IN} = 1.45\text{ V}$  for  $V_{OUT} < 0.9\text{ V}$

**Electrical Characteristics (continued)**

over operating free-air temperature range ( $T_J = -40^{\circ}\text{C}$  to  $+125^{\circ}\text{C}$ ),  $V_{IN} = V_{OUT} + 0.5\text{ V}$  or  $1.45\text{ V}$  (whichever is greater),  $I_{OUT} = 1\text{ mA}$ ,  $V_{EN} = V_{IN}$ , and  $C_{IN} = C_{OUT} = 1\text{ }\mu\text{F}$  (unless otherwise noted); all typical values are at  $T_J = 25^{\circ}\text{C}$ .

PARAMETER		TEST CONDITIONS	MIN	TYP	MAX	UNIT
$V_{LO}$	EN pin low voltage (enabled)				0.3	V
$I_{EN}$	Enable pin current	$V_{IN} = 5.5\text{ V}$ , $EN = 5.5\text{ V}$		10		nA
$R_{PULLDOWN}$	Pulldown resistance	$V_{IN} = 3.3\text{ V}$ (P version only)		95		$\Omega$
$T_{SD}$	Thermal shutdown	Shutdown, temperature increasing		165		$^{\circ}\text{C}$
		Reset, temperature decreasing		155		$^{\circ}\text{C}$

### 6.6 Typical Characteristics

at operating temperature  $T_J = 25^\circ\text{C}$ ,  $V_{IN} = V_{OUT(NOM)} + 0.5\text{ V}$  or  $1.45\text{ V}$  (whichever is greater),  $I_{OUT} = 1\text{ mA}$ ,  $V_{EN} = V_{IN}$ , and  $C_{IN} = C_{OUT} = 1\ \mu\text{F}$  (unless otherwise noted)

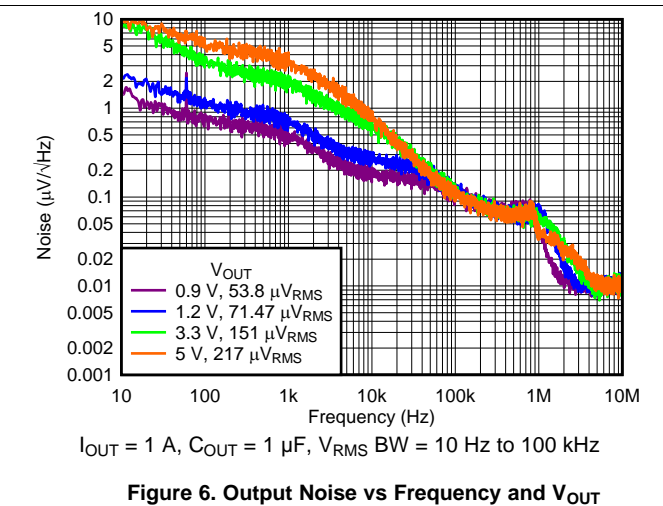
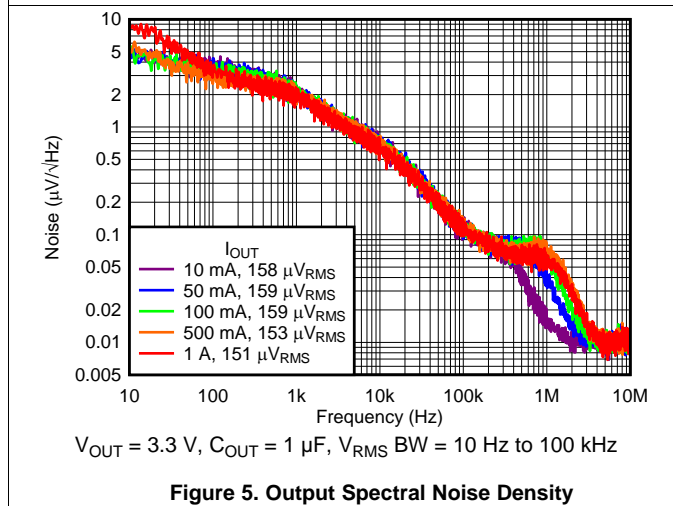
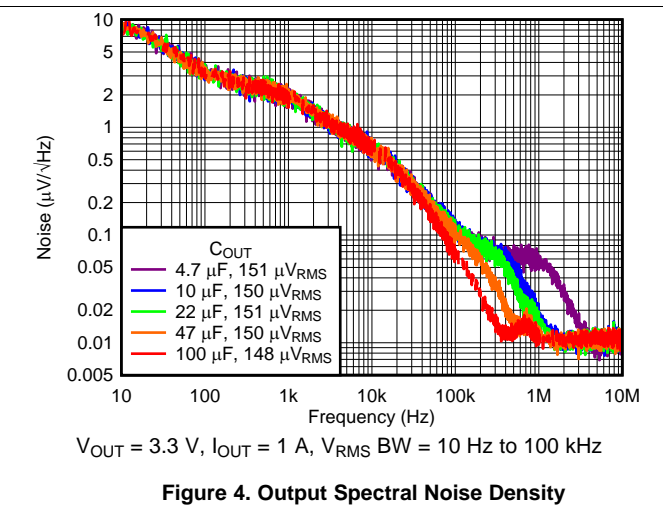
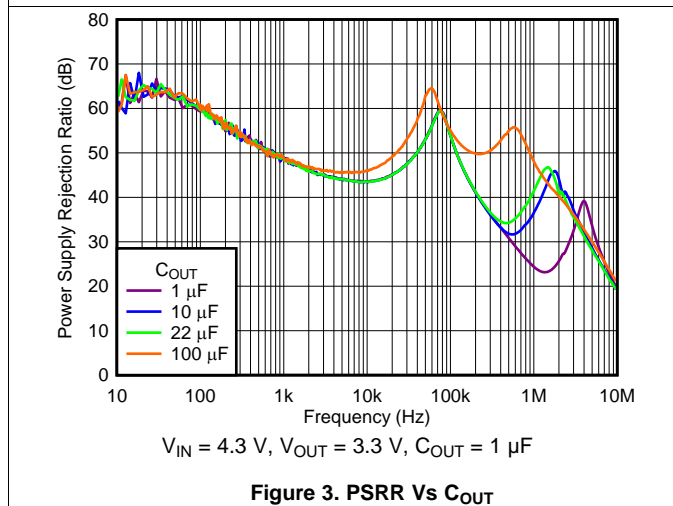
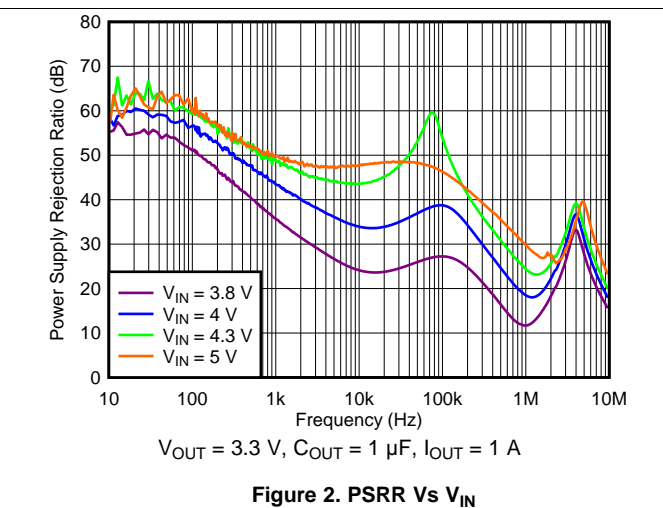
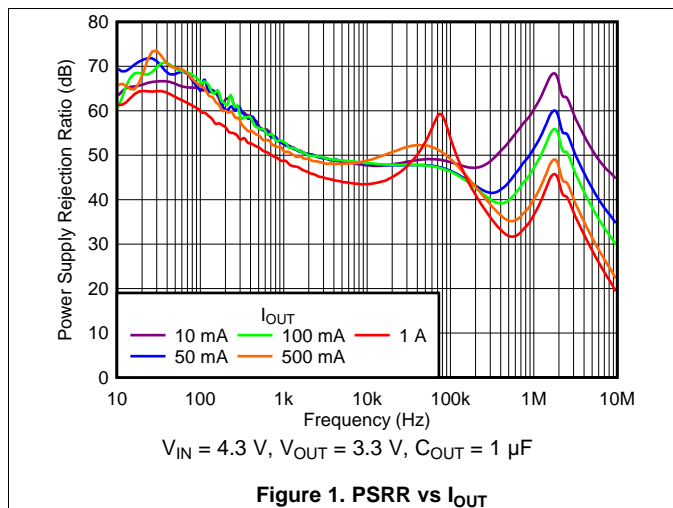

**Typical Characteristics (continued)**

at operating temperature  $T_J = 25^\circ\text{C}$ ,  $V_{IN} = V_{OUT(NOM)} + 0.5\text{ V}$  or  $1.45\text{ V}$  (whichever is greater),  $I_{OUT} = 1\text{ mA}$ ,  $V_{EN} = V_{IN}$ , and  $C_{IN} = C_{OUT} = 1\text{ }\mu\text{F}$  (unless otherwise noted)

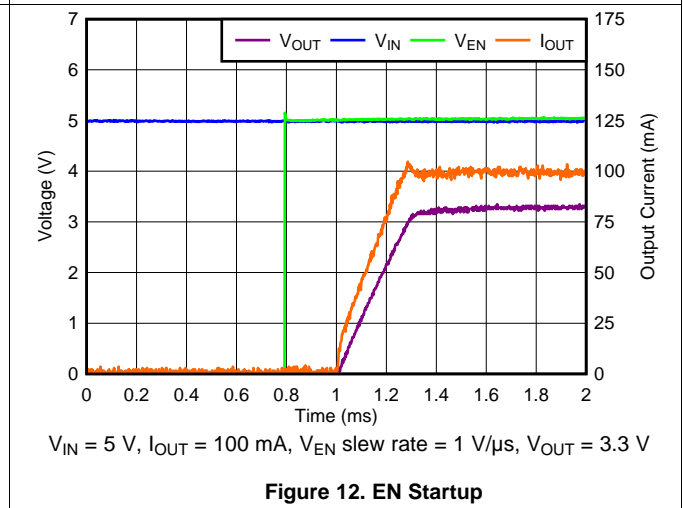
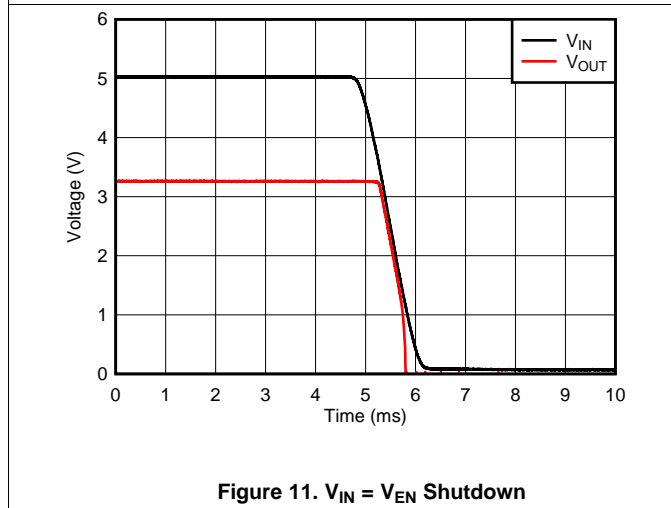
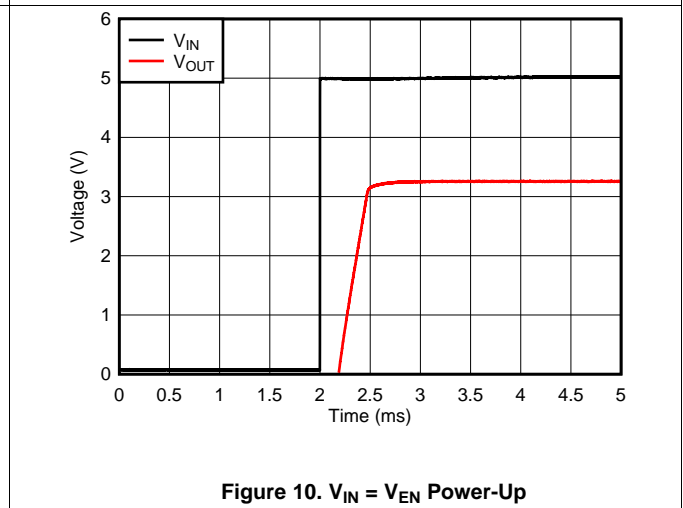
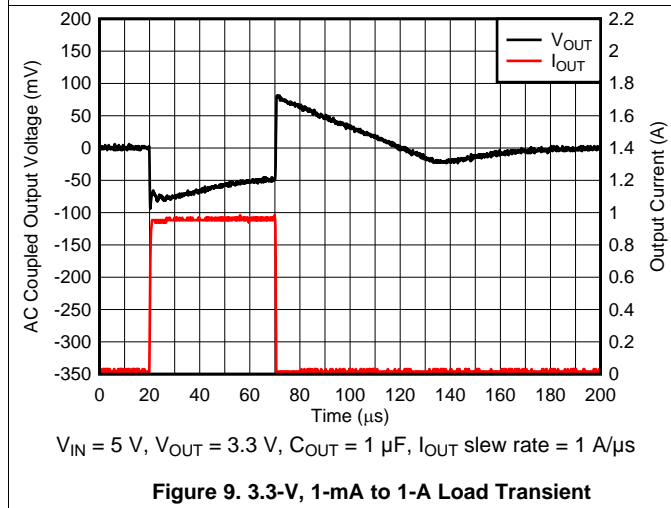
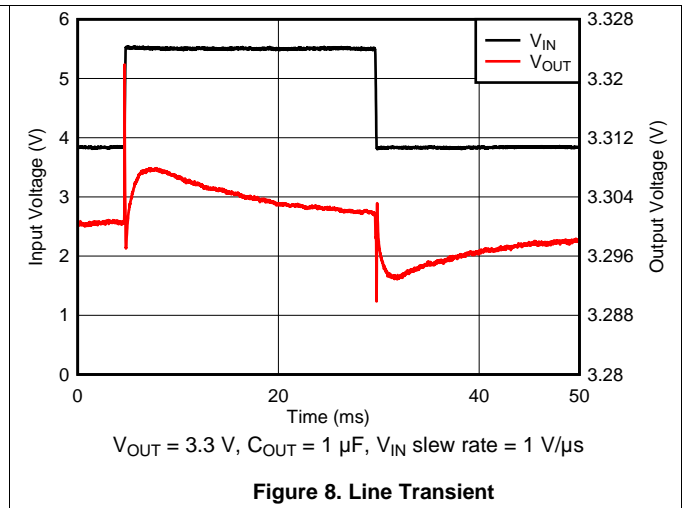
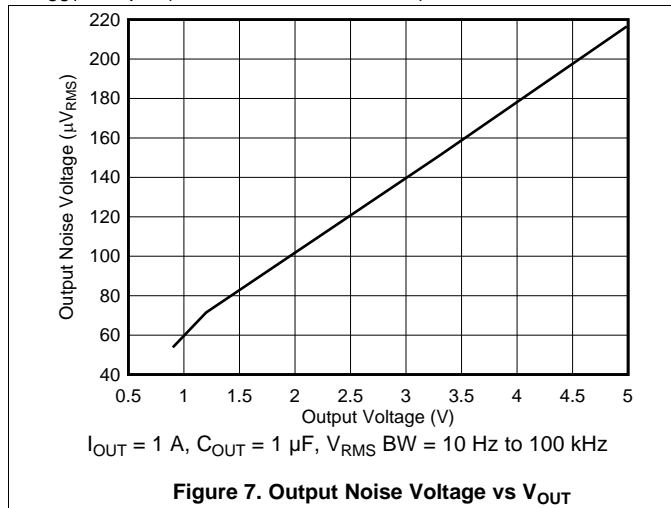



Typical Characteristics (continued)

at operating temperature  $T_J = 25^\circ\text{C}$ ,  $V_{IN} = V_{OUT(NOM)} + 0.5\text{ V}$  or  $1.45\text{ V}$  (whichever is greater),  $I_{OUT} = 1\text{ mA}$ ,  $V_{EN} = V_{IN}$ , and  $C_{IN} = C_{OUT} = 1\text{ }\mu\text{F}$  (unless otherwise noted)

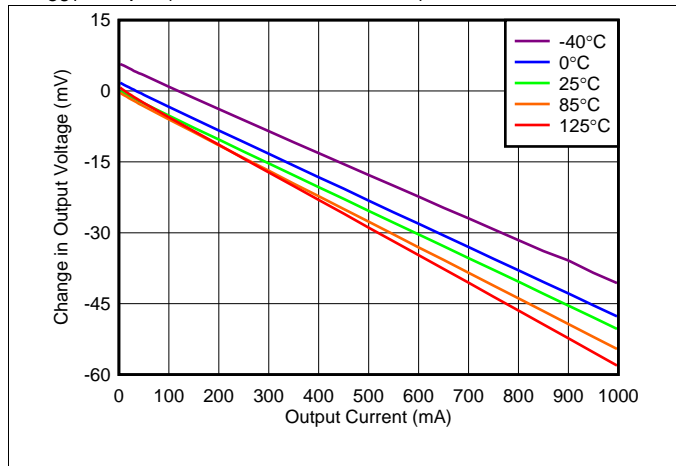

Figure 13. Load Regulation vs  $I_{OUT}$

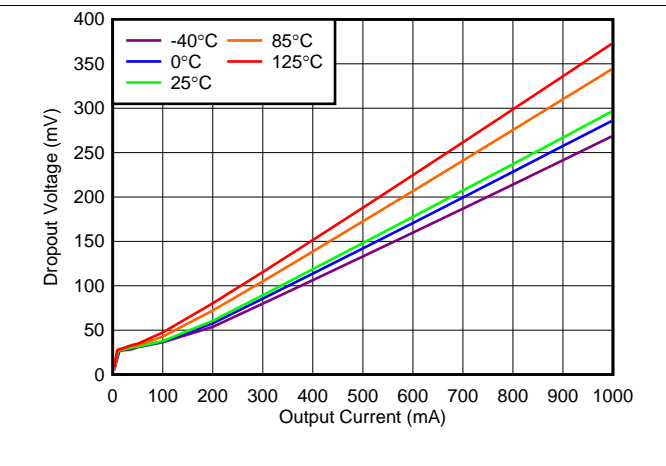

Figure 14. 3.3-V Dropout Voltage vs  $I_{OUT}$

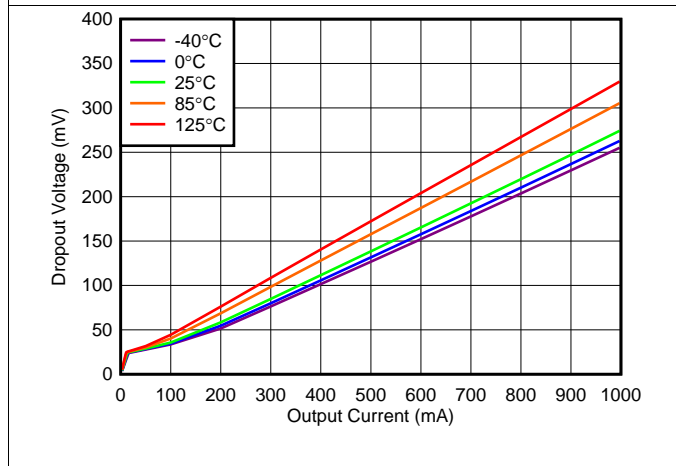

Figure 15. 5.0-V Dropout Voltage vs  $I_{OUT}$

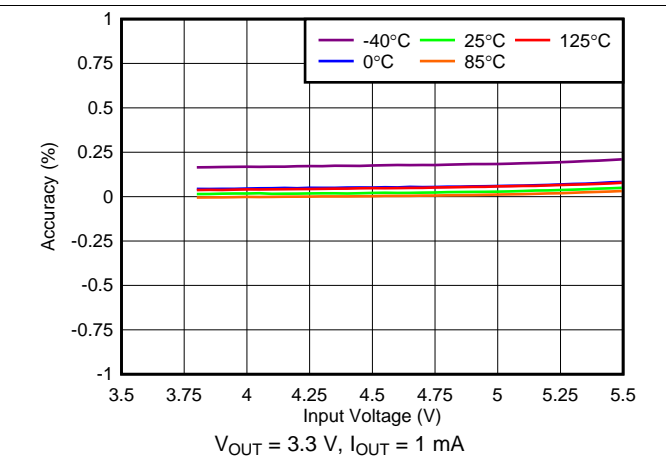

Figure 16. 3.3 V Regulation vs  $V_{IN}$  (Line Regulation)

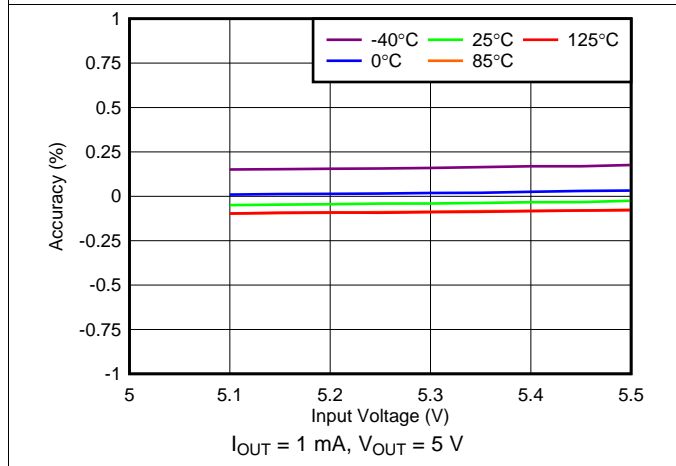

Figure 17. 5.0-V Accuracy vs  $V_{IN}$  (Line Regulation)

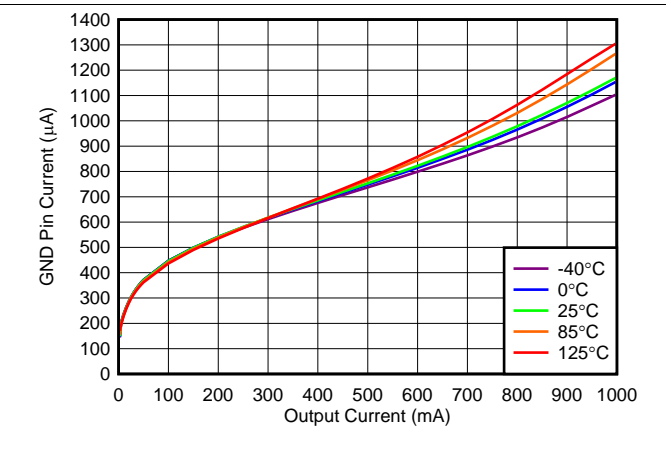

Figure 18.  $I_{GND}$  vs  $I_{OUT}$

**Typical Characteristics (continued)**

at operating temperature  $T_J = 25^\circ\text{C}$ ,  $V_{IN} = V_{OUT(NOM)} + 0.5\text{ V}$  or  $1.45\text{ V}$  (whichever is greater),  $I_{OUT} = 1\text{ mA}$ ,  $V_{EN} = V_{IN}$ , and  $C_{IN} = C_{OUT} = 1\text{ }\mu\text{F}$  (unless otherwise noted)

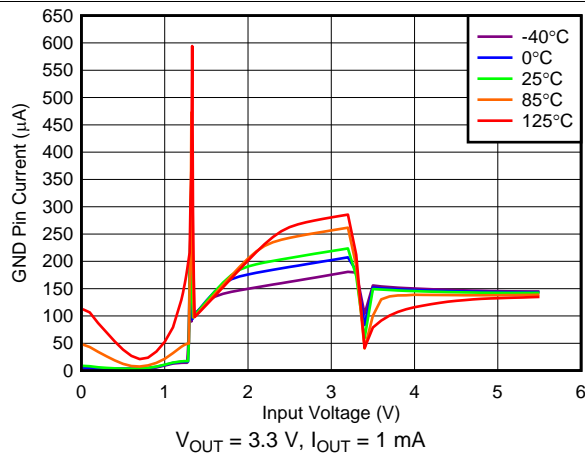

Figure 19.  $I_{GND}$  vs  $V_{IN}$

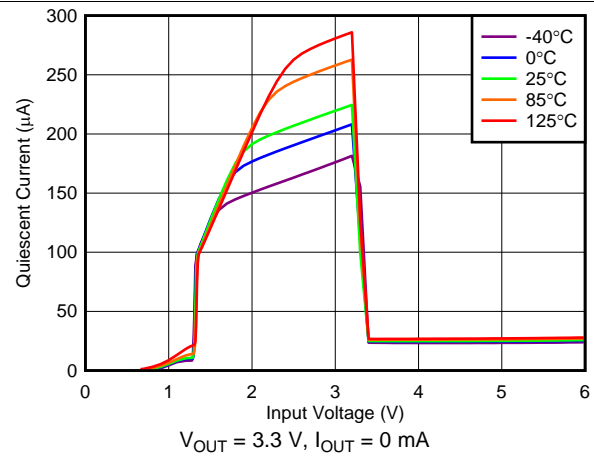

Figure 20.  $I_{GND}$  vs  $V_{IN}$

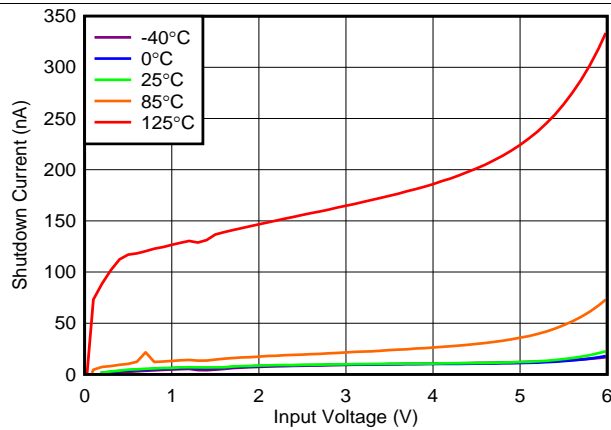

Figure 21.  $I_{SHDN}$  vs  $V_{IN}$

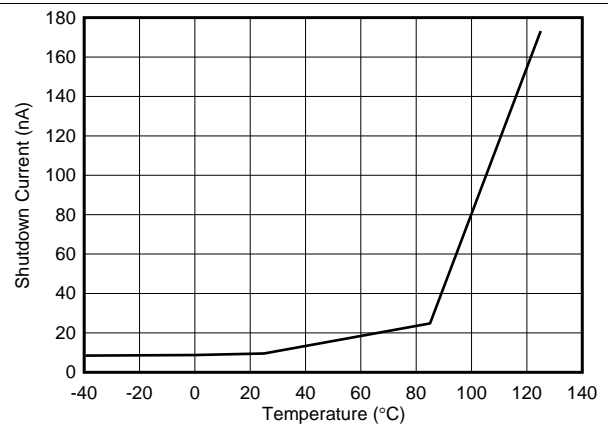

Figure 22.  $I_{SHDN}$  vs Temperature

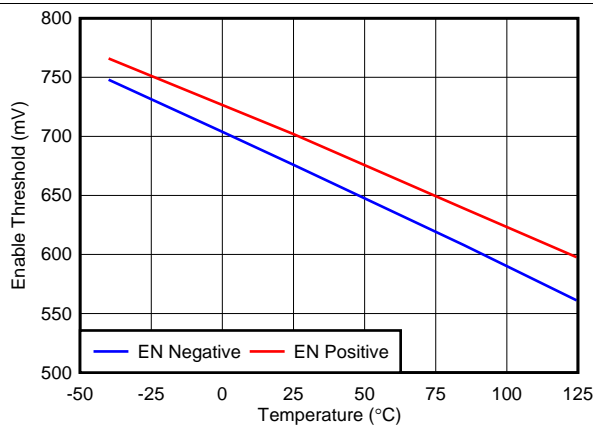

Figure 23. Enable Threshold vs Temperature

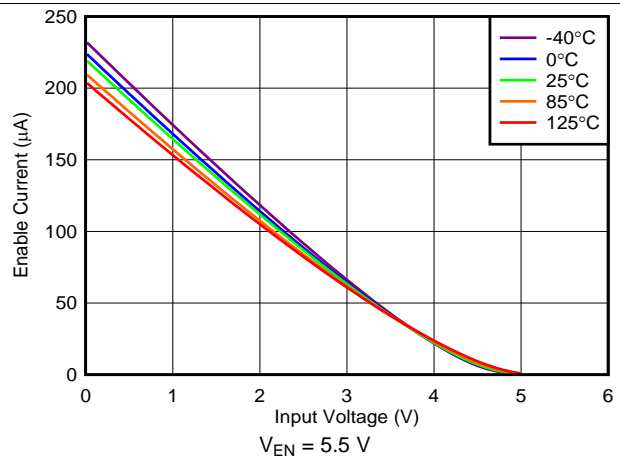

Figure 24.  $I_{EN}$  vs  $V_{IN}$

Typical Characteristics (continued)

at operating temperature  $T_J = 25^\circ\text{C}$ ,  $V_{IN} = V_{OUT(NOM)} + 0.5\text{ V}$  or  $1.45\text{ V}$  (whichever is greater),  $I_{OUT} = 1\text{ mA}$ ,  $V_{EN} = V_{IN}$ , and  $C_{IN} = C_{OUT} = 1\ \mu\text{F}$  (unless otherwise noted)

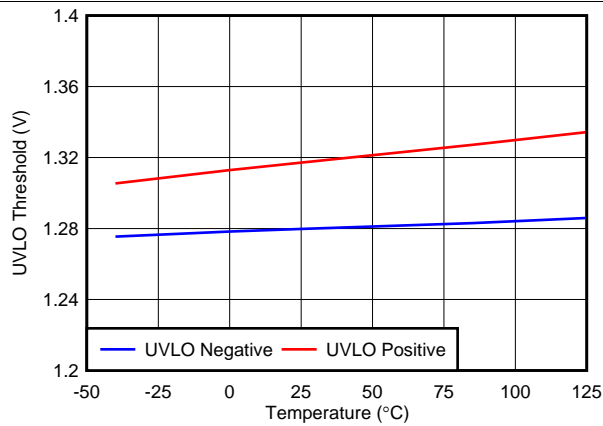

Figure 25. UVLO Threshold vs Temperature

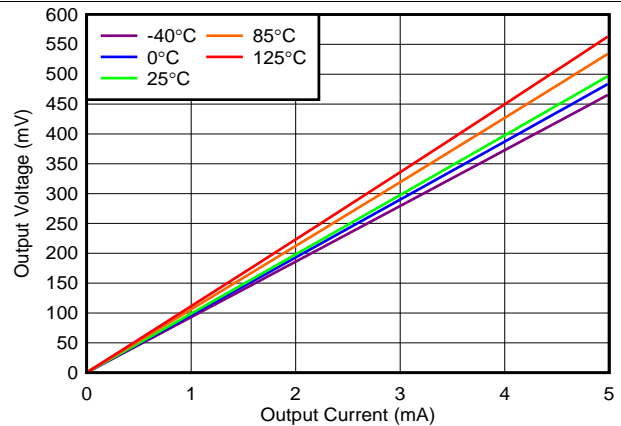

Figure 26.  $I_{OUT}$  vs  $V_{OUT}$  Pulldown Resistor

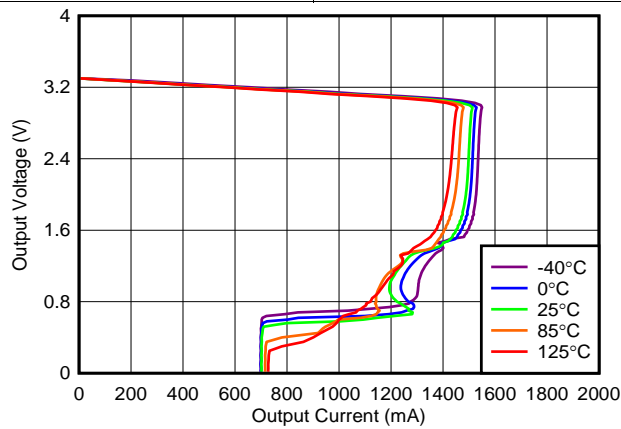

Figure 27. 3.3-V Foldback Current Limit vs  $I_{OUT}$

## 7 Detailed Description

### 7.1 Overview

The TLV757P belongs to a family of next-generation, low-dropout regulators (LDOs). This device consumes low quiescent current and delivers excellent line and load transient performance. The TLV757P is optimized for wide variety of applications by supporting an input voltage range from 1.4 V to 5.5 V. To minimize cost and solution size, the device is offered in fixed output voltages ranging from 0.6 V to 5 V to support the lower core voltages of modern microcontrollers (MCUs).

This regulator offers foldback current limit, shutdown, and thermal protection. The operating junction temperature is  $-40^{\circ}\text{C}$  to  $+125^{\circ}\text{C}$ .

### 7.2 Functional Block Diagram

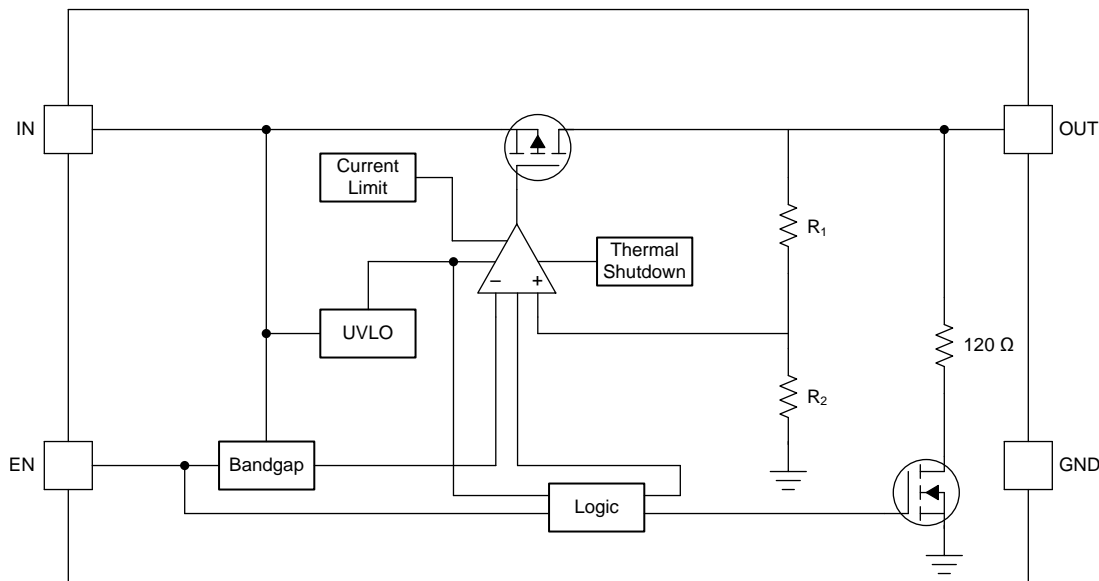

(1)  $R_2 = 550\text{ k}\Omega$ ,  $R_1 = \text{adjustable}$ .

### 7.3 Feature Description

#### 7.3.1 Undervoltage Lockout (UVLO)

An undervoltage lockout (UVLO) circuit disables the output until the input voltage is greater than the rising UVLO voltage ( $V_{UVLO}$ ). This circuit ensures that the device does not exhibit any unpredictable behavior when the supply voltage is lower than the operational range of the internal circuitry. When  $V_{IN}$  is less than  $V_{UVLO}$ , the output is connected to ground with a  $120\text{-}\Omega$  pull-down resistor.

#### 7.3.2 Enable (EN)

The enable pin (EN) is active high. Enable the device by forcing the EN pin to exceed  $V_{HI}$ . Turn off the device by forcing the EN pin below  $V_{LO}$ . If shutdown capability is not required, connect EN to IN.

The device has an internal pull-down that connects a  $120\text{-}\Omega$  resistor to ground when the device is disabled. The discharge time after disabling depends on the output capacitance ( $C_{OUT}$ ) and the load resistance ( $R_L$ ) in parallel with the  $120\text{-}\Omega$  pull-down resistor. Equation 1 calculates the time constant  $\tau$ :

$$\tau = \frac{120 \cdot R_L}{120 + R_L} \cdot C_{OUT} \quad (1)$$

## Feature Description (continued)

The EN pin is independent of the input pin, but if the EN pin is driven to a higher voltage than  $V_{IN}$ , the current into the EN pin increases. This effect is illustrated in [Figure 24](#). When the EN voltage is higher than the input voltage there is an increased current flow into the EN pin. If this increased flow causes problems in the application, sequence the EN pin after  $V_{IN}$  is high, or to tie EN to  $V_{IN}$  to prevent this flow increase from happening. If EN is driven to a higher voltage than  $V_{IN}$ , limit the frequency on EN to below 10 kHz.

### 7.3.3 Internal Foldback Current Limit

The TLV757P has an internal current limit that protects the regulator during fault conditions. The current limit is a hybrid scheme with brick wall until the output voltage is less than  $0.4 \times V_{OUT(NOM)}$ . When the voltage drops below  $0.4 \times V_{OUT(NOM)}$ , a foldback current limit is implemented which scales back the current as the output voltage approaches GND. When the output shorts, the LDO supplies a typical current of  $I_{SC}$ . The output voltage is not regulated when the device is in current limit. In this condition, the output voltage is the product of the regulated current and the load resistance. When the device output is shorts, the PMOS pass transistor dissipates power  $[(V_{IN} - V_{OUT}) \times I_{SC}]$  until thermal shutdown is triggered and the device turns off. After the device cools down, the internal thermal shutdown circuit turns the device back on. If the fault condition continues, the device cycles between current limit and thermal shutdown.

The foldback current-limit circuit limits the current that is allowed through the device to current levels lower than the minimum current limit at nominal  $V_{OUT}$  current limit ( $I_{CL}$ ) during start up. See [Figure 27](#) for typical current limit values. If the output is loaded by a constant-current load during start up, or if the output voltage is negative when the device is enabled, then the load current demanded by the load may exceed the foldback current limit and the device may not rise to the full output voltage. For constant-current loads, disable the output load until the output has risen to the nominal voltage.

Excess inductance can cause the current limit to oscillate. Minimize the inductance to keep the current limit from oscillating during a fault condition.

### 7.3.4 Thermal Shutdown

Thermal shutdown protection disables the output when the junction temperature rises to approximately 165°C. Disabling the device eliminates the power dissipated by the device, allowing the device to cool. When the junction temperature cools to approximately 155°C, the output circuitry is enabled again. Depending on power dissipation, thermal resistance, and ambient temperature, the thermal protection circuit may cycle on and off. This cycling limits regulator dissipation which protects the circuit from damage as a result of overheating.

Activating the thermal shutdown feature usually indicates excessive power dissipation as a result of the product of the  $(V_{IN} - V_{OUT})$  voltage and the load current. For reliable operation, limit junction temperature to a maximum of 125°C. To estimate the margin of safety in a complete design, increase the ambient temperature until the thermal protection is triggered; use worst-case loads and signal conditions.

The internal protection circuitry protects against overload conditions but is not intended to be activated in normal operation. Continuously running the device into thermal shutdown degrades device reliability.

## 7.4 Device Functional Modes

Table 1 lists a comparison between the normal, dropout, and disabled modes of operation.

**Table 1. Device Functional Modes Comparison**

OPERATING MODE	PARAMETER			
	$V_{IN}$	EN	$I_{OUT}$	$T_J$
Normal <sup>(1)</sup>	$V_{IN} > V_{OUT(NOM)} + V_{DO}$	$V_{EN} > V_{HI}$	$I_{OUT} < I_{CL}$	$T_J < T_{SD}$
Dropout <sup>(1)</sup>	$V_{IN} < V_{OUT(NOM)} + V_{DO}$	$V_{EN} > V_{HI}$	—	$T_J < T_{SD}$
Disabled <sup>(2)</sup>	$V_{IN} < V_{UVLO}$	$V_{EN} < V_{LO}$	—	$T_J > T_{SD}$

(1) All table conditions must be met.

(2) The device is disabled when any condition is met.

### 7.4.1 Normal Operation

The device regulates to the nominal output voltage when all of the following conditions are met.

- The input voltage is greater than the nominal output voltage plus the dropout voltage ( $V_{OUT(NOM)} + V_{DO}$ )
- The enable voltage has previously exceeded the enable rising threshold voltage and has not decreased below the enable falling threshold
- The output current is less than the current limit ( $I_{OUT} < I_{CL}$ )
- The device junction temperature is less than the thermal shutdown temperature ( $T_J < T_{SD}$ )

### 7.4.2 Dropout Operation

If the input voltage is lower than the nominal output voltage plus the specified dropout voltage, but all other conditions are met for normal operation, the device operates in dropout. In this mode, the output voltage tracks the input voltage. During this mode, the transient performance of the device degrades because the pass device is in a triode state and no longer controls the output voltage of the LDO. Line or load transients in dropout can result in large output-voltage deviations.

When the device is in a steady dropout state (defined as when the device is in dropout,  $V_{IN} < V_{OUT(NOM)} + V_{DO}$ , right after being in a normal regulation state, but not during startup), the pass-FET is driven as hard as possible when the control loop is out of balance. During the normal time required for the device to regain regulation,  $V_{IN} \geq V_{OUT(NOM)} + V_{DO}$ ,  $V_{OUT}$  can overshoot  $V_{OUT(NOM)}$  during fast transients.

### 7.4.3 Disabled

The output is shut down by forcing the enable pin below  $V_{LO}$ . When disabled, the pass device is turned off, internal circuits are shut down, and the output voltage is actively discharged to ground by an internal switch from the output to ground. The active pulldown is on when sufficient input voltage is provided.

## 8 Application and Implementation

### NOTE

Information in the following applications sections is not part of the TI component specification, and TI does not warrant its accuracy or completeness. TI's customers are responsible for determining suitability of components for their purposes. Customers should validate and test their design implementation to confirm system functionality.

### 8.1 Application Information

#### 8.1.1 Input and Output Capacitor Selection

The TLV757P requires an output capacitance of 0.47  $\mu\text{F}$  or larger for stability. Use X5R- and X7R-type ceramic capacitors because these capacitors have minimal variation in capacitance value and equivalent series resistance (ESR) over temperature. When selecting a capacitor for a specific application, consider the DC bias characteristics for the capacitor. Higher output voltages cause a significant derating of the capacitor. As a general rule, ceramic capacitors must be derated by 50%. For best performance, TI recommends a maximum output capacitance value of 200  $\mu\text{F}$ .

Place a 1  $\mu\text{F}$  or greater capacitor on the input pin of the LDO. Some input supplies have a high impedance. Placing a capacitor on the input supply reduces the input impedance. The input capacitor counteracts reactive input sources and improves transient response and PSRR. If the input supply has a high impedance over a large range of frequencies, several input capacitors are used in parallel to lower the impedance over frequency. Use a higher-value capacitor if large, fast, rise-time load transients are expected, or if the device is located several inches from the input power source.

#### 8.1.2 Dropout Voltage

The TLV757P uses a PMOS pass transistor to achieve low dropout. When  $(V_{\text{IN}} - V_{\text{OUT}})$  is less than the dropout voltage ( $V_{\text{DO}}$ ), the PMOS pass device is in the linear region of operation and the input-to-output resistance is the  $R_{\text{DS(ON)}}$  of the PMOS pass element.  $V_{\text{DO}}$  scales linearly with the output current because the PMOS device functions like a resistor in dropout mode. As with any linear regulator, PSRR and transient response degrade as  $(V_{\text{IN}} - V_{\text{OUT}})$  approaches dropout operation. See [Figure 14](#) and [Figure 15](#) for typical dropout values.

#### 8.1.3 Exiting Dropout

Some applications have transients that place the LDO into dropout, such as slower ramps on  $V_{\text{IN}}$  during start-up. As with other LDOs, the output may overshoot on recovery from these conditions. A ramping input supply causes an LDO to overshoot on start-up when the slew rate and voltage levels are in the correct range; see [Figure 28](#). Use an enable signal to avoid this condition.

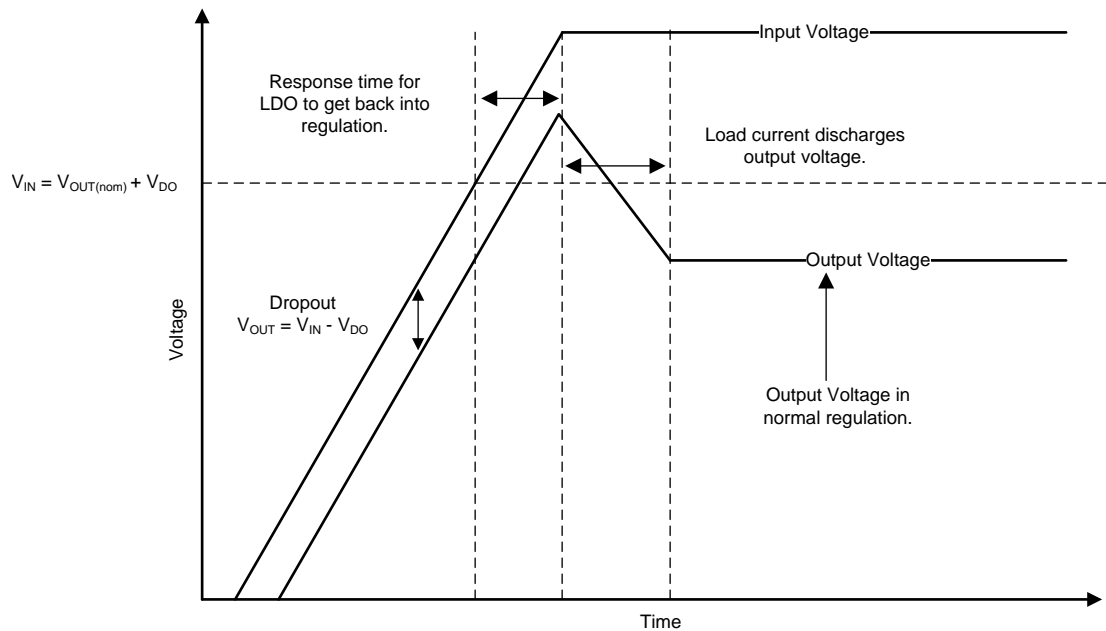
**Application Information (continued)**

**Figure 28. Startup into Dropout**

Line transients out of dropout can also cause overshoot on the output of the regulator. These overshoots are caused by the error amplifier having to drive the gate capacitance of the pass element and bring the gate back to the correct voltage for proper regulation. [Figure 29](#) illustrates what is happening internally with the gate voltage and how overshoot can be caused during operation. When the LDO is placed in dropout, the gate voltage (VGS) is pulled all the way down to give the pass device the lowest on-resistance as possible. However, if a line transient occurs while the device is in dropout, the loop is not in regulation which can cause the output to overshoot until the loop responds and the output current pulls the output voltage back down into regulation. If these transients are not acceptable, then continue to add input capacitance in the system until the transient is slow enough to reduce the overshoot.



Application Information (continued)

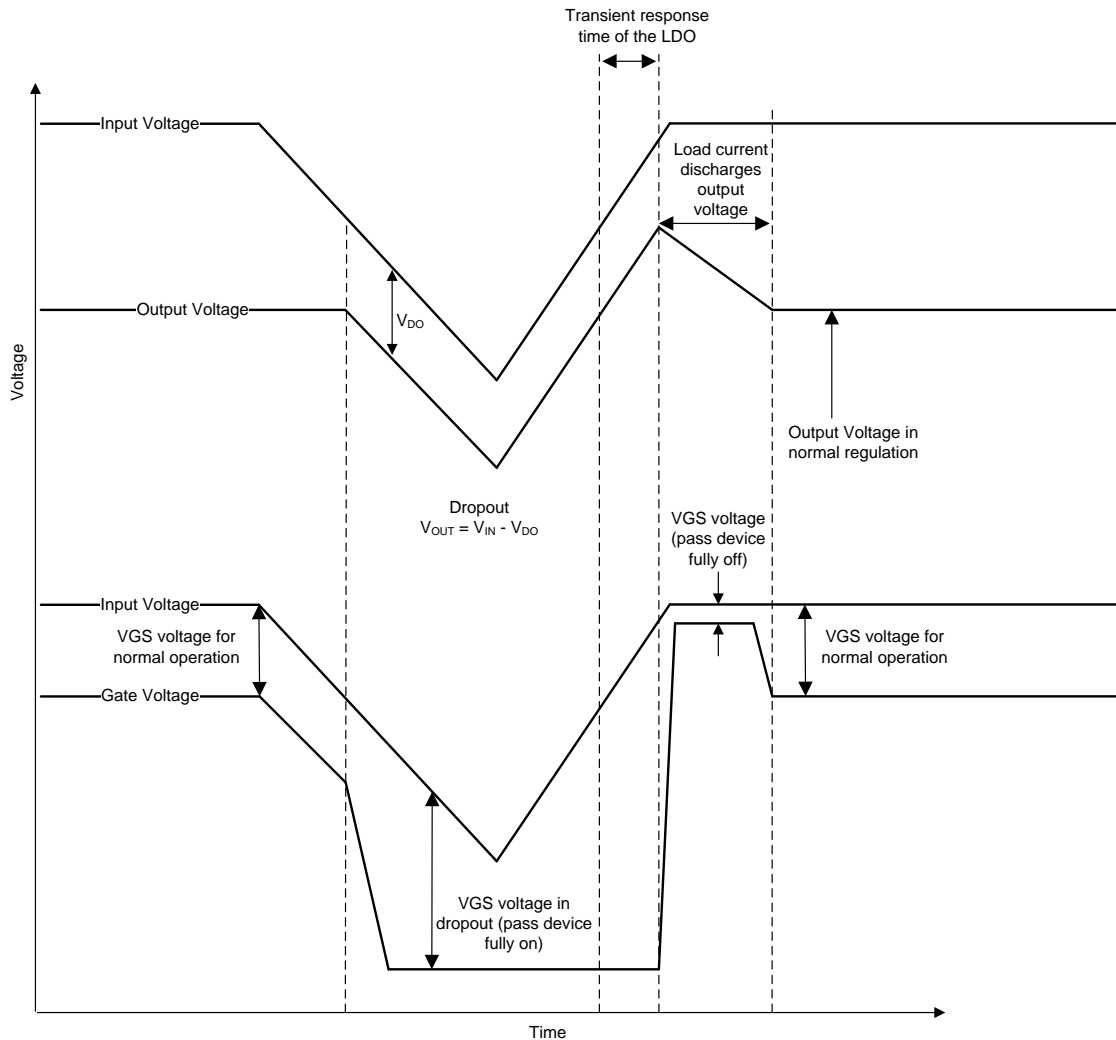

Figure 29. Line Transients From Dropout

8.1.4 Reverse Current

As with most LDOs, excessive reverse current can damage this device.

Reverse current flows through the body diode on the pass element instead of the normal conducting channel. At high magnitudes, this current flow degrades the long-term reliability of the device, as a result of one of the following conditions:

- Degradation caused by electromigration
- Excessive heat dissipation
- Potential for a latch-up condition

Conditions where reverse current can occur are outlined in this section, all of which can exceed the absolute maximum rating of  $V_{OUT} > V_{IN} + 0.3\text{ V}$ :

- If the device has a large  $C_{OUT}$  and the input supply collapses with little or no load current
- The output is biased when the input supply is not established
- The output is biased above the input supply

**Application Information (continued)**

If reverse current flow is expected in the application, external protection must be used to protect the device. [Figure 30](#) shows one approach of protecting the device.

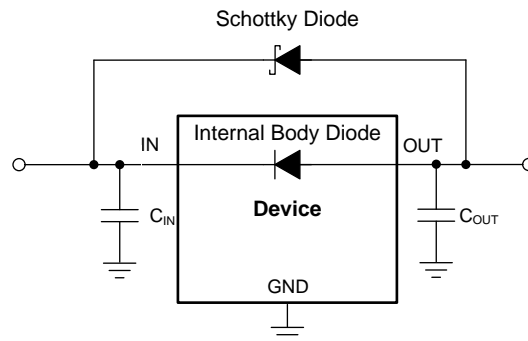

**Figure 30. Example Circuit for Reverse Current Protection Using a Schottky Diode**

**8.1.5 Power Dissipation (P<sub>D</sub>)**

Circuit reliability demands that proper consideration is given to device power dissipation, location of the circuit on the printed circuit board (PCB), and correct sizing of the thermal plane. The PCB area around the regulator must be as free of other heat-generating devices as possible that cause added thermal stresses.

As a first-order approximation, power dissipation in the regulator depends on the input-to-output voltage difference and load conditions. Use [Equation 2](#) to approximate P<sub>D</sub>:

$$P_D = (V_{IN} - V_{OUT}) \times I_{OUT} \tag{2}$$

It is important to minimize power dissipation to achieve greater efficiency. This minimizing process is achieved by selecting the correct system voltage rails. Proper selection helps obtain the minimum input-to-output voltage differential. The low dropout of the device allows for maximum efficiency across a wide range of output voltages.

The main heat conduction path for the device is through the thermal pad on the package. As such, the thermal pad must be soldered to a copper pad area under the device. This pad area should contain an array of plated vias that conduct heat to inner plane areas or to a bottom-side copper plane.

The maximum allowable junction temperature (T<sub>J</sub>) determines the maximum power dissipation for the device. Power dissipation and junction temperature are most often related by the junction-to-ambient thermal resistance (θ<sub>JA</sub>) of the combined PCB, device package, and the temperature of the ambient air (T<sub>A</sub>), according to [Equation 3](#).

$$T_J = T_A + \theta_{JA} \times P_D \tag{3}$$

Unfortunately, this thermal resistance (θ<sub>JA</sub>) is dependent on the heat-spreading capability built into the particular PCB design, and therefore varies according to the total copper area, copper weight, and location of the planes. The θ<sub>JA</sub> value is only used as a relative measure of package thermal performance. θ<sub>JA</sub> is the sum of the VQFN package junction-to-case (bottom) thermal resistance (θ<sub>JCbot</sub>) plus the thermal resistance contribution by the PCB copper.

## Application Information (continued)

### 8.1.5.1 Estimating Junction Temperature

The JEDEC standard recommends the use of psi ( $\Psi$ ) thermal metrics to estimate the junction temperatures of the LDO when in-circuit on a typical PCB board application. These metrics are not thermal resistances, but offer practical and relative means of estimating junction temperatures. These psi metrics are independent of the copper-spreading area. The key thermal metrics ( $\Psi_{JT}$  and  $\Psi_{JB}$ ) are shown in the table and are used in accordance with [Equation 4](#).

$$\Psi_{JT}: T_J = T_T + \Psi_{JT} \times P_D$$

$$\Psi_{JB}: T_J = T_B + \Psi_{JB} \times P_D$$

where:

- $P_D$  is the power dissipated as shown in [Equation 2](#)
- $T_T$  is the temperature at the center-top of the device package, and
- $T_B$  is the PCB surface temperature measured 1 mm from the device package and centered on the package edge

(4)

## 8.2 Typical Application

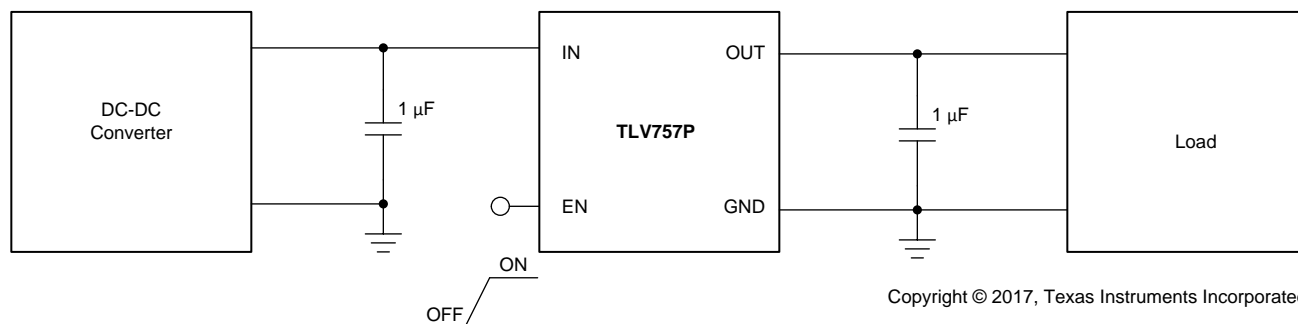

**Figure 31. TLV757P Typical Application**

### 8.2.1 Design Requirements

[Table 2](#) lists the design requirements for this application.

**Table 2. Design Parameters**

PARAMETER	DESIGN REQUIREMENT
Input voltage	2.5 V
Output voltage	1.8 V
Input current	700 mA (maximum)
Output load	600-mA DC
Maximum ambient temperature	70°C

## 8.2.2 Detailed Design Procedure

### 8.2.2.1 Input Current

During normal operation, the input current to the LDO is approximately equal to the output current of the LDO. During startup, the input current is higher as a result of the inrush current charging the output capacitor. Use Equation 5 to calculate the current through the input.

$$I_{OUT(t)} = \left[ \frac{C_{OUT} \times dV_{OUT}(t)}{dt} \right] + \left[ \frac{V_{OUT}(t)}{R_{LOAD}} \right]$$

where:

- $V_{OUT}(t)$  is the instantaneous output voltage of the turn-on ramp
  - $dV_{OUT}(t) / dt$  is the slope of the  $V_{OUT}$  ramp
  - $R_{LOAD}$  is the resistive load impedance
- (5)

### 8.2.2.2 Thermal Dissipation

The junction temperature can be determined using the junction-to-ambient thermal resistance ( $R_{\theta JA}$ ) and the total power dissipation ( $P_D$ ). Use Equation 6 to calculate the power dissipation. Multiply  $P_D$  by  $R_{\theta JA}$  and add the ambient temperature ( $T_A$ ) to calculate the junction temperature ( $T_J$ ) as Equation 7 shows.

$$P_D = (I_{GND} + I_{OUT}) \times (V_{IN} - V_{OUT}) \tag{6}$$

$$T_J = R_{\theta JA} \times P_D + T_A \tag{7}$$

If the ( $T_{J(MAX)}$ ) value does not exceed  $125^\circ\text{C}$  calculate the maximum ambient temperature as Equation 8 shows. Equation 9 calculates the maximum ambient temperature with a value of  $82.916^\circ\text{C}$ .

$$T_{A(MAX)} = T_{J(MAX)} - R_{\theta JA} \times P_D \tag{8}$$

$$T_{A(MAX)} = 125^\circ\text{C} - 100.2 \times (2.5\text{ V} - 1.8\text{ V}) \times (0.6\text{ A}) = 82.916^\circ\text{C} \tag{9}$$

## 8.2.3 Application Curves

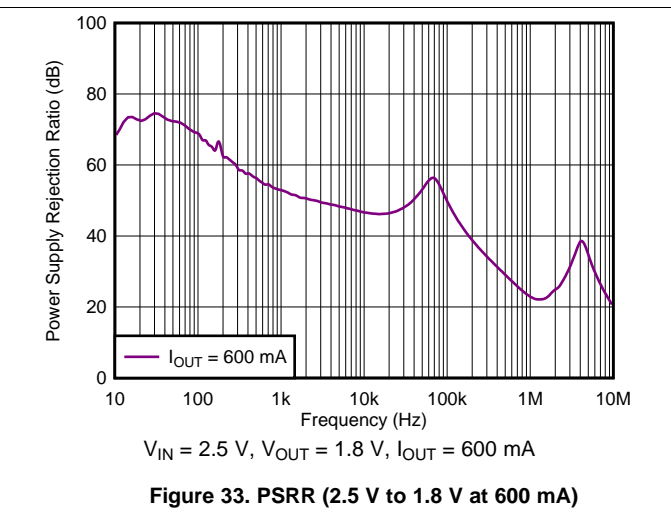
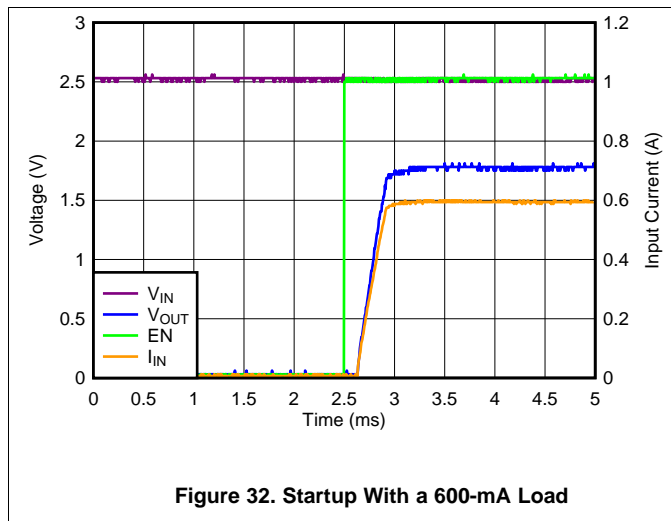

## 9 Power Supply Recommendations

Connect a low output impedance power supply directly to the IN pin of the TLV757P. If the input source is reactive, consider using multiple input capacitors in parallel with the 1- $\mu\text{F}$  input capacitor to lower the input supply impedance over frequency.

## 10 Layout

### 10.1 Layout Guidelines

- Place input and output capacitors as close as possible to the device.
- Use copper planes for device connections to optimize thermal performance.
- Place thermal vias around the device to distribute the heat.

### 10.2 Layout Examples

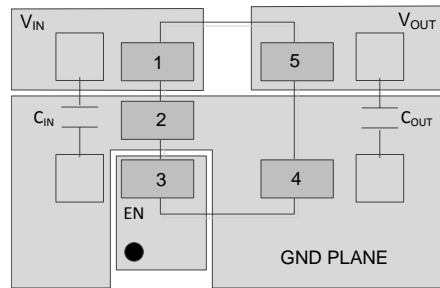

● Represents via used for application specific connections

**Figure 34. Layout Example: DBV Package**

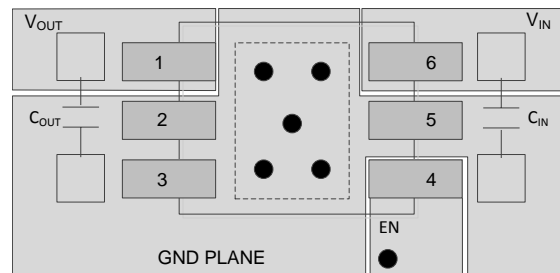

● Represents via used for application specific connections

**Figure 35. Layout Example: DRV Package**

## 11 Device and Documentation Support

### 11.1 Device Support

#### 11.1.1 Device Nomenclature

**Table 3. Device Nomenclature<sup>(1)(2)</sup>**

PRODUCT	V <sub>OUT</sub>
TLV757xx(x)Pyyyz	<p><b>xx(x)</b> is the nominal output voltage. For output voltages with a resolution of 50 mV, two digits are used in the ordering number; otherwise, three digits are used (for example, 28 = 2.8 V; 125 = 1.25 V).</p> <p><b>P</b> indicates an active output discharge feature. All members of the TLV757P family will actively discharge the output when the device is disabled.</p> <p><b>yyy</b> is the package designator.</p> <p><b>z</b> is the package quantity. R is for reel (3000 pieces), T is for tape (250 pieces).</p>

- (1) For the most current package and ordering information see the Package Option Addendum at the end of this document, or visit the device product folder on [www.ti.com](http://www.ti.com).
- (2) Output voltages from 0.6 V to 5 V in 50-mV increments are available. Contact the factory for details and availability.

### 11.2 Receiving Notification of Documentation Updates

To receive notification of documentation updates, navigate to the device product folder on ti.com. In the upper right corner, click on *Alert me* to register and receive a weekly digest of any product information that has changed. For change details, review the revision history included in any revised document.

### 11.3 Community Resources

The following links connect to TI community resources. Linked contents are provided "AS IS" by the respective contributors. They do not constitute TI specifications and do not necessarily reflect TI's views; see TI's [Terms of Use](#).

**TI E2E™ Online Community** *TI's Engineer-to-Engineer (E2E) Community*. Created to foster collaboration among engineers. At [e2e.ti.com](http://e2e.ti.com), you can ask questions, share knowledge, explore ideas and help solve problems with fellow engineers.

**Design Support** *TI's Design Support* Quickly find helpful E2E forums along with design support tools and contact information for technical support.

### 11.4 Trademarks

E2E is a trademark of Texas Instruments.  
All other trademarks are the property of their respective owners.

### 11.5 Electrostatic Discharge Caution



This integrated circuit can be damaged by ESD. Texas Instruments recommends that all integrated circuits be handled with appropriate precautions. Failure to observe proper handling and installation procedures can cause damage.

ESD damage can range from subtle performance degradation to complete device failure. Precision integrated circuits may be more susceptible to damage because very small parametric changes could cause the device not to meet its published specifications.

### 11.6 Glossary

**SLYZ022** — *TI Glossary*.

This glossary lists and explains terms, acronyms, and definitions.

## 12 Mechanical, Packaging, and Orderable Information

The following pages include mechanical, packaging, and orderable information. This information is the most current data available for the designated devices. This data is subject to change without notice and revision of this document. For browser-based versions of this data sheet, refer to the left-hand navigation.

**PACKAGING INFORMATION**

Orderable Device	Status (1)	Package Type	Package Drawing	Pins	Package Qty	Eco Plan (2)	Lead finish/ Ball material (6)	MSL Peak Temp (3)	Op Temp (°C)	Device Marking (4/5)	Samples
TLV75709PDBVR	ACTIVE	SOT-23	DBV	5	3000	RoHS & Green	NIPDAU   SN	Level-1-260C-UNLIM	-40 to 125	1H8F	<a href="#">Samples</a>
TLV75709PDRVR	ACTIVE	WSON	DRV	6	3000	RoHS & Green	NIPDAU	Level-1-260C-UNLIM	-40 to 125	1HGH	<a href="#">Samples</a>
TLV75710PDBVR	ACTIVE	SOT-23	DBV	5	3000	RoHS & Green	NIPDAU   SN	Level-1-260C-UNLIM	-40 to 125	1FEF	<a href="#">Samples</a>
TLV75710PDRVR	ACTIVE	WSON	DRV	6	3000	RoHS & Green	NIPDAU	Level-1-260C-UNLIM	-40 to 125	1HHH	<a href="#">Samples</a>
TLV75712PDBVR	ACTIVE	SOT-23	DBV	5	3000	RoHS & Green	NIPDAU   SN	Level-1-260C-UNLIM	-40 to 125	1FFF	<a href="#">Samples</a>
TLV75712PDRVR	ACTIVE	WSON	DRV	6	3000	RoHS & Green	NIPDAU	Level-1-260C-UNLIM	-40 to 125	1HIH	<a href="#">Samples</a>
TLV75715PDBVR	ACTIVE	SOT-23	DBV	5	3000	RoHS & Green	NIPDAU   SN	Level-1-260C-UNLIM	-40 to 125	1FGF	<a href="#">Samples</a>
TLV75715PDRVR	ACTIVE	WSON	DRV	6	3000	RoHS & Green	NIPDAU	Level-1-260C-UNLIM	-40 to 125	1HJH	<a href="#">Samples</a>
TLV75718PDBVR	ACTIVE	SOT-23	DBV	5	3000	RoHS & Green	NIPDAU   SN	Level-1-260C-UNLIM	-40 to 125	1FHF	<a href="#">Samples</a>
TLV75718PDRVR	ACTIVE	WSON	DRV	6	3000	RoHS & Green	NIPDAU	Level-1-260C-UNLIM	-40 to 125	1HKH	<a href="#">Samples</a>
TLV75719PDBVR	ACTIVE	SOT-23	DBV	5	3000	RoHS & Green	NIPDAU   SN	Level-1-260C-UNLIM	-40 to 125	1H7F	<a href="#">Samples</a>
TLV75719PDRVR	ACTIVE	WSON	DRV	6	3000	RoHS & Green	NIPDAU	Level-1-260C-UNLIM	-40 to 125	1HLH	<a href="#">Samples</a>
TLV75725PDBVR	ACTIVE	SOT-23	DBV	5	3000	RoHS & Green	NIPDAU   SN	Level-1-260C-UNLIM	-40 to 125	1FIF	<a href="#">Samples</a>
TLV75725PDRVR	ACTIVE	WSON	DRV	6	3000	RoHS & Green	NIPDAU	Level-1-260C-UNLIM	-40 to 125	1HMH	<a href="#">Samples</a>
TLV75728PDBVR	ACTIVE	SOT-23	DBV	5	3000	RoHS & Green	NIPDAU   SN	Level-1-260C-UNLIM	-40 to 125	1FJF	<a href="#">Samples</a>
TLV75728PDRVR	ACTIVE	WSON	DRV	6	3000	RoHS & Green	NIPDAU	Level-1-260C-UNLIM	-40 to 125	1HNH	<a href="#">Samples</a>
TLV75729PDBVR	ACTIVE	SOT-23	DBV	5	3000	RoHS & Green	NIPDAU   SN	Level-1-260C-UNLIM	-40 to 125	1H9F	<a href="#">Samples</a>
TLV75730PDBVR	ACTIVE	SOT-23	DBV	5	3000	RoHS & Green	NIPDAU   SN	Level-1-260C-UNLIM	-40 to 125	1GHF	<a href="#">Samples</a>
TLV75730PDRVR	ACTIVE	WSON	DRV	6	3000	RoHS & Green	NIPDAU	Level-1-260C-UNLIM	-40 to 125	1HOH	<a href="#">Samples</a>
TLV75733PDBVR	ACTIVE	SOT-23	DBV	5	3000	RoHS & Green	NIPDAU   SN	Level-1-260C-UNLIM	-40 to 125	1FKF	<a href="#">Samples</a>

Orderable Device	Status (1)	Package Type	Package Drawing	Pins	Package Qty	Eco Plan (2)	Lead finish/ Ball material (6)	MSL Peak Temp (3)	Op Temp (°C)	Device Marking (4/5)	Samples
TLV75733PDRVR	ACTIVE	WSON	DRV	6	3000	RoHS & Green	NIPDAU	Level-1-260C-UNLIM	-40 to 125	1HPH	<a href="#">Samples</a>
TLV75740PDRVR	ACTIVE	WSON	DRV	6	3000	RoHS & Green	NIPDAU	Level-1-260C-UNLIM	-40 to 125	1HQH	<a href="#">Samples</a>

(1) The marketing status values are defined as follows:

**ACTIVE:** Product device recommended for new designs.

**LIFEBUY:** TI has announced that the device will be discontinued, and a lifetime-buy period is in effect.

**NRND:** Not recommended for new designs. Device is in production to support existing customers, but TI does not recommend using this part in a new design.

**PREVIEW:** Device has been announced but is not in production. Samples may or may not be available.

**OBSOLETE:** TI has discontinued the production of the device.

(2) **RoHS:** TI defines "RoHS" to mean semiconductor products that are compliant with the current EU RoHS requirements for all 10 RoHS substances, including the requirement that RoHS substance do not exceed 0.1% by weight in homogeneous materials. Where designed to be soldered at high temperatures, "RoHS" products are suitable for use in specified lead-free processes. TI may reference these types of products as "Pb-Free".

**RoHS Exempt:** TI defines "RoHS Exempt" to mean products that contain lead but are compliant with EU RoHS pursuant to a specific EU RoHS exemption.

**Green:** TI defines "Green" to mean the content of Chlorine (Cl) and Bromine (Br) based flame retardants meet JS709B low halogen requirements of <=1000ppm threshold. Antimony trioxide based flame retardants must also meet the <=1000ppm threshold requirement.

(3) MSL, Peak Temp. - The Moisture Sensitivity Level rating according to the JEDEC industry standard classifications, and peak solder temperature.

(4) There may be additional marking, which relates to the logo, the lot trace code information, or the environmental category on the device.

(5) Multiple Device Markings will be inside parentheses. Only one Device Marking contained in parentheses and separated by a "~" will appear on a device. If a line is indented then it is a continuation of the previous line and the two combined represent the entire Device Marking for that device.

(6) Lead finish/Ball material - Orderable Devices may have multiple material finish options. Finish options are separated by a vertical ruled line. Lead finish/Ball material values may wrap to two lines if the finish value exceeds the maximum column width.

**Important Information and Disclaimer:**The information provided on this page represents TI's knowledge and belief as of the date that it is provided. TI bases its knowledge and belief on information provided by third parties, and makes no representation or warranty as to the accuracy of such information. Efforts are underway to better integrate information from third parties. TI has taken and continues to take reasonable steps to provide representative and accurate information but may not have conducted destructive testing or chemical analysis on incoming materials and chemicals. TI and TI suppliers consider certain information to be proprietary, and thus CAS numbers and other limited information may not be available for release.

In no event shall TI's liability arising out of such information exceed the total purchase price of the TI part(s) at issue in this document sold by TI to Customer on an annual basis.



**TAPE AND REEL INFORMATION**

**QUADRANT ASSIGNMENTS FOR PIN 1 ORIENTATION IN TAPE**

\*All dimensions are nominal

Device	Package Type	Package Drawing	Pins	SPQ	Reel Diameter (mm)	Reel Width W1 (mm)	A0 (mm)	B0 (mm)	K0 (mm)	P1 (mm)	W (mm)	Pin1 Quadrant
TLV75709PDBVR	SOT-23	DBV	5	3000	180.0	8.4	3.2	3.2	1.4	4.0	8.0	Q3
TLV75709PDRVR	WSON	DRV	6	3000	180.0	8.4	2.3	2.3	1.15	4.0	8.0	Q2
TLV75710PDBVR	SOT-23	DBV	5	3000	180.0	8.4	3.2	3.2	1.4	4.0	8.0	Q3
TLV75710PDBVR	SOT-23	DBV	5	3000	180.0	8.4	3.2	3.2	1.4	4.0	8.0	Q3
TLV75710PDRVR	WSON	DRV	6	3000	180.0	8.4	2.3	2.3	1.15	4.0	8.0	Q2
TLV75712PDBVR	SOT-23	DBV	5	3000	180.0	8.4	3.2	3.2	1.4	4.0	8.0	Q3
TLV75712PDRVR	WSON	DRV	6	3000	180.0	8.4	2.3	2.3	1.15	4.0	8.0	Q2
TLV75715PDBVR	SOT-23	DBV	5	3000	180.0	8.4	3.2	3.2	1.4	4.0	8.0	Q3
TLV75715PDBVR	SOT-23	DBV	5	3000	180.0	8.4	3.2	3.2	1.4	4.0	8.0	Q3
TLV75715PDRVR	WSON	DRV	6	3000	180.0	8.4	2.3	2.3	1.15	4.0	8.0	Q2
TLV75718PDBVR	SOT-23	DBV	5	3000	180.0	8.4	3.2	3.2	1.4	4.0	8.0	Q3
TLV75718PDRVR	WSON	DRV	6	3000	180.0	8.4	2.3	2.3	1.15	4.0	8.0	Q2
TLV75719PDBVR	SOT-23	DBV	5	3000	180.0	8.4	3.2	3.2	1.4	4.0	8.0	Q3
TLV75719PDBVR	SOT-23	DBV	5	3000	180.0	8.4	3.2	3.2	1.4	4.0	8.0	Q3
TLV75719PDRVR	WSON	DRV	6	3000	180.0	8.4	2.3	2.3	1.15	4.0	8.0	Q2
TLV75725PDBVR	SOT-23	DBV	5	3000	180.0	8.4	3.2	3.2	1.4	4.0	8.0	Q3

Device	Package Type	Package Drawing	Pins	SPQ	Reel Diameter (mm)	Reel Width W1 (mm)	A0 (mm)	B0 (mm)	K0 (mm)	P1 (mm)	W (mm)	Pin1 Quadrant
TLV75725PDBVR	SOT-23	DBV	5	3000	180.0	8.4	3.2	3.2	1.4	4.0	8.0	Q3
TLV75725PDRVR	WSON	DRV	6	3000	180.0	8.4	2.3	2.3	1.15	4.0	8.0	Q2
TLV75728PDBVR	SOT-23	DBV	5	3000	180.0	8.4	3.2	3.2	1.4	4.0	8.0	Q3
TLV75728PDBVR	SOT-23	DBV	5	3000	180.0	8.4	3.2	3.2	1.4	4.0	8.0	Q3
TLV75728PDRVR	WSON	DRV	6	3000	180.0	8.4	2.3	2.3	1.15	4.0	8.0	Q2
TLV75729PDBVR	SOT-23	DBV	5	3000	180.0	8.4	3.2	3.2	1.4	4.0	8.0	Q3
TLV75729PDBVR	SOT-23	DBV	5	3000	180.0	8.4	3.2	3.2	1.4	4.0	8.0	Q3
TLV75730PDBVR	SOT-23	DBV	5	3000	180.0	8.4	3.2	3.2	1.4	4.0	8.0	Q3
TLV75730PDRVR	WSON	DRV	6	3000	180.0	8.4	2.3	2.3	1.15	4.0	8.0	Q2
TLV75733PDBVR	SOT-23	DBV	5	3000	180.0	8.4	3.2	3.2	1.4	4.0	8.0	Q3
TLV75733PDRVR	WSON	DRV	6	3000	180.0	8.4	2.3	2.3	1.15	4.0	8.0	Q2
TLV75740PDRVR	WSON	DRV	6	3000	180.0	8.4	2.3	2.3	1.15	4.0	8.0	Q2

**TAPE AND REEL BOX DIMENSIONS**

\*All dimensions are nominal

Device	Package Type	Package Drawing	Pins	SPQ	Length (mm)	Width (mm)	Height (mm)
TLV75709PDBVR	SOT-23	DBV	5	3000	210.0	185.0	35.0
TLV75709PDRVR	WSON	DRV	6	3000	210.0	185.0	35.0
TLV75710PDBVR	SOT-23	DBV	5	3000	210.0	185.0	35.0
TLV75710PDBVR	SOT-23	DBV	5	3000	210.0	185.0	35.0
TLV75710PDRVR	WSON	DRV	6	3000	210.0	185.0	35.0
TLV75712PDBVR	SOT-23	DBV	5	3000	210.0	185.0	35.0
TLV75712PDRVR	WSON	DRV	6	3000	210.0	185.0	35.0
TLV75715PDBVR	SOT-23	DBV	5	3000	210.0	185.0	35.0
TLV75715PDBVR	SOT-23	DBV	5	3000	210.0	185.0	35.0
TLV75715PDRVR	WSON	DRV	6	3000	210.0	185.0	35.0
TLV75718PDBVR	SOT-23	DBV	5	3000	210.0	185.0	35.0
TLV75718PDRVR	WSON	DRV	6	3000	210.0	185.0	35.0
TLV75719PDBVR	SOT-23	DBV	5	3000	210.0	185.0	35.0
TLV75719PDBVR	SOT-23	DBV	5	3000	210.0	185.0	35.0
TLV75719PDRVR	WSON	DRV	6	3000	210.0	185.0	35.0
TLV75725PDBVR	SOT-23	DBV	5	3000	210.0	185.0	35.0
TLV75725PDBVR	SOT-23	DBV	5	3000	210.0	185.0	35.0
TLV75725PDRVR	WSON	DRV	6	3000	210.0	185.0	35.0

---

<b>Device</b>	<b>Package Type</b>	<b>Package Drawing</b>	<b>Pins</b>	<b>SPQ</b>	<b>Length (mm)</b>	<b>Width (mm)</b>	<b>Height (mm)</b>
TLV75728PDBVR	SOT-23	DBV	5	3000	210.0	185.0	35.0
TLV75728PDBVR	SOT-23	DBV	5	3000	210.0	185.0	35.0
TLV75728PDRVR	WSON	DRV	6	3000	210.0	185.0	35.0
TLV75729PDBVR	SOT-23	DBV	5	3000	210.0	185.0	35.0
TLV75729PDBVR	SOT-23	DBV	5	3000	210.0	185.0	35.0
TLV75730PDBVR	SOT-23	DBV	5	3000	210.0	185.0	35.0
TLV75730PDRVR	WSON	DRV	6	3000	210.0	185.0	35.0
TLV75733PDBVR	SOT-23	DBV	5	3000	210.0	185.0	35.0
TLV75733PDRVR	WSON	DRV	6	3000	210.0	185.0	35.0
TLV75740PDRVR	WSON	DRV	6	3000	210.0	185.0	35.0

## GENERIC PACKAGE VIEW

DRV 6

WSON - 0.8 mm max height

PLASTIC SMALL OUTLINE - NO LEAD



Images above are just a representation of the package family, actual package may vary.  
Refer to the product data sheet for package details.

4206925/F

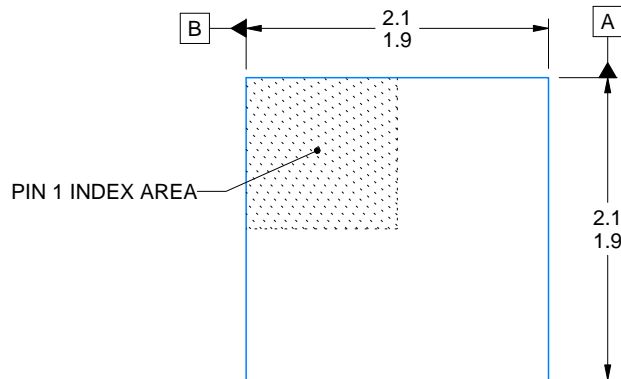
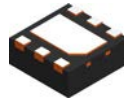

4222173/B 04/2018

NOTES:

1. All linear dimensions are in millimeters. Any dimensions in parenthesis are for reference only. Dimensioning and tolerancing per ASME Y14.5M.
2. This drawing is subject to change without notice.
3. The package thermal pad must be soldered to the printed circuit board for thermal and mechanical performance.



# EXAMPLE STENCIL DESIGN

DRV0006A

WSON - 0.8 mm max height

PLASTIC SMALL OUTLINE - NO LEAD



SOLDER PASTE EXAMPLE  
BASED ON 0.125 mm THICK STENCIL

EXPOSED PAD #7  
88% PRINTED SOLDER COVERAGE BY AREA UNDER PACKAGE  
SCALE:30X

4222173/B 04/2018

NOTES: (continued)

6. Laser cutting apertures with trapezoidal walls and rounded corners may offer better paste release. IPC-7525 may have alternate design recommendations.



DBV0005A



# PACKAGE OUTLINE

SOT-23 - 1.45 mm max height

SMALL OUTLINE TRANSISTOR

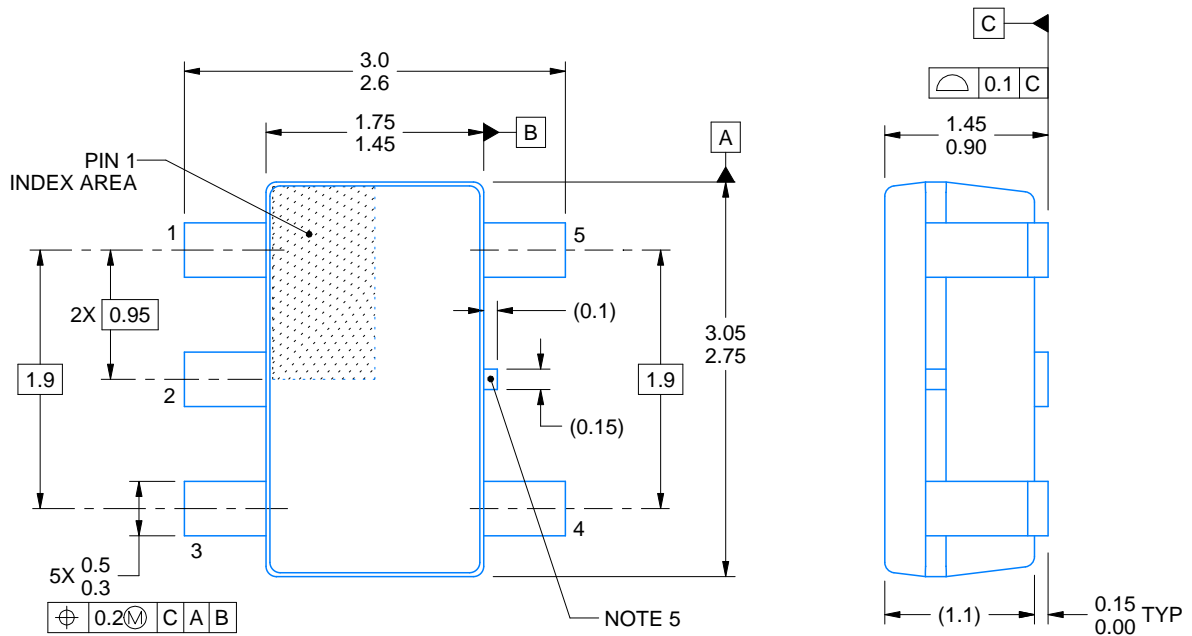

4214839/G 03/2023

## NOTES:

1. All linear dimensions are in millimeters. Any dimensions in parenthesis are for reference only. Dimensioning and tolerancing per ASME Y14.5M.
2. This drawing is subject to change without notice.
3. Reference JEDEC MO-178.
4. Body dimensions do not include mold flash, protrusions, or gate burrs. Mold flash, protrusions, or gate burrs shall not exceed 0.25 mm per side.
5. Support pin may differ or may not be present.

# EXAMPLE BOARD LAYOUT

DBV0005A

SOT-23 - 1.45 mm max height

SMALL OUTLINE TRANSISTOR

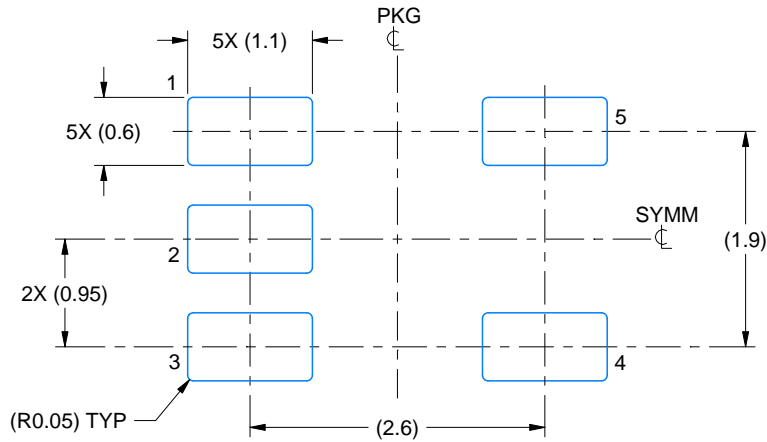

LAND PATTERN EXAMPLE  
EXPOSED METAL SHOWN  
SCALE:15X

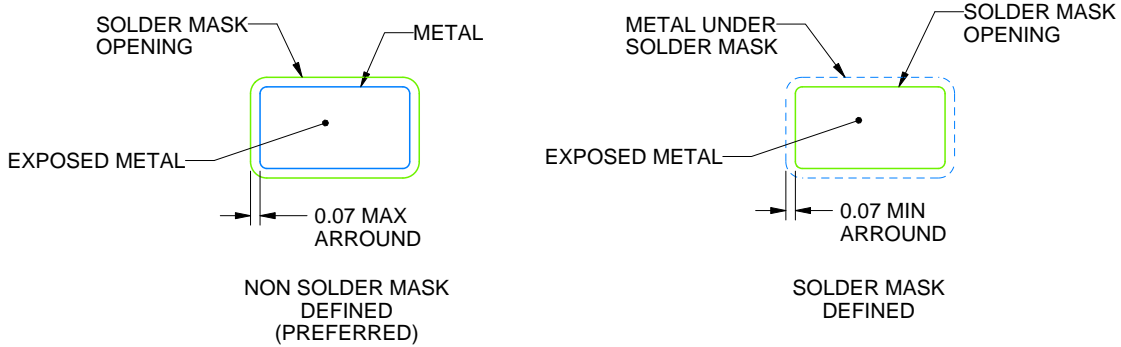

SOLDER MASK DETAILS

4214839/G 03/2023

NOTES: (continued)

- 6. Publication IPC-7351 may have alternate designs.
- 7. Solder mask tolerances between and around signal pads can vary based on board fabrication site.

# EXAMPLE STENCIL DESIGN

DBV0005A

SOT-23 - 1.45 mm max height

SMALL OUTLINE TRANSISTOR

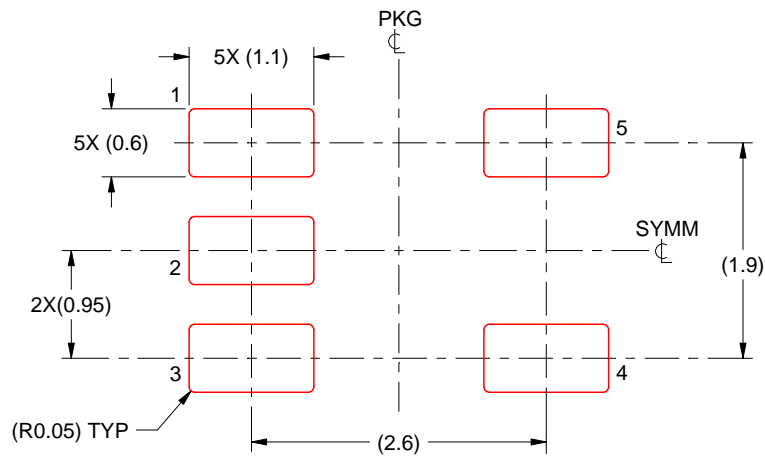

SOLDER PASTE EXAMPLE  
BASED ON 0.125 mm THICK STENCIL  
SCALE:15X

4214839/G 03/2023

NOTES: (continued)

8. Laser cutting apertures with trapezoidal walls and rounded corners may offer better paste release. IPC-7525 may have alternate design recommendations.
9. Board assembly site may have different recommendations for stencil design.

## IMPORTANT NOTICE AND DISCLAIMER

TI PROVIDES TECHNICAL AND RELIABILITY DATA (INCLUDING DATA SHEETS), DESIGN RESOURCES (INCLUDING REFERENCE DESIGNS), APPLICATION OR OTHER DESIGN ADVICE, WEB TOOLS, SAFETY INFORMATION, AND OTHER RESOURCES "AS IS" AND WITH ALL FAULTS, AND DISCLAIMS ALL WARRANTIES, EXPRESS AND IMPLIED, INCLUDING WITHOUT LIMITATION ANY IMPLIED WARRANTIES OF MERCHANTABILITY, FITNESS FOR A PARTICULAR PURPOSE OR NON-INFRINGEMENT OF THIRD PARTY INTELLECTUAL PROPERTY RIGHTS.

These resources are intended for skilled developers designing with TI products. You are solely responsible for (1) selecting the appropriate TI products for your application, (2) designing, validating and testing your application, and (3) ensuring your application meets applicable standards, and any other safety, security, regulatory or other requirements.

These resources are subject to change without notice. TI grants you permission to use these resources only for development of an application that uses the TI products described in the resource. Other reproduction and display of these resources is prohibited. No license is granted to any other TI intellectual property right or to any third party intellectual property right. TI disclaims responsibility for, and you will fully indemnify TI and its representatives against, any claims, damages, costs, losses, and liabilities arising out of your use of these resources.

TI's products are provided subject to [TI's Terms of Sale](#) or other applicable terms available either on [ti.com](https://www.ti.com) or provided in conjunction with such TI products. TI's provision of these resources does not expand or otherwise alter TI's applicable warranties or warranty disclaimers for TI products.

TI objects to and rejects any additional or different terms you may have proposed.

Mailing Address: Texas Instruments, Post Office Box 655303, Dallas, Texas 75265  
Copyright © 2023, Texas Instruments Incorporated