

PM130N120LH_G

1,200V 20A 130mΩ Silicon Carbide MOSFET

Features

- Low On-Resistance
- High-Speed Switching
- High-Frequency Operation
- Fast Reverse Recovery
- Easy to Parallel & Simple to Drive
- Halogen Free, RoHS Compliant

Package Outline

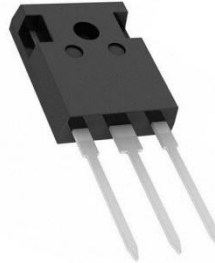

Gate Drain Source

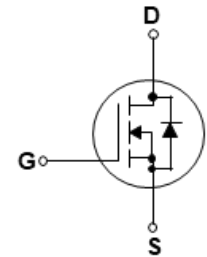

Applications

- Switch Mode Power Supplies
- Solar Inverters
- DC/DC Converters
- Battery Chargers
- Motor Drives
- Induction Heating

Absolute Maximum Ratings

 $T_C = 25^\circ\text{C}$ unless otherwise noted

Symbol	Parameter	Value	Units
V_{DSS}	Drain-Source Voltage	1200	V
I_D	Drain Current - Continuous ($T_C = 25^\circ\text{C}$)	20	A
	- Continuous ($T_C = 100^\circ\text{C}$)	16	A
I_{DM}	Drain Current - Pulsed	40	A
V_{GSS_surge}	Gate-Source Voltage ($t_{surge} < 300\text{ns}$)	-7 / +24	V
V_{GSS}	Gate-Source Voltage (DC)	-5 / +20	V
P_D	Power Dissipation ($T_C = 25^\circ\text{C}$)	115	W
	- Derate above 25°C	0.77	W/ $^\circ\text{C}$
T_J, T_{STG}	Operating and Storage Temperature Range	-55 to +175	$^\circ\text{C}$
T_L	Maximum lead temperature for soldering purposes, 1/8" from case for 5 seconds	260	$^\circ\text{C}$

Thermal Characteristics

Symbol	Parameter	Value	Units
$R_{\theta JC}$	Thermal Resistance, Junction-to-Case	1.3	$^\circ\text{C}/\text{W}$
$R_{\theta JA}$	Thermal Resistance, Junction-to-Ambient	40	$^\circ\text{C}/\text{W}$

Electrical Characteristics $T_C = 25^\circ\text{C}$ unless otherwise noted

Symbol	Parameter	Test Conditions	Min	Typ	Max	Units
Off Characteristics						
BV_{DSS}	Drain-Source Breakdown Voltage	$V_{GS} = 0\text{ V}, I_D = 250\text{ }\mu\text{A}$	1200	--	--	V
I_{DSS}	Zero Gate Voltage Drain Current	$V_{DS} = 1200\text{ V}, V_{GS} = 0\text{ V}$	--	--	200	μA
I_{GSS}	Gate-Body Leakage Current	$V_{GS} = 20\text{ V}, V_{DS} = 0\text{ V}$	--	--	250	nA
On Characteristics						
$V_{GS(th)}$	Gate Threshold Voltage	$V_{DS} = V_{GS}, I_D = 2.5\text{ mA}$	1.5	--	4.0	V
$R_{DS(on)}$	Static Drain-Source On-Resistance	$V_{GS} = 20\text{ V}, I_D = 10\text{ A}$	--	130	160	m Ω
Dynamic Characteristics						
C_{iss}	Input Capacitance	$V_{DS} = 800\text{ V}, V_{GS} = 0\text{ V},$ $f = 1.0\text{ MHz}$	--	1000	--	pF
C_{oss}	Output Capacitance		--	70	--	pF
C_{rss}	Reverse Transfer Capacitance		--	15	--	pF
Switching Characteristics						
$t_{d(on)}$	Turn-On Delay Time	$V_{DD} = 600\text{ V}, V_{GS} = -5 / 20\text{ V},$ $I_D = 20\text{ A},$ $R_L = 30\text{ }\Omega, R_G = 4.7\text{ }\Omega$	--	22	--	ns
t_r	Turn-On Rise Time		--	22	--	
$t_{d(off)}$	Turn-Off Delay Time		--	20	--	
t_f	Turn-Off Fall Time		--	17	--	
E_{on}	Turn-On Switching loss	$V_{DD} = 600\text{ V}, V_{GS} = -5 / 20\text{ V}$ $L = 0.3\text{ mH}, R_G = 4.7\text{ }\Omega$	--	120	--	μJ
E_{off}	Turn-Off Switching loss		--	85	--	
Q_g	Total Gate Charge	$V_{DS} = 600\text{ V}, I_D = 20\text{ A},$ $V_{GS} = -5 / 20\text{ V}$	--	62	--	nC
Q_{gs}	Gate-Source Charge		--	18	--	
Q_{gd}	Gate-Drain Charge		--	27	--	
Drain-Source Diode Characteristics and Maximum Ratings						
I_S	Maximum Continuous Drain-Source Diode Forward Current		--	--	20	A
I_{SM}	Maximum Pulsed Drain-Source Diode Forward Current		--	--	40	A
V_{SD}	Diode Forward Voltage	$V_{GS} = 0\text{ V}, I_S = 10\text{ A}$	--	4.5	--	V
t_{rr}	Reverse Recovery Time	$V_R = 600\text{ V}, V_{GS} = -5 / 20\text{ V},$ $I_S = 20\text{ A}, di_F / dt = 1000\text{ A}/\mu\text{s}$	--	50	--	ns
Q_{rr}	Reverse Recovery Charge		--	120	--	nC

Typical Characteristics

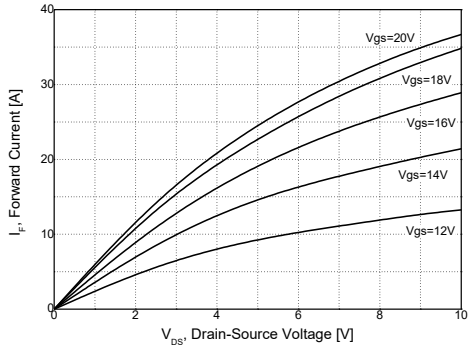

Figure 1. On-State Characteristics

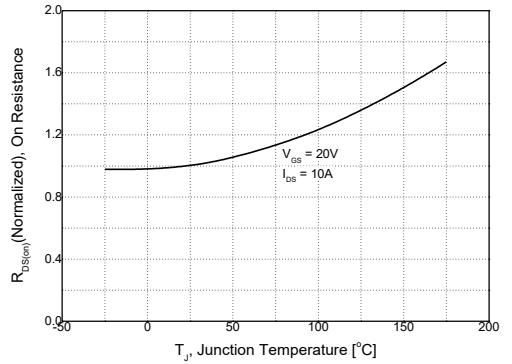

Figure 2. On Resistance Variation vs. Junction Temperature

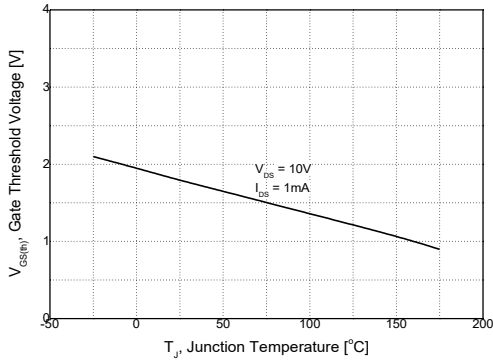

Figure 3. Gate Threshold Voltage vs. Junction Temperature

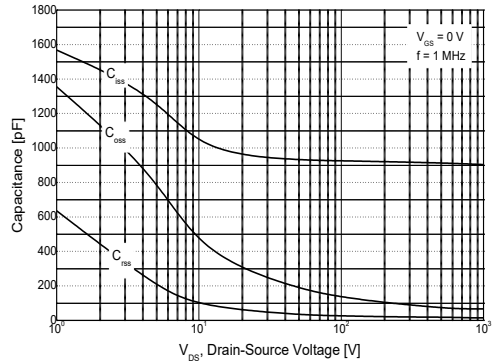

Figure 4. Capacitance Characteristics

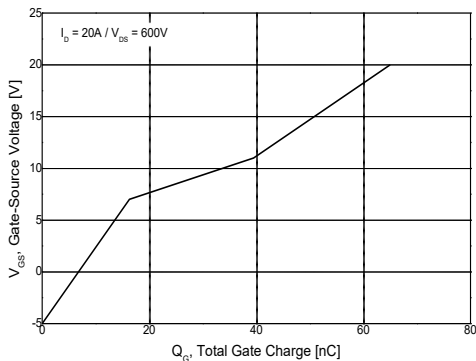

Figure 5. Gate Charge Characteristics

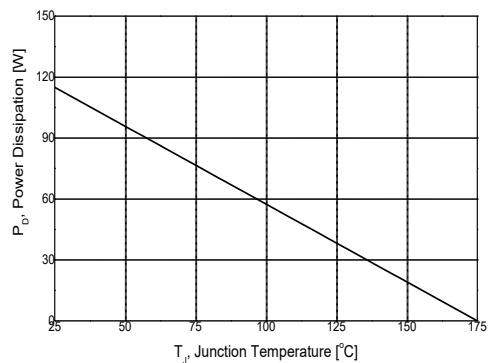

Figure 6. Power Dissipation

Typical Characteristics

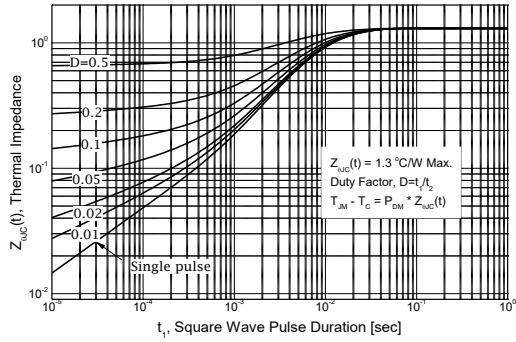

Figure 7. Transient Thermal Response

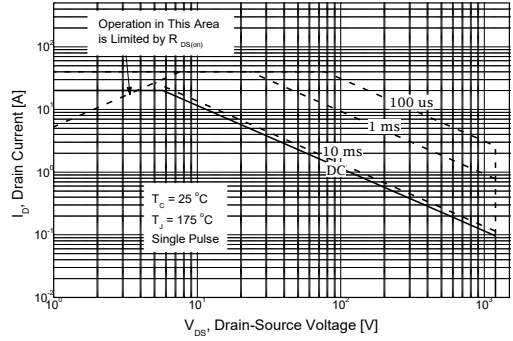
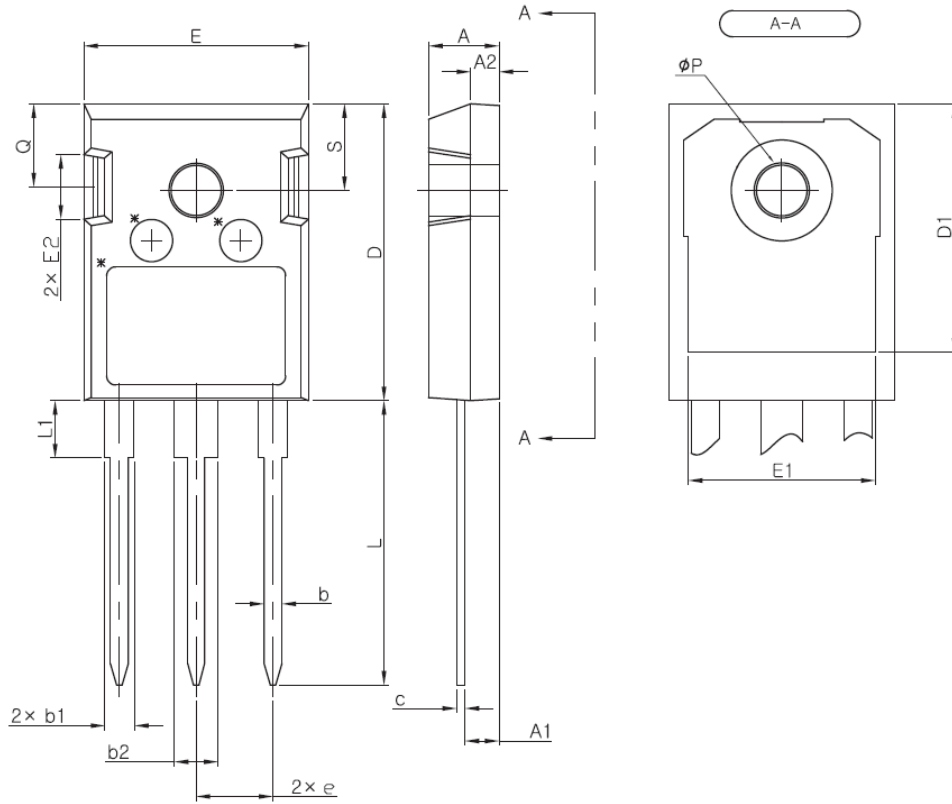

Figure 8. Maximum Safe Operating Area

Package Information



SYMBOL	MIN	NOM	MAX
A	4.80	5.00	5.20
A1	2.29	2.41	2.54
A2	1.90	2.00	2.10
b	1.10	1.20	1.30
b1	1.91	2.10	2.20
b2	2.92	3.10	3.20
c	0.50	0.60	0.70
D	20.80	21.07	21.34
D1	17.43	17.63	17.83
E	15.75	15.94	16.13
E1	13.06	13.26	13.46
E2	4.32	4.58	4.83
e	5.45 BSC		
L	19.81	20.19	20.57
L1	3.81	4.07	4.32
phi P	3.55	3.60	3.65
Q	5.59	5.90	6.20
S	6.15 BSC		

NOTE

1. THESE DIMENSION DO NOT INCLUDE MOLD PROTRUSION

Packing Information

Inner Box

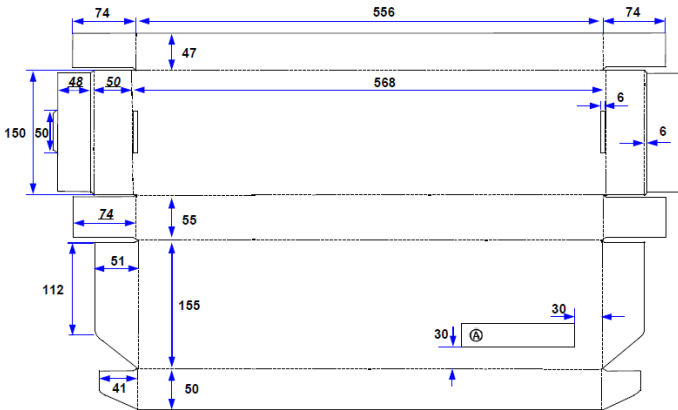

PART ID PMXXXXXXXXLX_G	PKG Type XX-XXXX-XX
LOT No. XXXXXXXXXXXXXX	QTY X,XXX ea
DATE: XXXX.XX.XX	

Outer Box

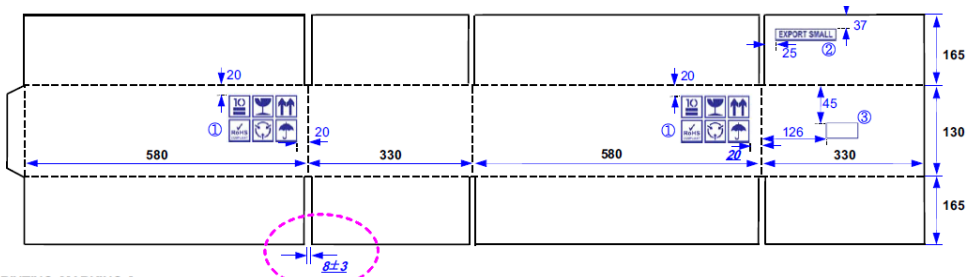

[BOX PRINTING MARKING]



MARKING SIZE (Each Symbol 30*30)
COLOR (DARK BLUE)

- ② EXPORT SMALL
MARKING SIZE (112*20)
COLOR (DARK BLUE)
- ③
LABEL MARKING SIZE (75*35)
COLOR (DARK BLUE)

[NOTE]

1. MATERIAL : KLB175*K180*KLB175*K180*KLB175
(SUK175*K200*K200*K200*SUK175)
2. NAIL QTY : 3 PCS
3. PRINTING TOLERANCE : MARKING SIZE(±3)
MARKING POSITION(±5)

PART ID : PMXXXXXXXXLX_G
LOT NO : XXXXXXXXXXXXX
QTY : XX,XXXX ea
DATE : XXXX.XX.XX

Notes

- A. Specifications mentioned in this publication are subject to change without notice.
- B. Before you use our Products, please contact our sales representative and verify the latest specifications.
- C. In order to prevent personal injury or fire arising from failure, please take safety measures such as complying with the derating characteristics, implementing redundant and fire prevention designs, and utilizing backups and fail-safe procedures.
- D. YES POWERTECHNIX shall have no responsibility for any damages arising out of the use of our products beyond the rating specified by YES POWERTECHNIX.
- E. The technical information specified herein is intended only to show the typical functions of and examples of application circuits for the Products.
- F. YES POWERTECHNIX does not grant you, explicitly or implicitly, any license to use or exercise intellectual property or other rights held by YES POWERTECHNIX or any other parties.
- G. YES POWERTECHNIX shall have no responsibility whatsoever for any dispute arising out of the use of such technical information.
- H. Please use the Products in accordance with any applicable environmental laws and regulations, such as the RoHS Directive.
- I. YES POWERTECHNIX shall have no responsibility for any damages or losses resulting non-compliance with any applicable laws or regulations.
- J. This document, in part or in whole, may not be reprinted or reproduced without prior consent of YES POWERTECHNIX.

