



Temperature protection device

## Chip NTC thermistor

Automotive grade:Corresponding to 125,150,175°C

# NTCG series

---

<b>NTCG 0603</b>	<b>JIS 0603 [EIA 0201]</b>
<b>NTCG 1005</b>	<b>JIS 1005 [EIA 0402]</b>
<b>NTCG 1608</b>	<b>JIS 1608 [EIA 0603]</b>
<b>NTCG 2012</b>	<b>JIS 2012 [EIA 0805]</b>

---

## REMINDERS FOR USING THESE PRODUCTS

Before using these products, be sure to request the delivery specifications.

### SAFETY REMINDERS

Please pay sufficient attention to the warnings for safe designing when using this products.

 **REMINDERS**

Please pay careful attention to the precautions and follow safe designing practices when using these products.

Incorrect usage may lead to destroyed NTC thermistors and damages or malfunctions with the devices used.

- Please use them within the ranges of the ratings and performance provided in the catalog and delivery specifications upon confirming the environments where they are to be used and installed.
- Do not use them outside the operating temperature range.
- Do not use them with the ratings or maximum permissible power levels exceeded.
- Do not quickly apply 5mW or more of load with the constant-voltage power supply in the NTC thermistor as this may lead to staying in thermal runaway mode or the red-shortening of chips.
- Please be cautious of the applied voltage in thermistors as instruments may malfunction with the lowering of resistance due to self heating.
- With instruments that consumers can touch the thermistors with their hands, please carefully warn them not to touch the thermistors.
- Store them in locations where the temperature is 10°C to +40°C and the relative humidity is 75% or below, avoid environments where there are sudden changes in temperatures, direct sunlight, corrosive gas, grit, or dust, and keep them packed in a manner where no loading stress is applied in order to avoid deterioration and damage. (please use them within six months.)
- When sealing thermistors, please do so upon first considering the type, quantity, hardening conditions, and adhesiveness of the sealing material and confirming its reliability.
- Avoid powerful vibrations, impact (such as by dropping), pressure, etc. on thermistors that exceed the prescribed levels.
- Do not use them for long periods of time in environments with a relative humidity of over 85%. (this excludes cases where countermeasures have been taken.)
- Do not use them in the following environments. (this excludes cases where countermeasures have been taken.)
  - Corrosive gases (Cl<sub>2</sub>, NH<sub>3</sub>, SO<sub>x</sub>, NO<sub>x</sub>, etc.)
  - Environments with highly conductive substances (electrolytes, water, saltwater, etc.)
  - Environments with acid, alkali, or organic solvents
  - Dusty areas
- Please observe the following precautions when attaching them to substrates as failure to do so may result in destruction or malfunction.
  - Do not let the substrates get warped or twisted at any time during the soldering.
  - The landing size must be even on both the left and right sides.
  - Do not use items that have been dropped or detached.
  - Do not allow the adherence of more solder than needed.
- Reflow mounting is recommended with NTC thermistors, and not flow (dip) mounting.
- Attaching or making corrections with a soldering iron is not recommended as it can lead to troubles such as significant distorting due to thermal shock or cracking. If a soldering iron must be used, it should be 30W or below with the temperature of the tip at 350°C or below, and at a maximum of 5 seconds of soldering time. Also, do not let the tip of the soldering iron come in direct contact with the chips.
- Please use a substance such as resin that does not generate hydrogen (H<sub>2</sub>) when forming insulation film over chips.
- Please contact our sales offices when considering the use of the products listed on this catalog for applications, whose performance and/or quality require a more stringent level of safety or reliability, or whose failure, malfunction or trouble could cause serious damage to society, person or property ('specific uses' such as automobiles, airplanes, medical instruments, nuclear devices, etc.) as well as when considering the use for applications that exceed the range and conditions of this catalog.

Please note that we are not responsible for any damages or losses incurred resulting from the use of these products that exceeds the range and conditions of this catalog or specific uses.

Please take appropriate measures such as acquiring protective circuits and devices that meet the uses, applications, and conditions of the instruments and keeping backup circuits.

# NTC Thermistors

Automotive grade:Corresponding to 125,150,175°C

Product compatible with RoHS directive  
Compatible with lead-free solders  
AEC-Q200

## Overview of the NTCG series

### CHARACTERISTICS OF NTC THERMISTORS

NTC(Negative Temperature Coefficient) thermistors are manufactured from sintered metal oxides. Each thermistor consists of a combination of two to four of the following materials: manganese, nickel, cobalt and copper. NTC thermistors are semiconductor resistors that exhibit decreasing resistance characteristics with increasing temperature. TDK thermistors have low thermal time constants which result in extremely high rates of resistance change to accurately track the temperature.

### FEATURES OF NTCG SERIES

- 125°C compatible lineup
- 150°C compatible lineup
- 175°C compatible lineup (guaranteed separately)
- AEC-Q200 compliant.

Fig.1 R-T Curve : 10kohm@25°C

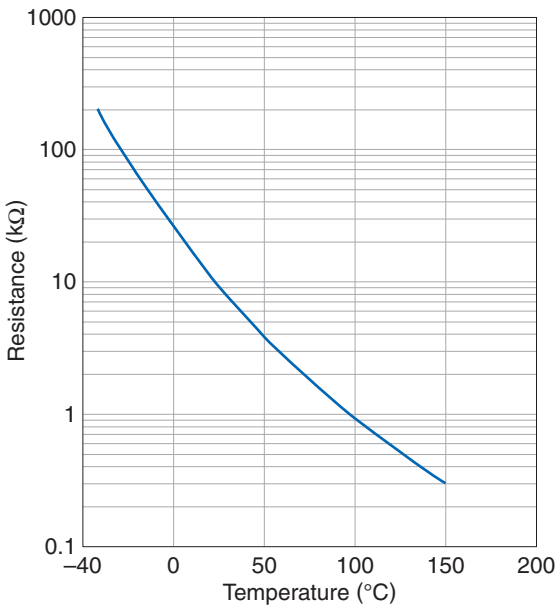
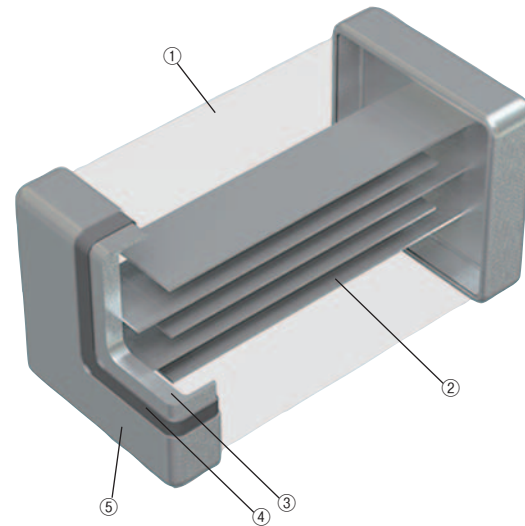

Fig.2 Internal structure of the multilayer chip Thermistors



No.	Name
①	Semiconductor ceramics
②	Internal electrode (Pd)
③	Ag
④	Terminal electrode Ni
⑤	Sn

○ RoHS Directive Compliant Product: See the following for more details.<https://product.tdk.com/info/en/environment/rohs/index.html>

⚠ Please be sure to request delivery specifications that provide further details on the features and specifications of the products for proper and safe use. Please note that the contents may change without any prior notice due to reasons such as upgrading.

# NTC Thermistors

Product compatible with RoHS directive

Compatible with lead-free solders

AEC-Q200

Automotive grade:Corresponding to 125,150,175°C

## Overview of the NTCG series

### PART NUMBER CONSTRUCTION

Series name	Structural classification	shapes and dimensions Code (mm)		B constant*	B constant tolerance (%)		Nominal resistance (Ω)		Nominal resistance tolerance (%)		Packaging style		TDK internal code	
NTC thermistor	G	06	0603		F	±1	300	30	D	±0.5	T	Taping	DS	125°C vehicle response B constant: 25/85°C
		10	1005		H	±3	101	100	F	±1	B	Bulk	DSX	125°C vehicle response B constant: 25/50°C
		16	1608				102	1000 (1kΩ)	H	±3			1S	150°C vehicle response B constant: 25/85°C
		20	2012				103	10000 (10kΩ)	J	±5			1SX	150°C vehicle response B constant: 25/50°C
													1H	175°C vehicle response B constant: 25/85°C
													1HX	175°C vehicle response B constant: 25/50°C

\* B constant

B constant(K)			
2A	2000 to 2050	3A	3000 to 3050
2B	2051 to 2100	3B	3051 to 3100
2C	2101 to 2150	3C	3101 to 3150
2E	2201 to 2250	3E	3201 to 3250
2F	2251 to 2300	3F	3251 to 3300
2J	2401 to 2450	3J	3401 to 3450
2K	2451 to 2500	3K	3451 to 3500
2L	2501 to 2550	3L	3501 to 3550
2N	2601 to 2650	3N	3601 to 3650
2Q	2701 to 2750	3Q	3701 to 3750
2S	2801 to 2850	3S	3801 to 3850
4A	4000 to 4050	4B	4051 to 4100
4C	4101 to 4150	4E	4201 to 4250
4F	4251 to 4300	4J	4401 to 4450
4K	4451 to 4500	4L	4501 to 4550
4N	4601 to 4650	4Q	4701 to 4750
4S	4801 to 4850		

The B constant indicates the magnitude of a change in a zero-load resistance value to a temperature, and is obtained based on arbitrary two temperatures in resistance-to-temperature characteristics.

#### B constant calculation formula

$$B = \frac{\ln R_1 - \ln R_2}{(1/T_1) - (1/T_2)}$$

B: B constant (K)

T1:Arbitrary temperature (K)

T2:Arbitrary temperature different from T1 (K)

R1:Zero-load resistance value at temperature T1(Ω)

R2:Zero-load resistance value at temperature T2(Ω)

Each temperature is measured in absolute temperature. 0°C=273.15K

Shape symbol (JIS)	Dimensions in mm			
	L	W	T	B
0603	0.60±0.03	0.30±0.03	0.30±0.03	0.1min
1005	1.00±0.05	0.50±0.05	0.50±0.05	0.1min
1608	1.60±0.10	0.80±0.10	0.80±0.10	0.2min
2012	2.00±0.20	1.25±0.20	0.70±0.20	0.2min

Please be sure to request delivery specifications that provide further details on the features and specifications of the products for proper and safe use.  
Please note that the contents may change without any prior notice due to reasons such as upgrading.

# NTC Thermistors

Product compatible with RoHS directive

Compatible with lead-free solders

AEC-Q200

Automotive grade: Corresponding to 125,150,175°C

## Overview of the NTCG series

### ■ RATINGS 125°C RESPONSE COUNTERPARTS

Size	mm	0603	1005	1608	2012
Maximum rated power (25°C) Asteris*1	mW	100	100	100	200
Dissipation factors (25°C) *2	mW/°C   mW/K	1	1	1	2

### ■ RATINGS 150°C RESPONSE COUNTERPARTS

Size	mm	1005	1608	2012
Maximum rated power (25°C) Asteris*1	mW	125	125	250
Dissipation factors (25°C) *2	mW/°C   mW/K	1	1	2

### ■ RATINGS 175°C RESPONSE COUNTERPARTS

Size	mm	1005	1608
Maximum rated power (25°C) Asteris*1	mW	150	150
Dissipation factors (25°C) *2	mW/°C   mW/K	1	1

\*1 Maximum rated power: Maximum power: at rated temperature (25°C), maximum power that can be applied continuously

\*2 Dissipation factors: powered that it is equivalent that be increased in self-heating by load power thermistor at 1°C temperature

# NTC Thermistors

Product compatible with RoHS directive

Compatible with lead-free solders

AEC-Q200

Automotive grade: Corresponding to 125,150,175°C

## NTCG series 0603 type

### SHAPE & DIMENSIONS

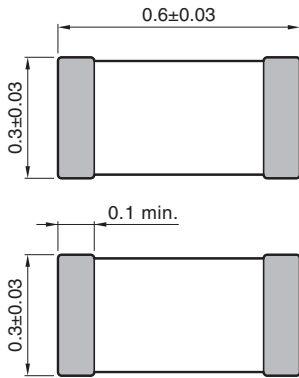

Electrode material  
Internal: Pd  
External: Ag/Ni/Sn

Dimensions in mm

### RECOMMENDED LAND PATTERN

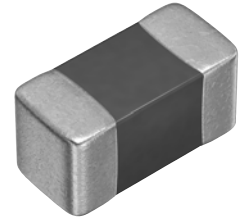
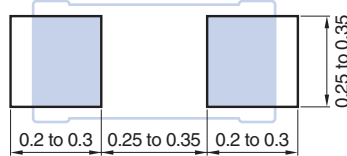

### 125°C RESPONSE COUNTERPARTS (OPERATING TEMPERATURE RANGE : -40 to 125°C)

Part No.	Resistance [25°C] (Ω)	Resistance tolerance	B constant [25/50°C] (K)	B constant [25/75°C] (K)	B constant [25/85°C] (K)	B constant [25/100°C] (K)	B constant tolerance	Permissible operating current [25°C] (mA)
<a href="#">NTCG063JF103FTDS</a>	10,000	±1%	3380	3422	3435	3453	±1%	0.31
<a href="#">NTCG064EF104FTDSX</a>	100,000	±1%	4250	4293	4308	4327	±1%	0.10

# NTC Thermistors

Product compatible with RoHS directive

Compatible with lead-free solders

AEC-Q200

Automotive grade: Corresponding to 125,150,175°C

## NTCG series 1005 type

### SHAPE & DIMENSIONS

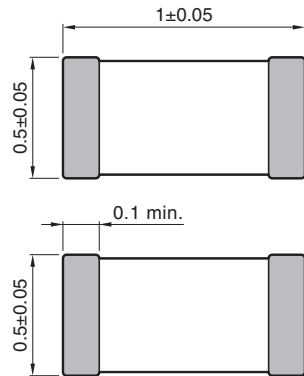

Electrode material  
Internal: Pd  
External: Ag/Ni/Sn

Dimensions in mm

### RECOMMENDED LAND PATTERN

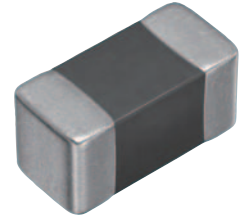
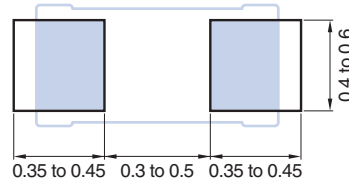

### 125°C RESPONSE COUNTERPARTS (OPERATING TEMPERATURE RANGE : -40 to 125°C)

Part No.	Resistance [25°C] (Ω)	Resistance tolerance	B constant [25/50°C] (K)	B constant [25/75°C] (K)	B constant [25/85°C] (K)	B constant [25/100°C] (K)	B constant tolerance	Permissible operating current [25°C] (mA)
<a href="#">NTCG103JF103JTDS</a>	10,000	±5%	3380	3422	3435	3453	±1%	0.31
<a href="#">NTCG103JF103HTDS</a>	10,000	±3%	3380	3422	3435	3453	±1%	0.31
<a href="#">NTCG103JF103FTDS</a>	10,000	±1%	3380	3422	3435	3453	±1%	0.31
<a href="#">NTCG103JX103DTDS</a>	10,000	±0.5%	3380	3422	3435	3453	±0.7%	0.31
<a href="#">NTCG104LH223JTDS</a>	22,000	±5%	4485	4533	4550	4573	±3%	0.21
<a href="#">NTCG104LH473JTDS</a>	47,000	±5%	4485	4533	4550	4573	±3%	0.14
<a href="#">NTCG104BF473JTDSX</a>	47,000	±5%	4050	4098	4114	4137	±1%	0.14
<a href="#">NTCG104BF473HTDSX</a>	47,000	±3%	4050	4098	4114	4137	±1%	0.14
<a href="#">NTCG104BF473FTDSX</a>	47,000	±1%	4050	4098	4114	4137	±1%	0.14
<a href="#">NTCG104BF683FTDSX</a>	68,000	±1%	4085	4134	4150	4172	±1%	0.12
<a href="#">NTCG104LH104JTDS</a>	100,000	±5%	4485	4533	4550	4573	±3%	0.10
<a href="#">NTCG104EF104HTDSX</a>	100,000	±3%	4250	4293	4308	4327	±1%	0.10
<a href="#">NTCG104EF104FTDSX</a>	100,000	±1%	4250	4293	4308	4327	±1%	0.10
<a href="#">NTCG104ED104DTDSX</a>	100,000	±0.5%	4250	4293	4308	4327	±0.5%	0.10
<a href="#">NTCG104LH154JTDS</a>	150,000	±5%	4485	4533	4550	4573	±3%	0.05

### 150°C RESPONSE COUNTERPARTS (OPERATING TEMPERATURE RANGE : -40 to 150°C)

Part No.	Resistance [25°C] (Ω)	Resistance tolerance	B constant [25/50°C] (K)	B constant [25/75°C] (K)	B constant [25/85°C] (K)	B constant [25/100°C] (K)	B constant tolerance	Permissible operating current [25°C] (mA)
<a href="#">NTCG103JF103JT1S</a>	10,000	±5%	3380	3422	3435	3453	±1%	0.31
<a href="#">NTCG103JF103HT1S</a>	10,000	±3%	3380	3422	3435	3453	±1%	0.31
<a href="#">NTCG103JF103FT1S</a>	10,000	±1%	3380	3422	3435	3453	±1%	0.31
<a href="#">NTCG103JX103DT1S</a>	10,000	±0.5%	3380	3422	3435	3453	±0.7%	0.31
<a href="#">NTCG104LH473JT1S</a>	47,000	±5%	4485	4533	4550	4573	±3%	0.14
<a href="#">NTCG104BF473JT1SX</a>	47,000	±5%	4050	4098	4114	4137	±1%	0.14
<a href="#">NTCG104BF473HT1SX</a>	47,000	±3%	4050	4098	4114	4137	±1%	0.14
<a href="#">NTCG104BF473FT1SX</a>	47,000	±1%	4050	4098	4114	4137	±1%	0.14
<a href="#">NTCG104LH104JT1S</a>	100,000	±5%	4485	4533	4550	4573	±3%	0.10
<a href="#">NTCG104EF104HT1SX</a>	100,000	±3%	4250	4293	4308	4327	±1%	0.10
<a href="#">NTCG104EF104FT1SX</a>	100,000	±1%	4250	4293	4308	4327	±1%	0.10
<a href="#">NTCG104ED104DT1SX</a>	100,000	±0.5%	4250	4293	4308	4327	±0.5%	0.10

⚠ Please be sure to request delivery specifications that provide further details on the features and specifications of the products for proper and safe use.  
Please note that the contents may change without any prior notice due to reasons such as upgrading.

# NTC Thermistors

Automotive grade:Corresponding to 125,150,175°C

Product compatible with RoHS directive  
Compatible with lead-free solders  
AEC-Q200

## NTCG series 1005 type

### SHAPE & DIMENSIONS

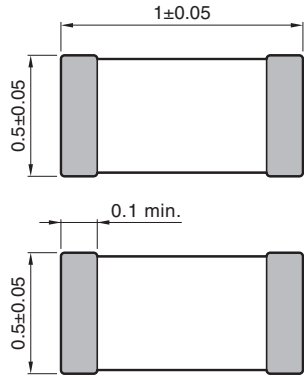

Electrode material  
Internal: Pd  
External: Ag/Ni/Sn  
Dimensions in mm

### RECOMMENDED LAND PATTERN

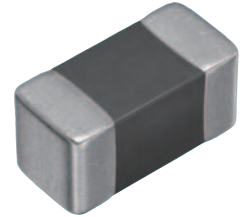
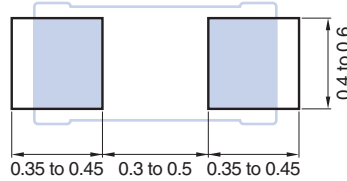

### 175°C RESPONSE COUNTERPARTS (OPERATING TEMPERATURE RANGE : -40 to 175°C)

Part No.	Resistance [25°C] (Ω)	Resistance tolerance	B constant [25/50°C] (K)	B constant [25/75°C] (K)	B constant [25/85°C] (K)	B constant [25/100°C] (K)	B constant tolerance	Permissible operating current [25°C] (mA)
<a href="#">NTCG103JF103FT1H</a>	10,000	±1%	3380	3422	3435	3453	±1%	0.31
<a href="#">NTCG104KF104FT1H</a>	100,000	±1%	4419	4468	4485	4509	±1%	0.10

\* Solder joint is not guaranteed. It is guaranteed as a single part.

⚠ Please be sure to request delivery specifications that provide further details on the features and specifications of the products for proper and safe use. Please note that the contents may change without any prior notice due to reasons such as upgrading.



# NTC Thermistors

Product compatible with RoHS directive

Compatible with lead-free solders

AEC-Q200

Automotive grade: Corresponding to 125,150,175°C

## NTCG series 1608 type

### SHAPE & DIMENSIONS

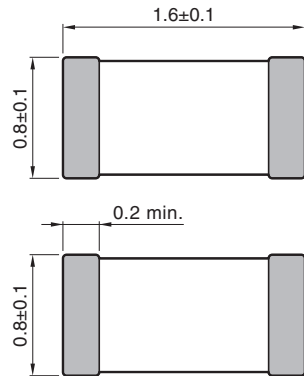

Electrode material  
Internal: Pd  
External: Ag/Ni/Sn

### RECOMMENDED LAND PATTERN

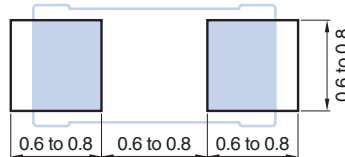

Dimensions in mm

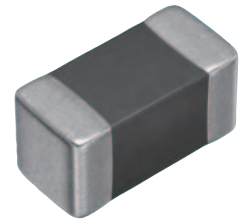

### 125°C RESPONSE COUNTERPARTS (OPERATING TEMPERATURE RANGE : -40 to 125°C)

Part No.	Resistance [25°C] (Ω)	Resistance tolerance	B constant [25/50°C] (K)	B constant [25/75°C] (K)	B constant [25/85°C] (K)	B constant [25/100°C] (K)	B constant tolerance	Permissible operating current [25°C] (mA)
<a href="#">NTCG163EH101HTDS</a>	100	±3%	3244	3249	3250	3251	±3%	3.16
<a href="#">NTCG164BH222JTDS</a>	2,200	±5%	4096	4100	4100	4100	±3%	0.67
<a href="#">NTCG164BH472JTDS</a>	4,700	±5%	4067	4092	4100	4110	±3%	0.46
<a href="#">NTCG163JF103HTDS</a>	10,000	±3%	3380	3422	3435	3453	±1%	0.31
<a href="#">NTCG163JF103FTDS</a>	10,000	±1%	3380	3422	3435	3453	±1%	0.31
<a href="#">NTCG163JX103DTDS</a>	10,000	±0.5%	3380	3422	3435	3453	±0.7%	0.31
<a href="#">NTCG164BH103JTDS</a>	10,000	±5%	4067	4092	4100	4110	±3%	0.31
<a href="#">NTCG164LH223JTDS</a>	22,000	±5%	4485	4533	4550	4573	±3%	0.21
<a href="#">NTCG164LH473JTDS</a>	47,000	±5%	4485	4533	4550	4573	±3%	0.14
<a href="#">NTCG164LH473HTDS</a>	47,000	±3%	4485	4533	4550	4573	±3%	0.14
<a href="#">NTCG164BF473FTDSX</a>	47,000	±1%	4050	4098	4114	4137	±3%	0.14
<a href="#">NTCG164LH104JTDS</a>	100,000	±5%	4485	4533	4550	4573	±3%	0.10
<a href="#">NTCG164LH104HTDS</a>	100,000	±3%	4485	4533	4550	4573	±3%	0.10
<a href="#">NTCG164KF104FTDS</a>	100,000	±1%	4419	4468	4485	4509	±1%	0.10
<a href="#">NTCG164LH154JTDS</a>	150,000	±5%	4485	4533	4550	4573	±3%	0.08
<a href="#">NTCG164QF474JTDS</a>	470,000	±5%	4632	4698	4720	4749	±1%	0.04
<a href="#">NTCG164QF474HTDS</a>	470,000	±3%	4632	4698	4720	4749	±1%	0.04

### 150°C RESPONSE COUNTERPARTS (OPERATING TEMPERATURE RANGE : -40 to 150°C)

Part No.	Resistance [25°C] (Ω)	Resistance tolerance	B constant [25/50°C] (K)	B constant [25/75°C] (K)	B constant [25/85°C] (K)	B constant [25/100°C] (K)	B constant tolerance	Permissible operating current [25°C] (mA)
<a href="#">NTCG163JF103HT1S</a>	10,000	±3%	3380	3422	3435	3453	±1%	0.31
<a href="#">NTCG163JF103FT1S</a>	10,000	±1%	3380	3422	3435	3453	±1%	0.31
<a href="#">NTCG163JX103DT1S</a>	10,000	±0.5%	3380	3422	3435	3453	±0.7%	0.31
<a href="#">NTCG164LH473JT1S</a>	47,000	±5%	4485	4533	4550	4573	±3%	0.14
<a href="#">NTCG164LH473HT1S</a>	47,000	±3%	4485	4533	4550	4573	±3%	0.14
<a href="#">NTCG164BF473FT1SX</a>	47,000	±1%	4050	4098	4114	4137	±3%	0.14
<a href="#">NTCG164LH104JT1S</a>	100,000	±5%	4485	4533	4550	4573	±3%	0.10
<a href="#">NTCG164LH104HT1S</a>	100,000	±3%	4485	4533	4550	4573	±3%	0.10
<a href="#">NTCG164KF104FT1S</a>	100,000	±1%	4419	4468	4485	4509	±1%	0.10
<a href="#">NTCG164QF474JT1S</a>	470,000	±5%	4632	4698	4720	4749	±1%	0.04
<a href="#">NTCG164QF474HT1S</a>	470,000	±3%	4632	4698	4720	4749	±1%	0.04

⚠ Please be sure to request delivery specifications that provide further details on the features and specifications of the products for proper and safe use.  
Please note that the contents may change without any prior notice due to reasons such as upgrading.

# NTC Thermistors

Product compatible with RoHS directive  
Compatible with lead-free solders  
AEC-Q200

Automotive grade: Corresponding to 125,150,175°C

## NTCG series 1608 type

### SHAPE & DIMENSIONS

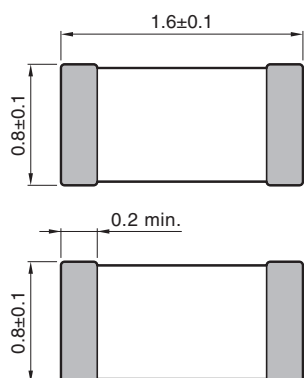

Electrode material  
Internal: Pd  
External: Ag/Ni/Sn

Dimensions in mm

### RECOMMENDED LAND PATTERN

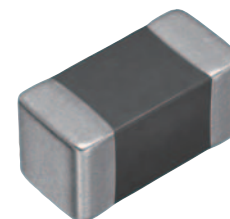
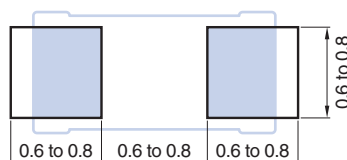

### 175°C RESPONSE COUNTERPARTS (OPERATING TEMPERATURE RANGE : -40 to 175°C)

Part No.	Resistance [25°C] (Ω)	Resistance tolerance	B constant [25/50°C] (K)	B constant [25/75°C] (K)	B constant [25/85°C] (K)	B constant [25/100°C] (K)	B constant tolerance	Permissible operating current [25°C] (mA)
<a href="#">NTCG163JF103FT1H</a>	10,000	±1%	3380	3422	3435	3453	±1%	0.31
<a href="#">NTCG164KF104FT1H</a>	100,000	±1%	4419	4468	4485	4509	±1%	0.10

\* Solder joint is not guaranteed. It is guaranteed as a single part.

# NTC Thermistors

Product compatible with RoHS directive  
Compatible with lead-free solders  
AEC-Q200

Automotive grade: Corresponding to 125,150,175°C

## NTCG series 2012 type

### SHAPE & DIMENSIONS

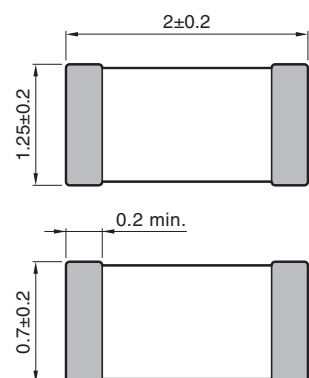

Electrode material  
Internal: Pd  
External: Ag/Ni/Sn

### RECOMMENDED LAND PATTERN

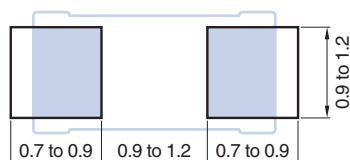

Dimensions in mm

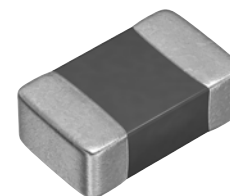

### 125°C RESPONSE COUNTERPARTS (OPERATING TEMPERATURE RANGE : -40 to 125°C)

Part No.	Resistance [25°C] (Ω)	Resistance tolerance	B constant [25/50°C] (K)	B constant [25/75°C] (K)	B constant [25/85°C] (K)	B constant [25/100°C] (K)	B constant tolerance	Permissible operating current [25°C] (mA)
<a href="#">NTCG203NH103JTDS</a>	10,000	±5%	3590	3635	3650	3670	±3%	0.44
<a href="#">NTCG204AH473JTDS</a>	47,000	±5%	3930	3982	4000	4032	±3%	0.20
<a href="#">NTCG204CH104JTDS</a>	100,000	±5%	4085	4134	4150	4172	±3%	0.14

### 150°C RESPONSE COUNTERPARTS (OPERATING TEMPERATURE RANGE : -40 to 150°C)

Part No.	Resistance [25°C] (Ω)	Resistance tolerance	B constant [25/50°C] (K)	B constant [25/75°C] (K)	B constant [25/85°C] (K)	B constant [25/100°C] (K)	B constant tolerance	Permissible operating current [25°C] (mA)
<a href="#">NTCG203NH103JT1S</a>	10,000	±5%	3590	3635	3650	3670	±3%	0.44
<a href="#">NTCG204AH473JT1S</a>	47,000	±5%	3930	3982	4000	4032	±3%	0.20
<a href="#">NTCG204CH104JT1S</a>	100,000	±5%	4085	4134	4150	4172	±3%	0.14

# NTC Thermistors

Product compatible with RoHS directive  
Compatible with lead-free solders  
AEC-Q200

Automotive grade:Corresponding to 125,150,175°C

## NTCG series RT table

### R-T TABLE ACQUISITION PROCEDURE

1. Access the top page of the TDK chip NTC thermistor (protective device)  
<https://product.tdk.com/info/en/products/protection/temperature/chip-ntc-thermistor/index.html>





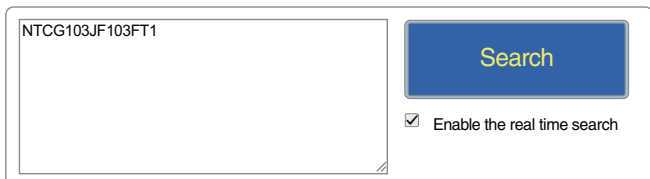

2. Click [Search by Part No.]  
[https://product.tdk.com/en/search/protection/temperature/chip-ntc-thermistor/part\\_no/](https://product.tdk.com/en/search/protection/temperature/chip-ntc-thermistor/part_no/)

3. Enter the product name you want in the RT table in the box and click the Search button.  
( Example: NTCG103JF103FT1 )







- Wildcard and Multiple Part number.**
- Question mark (?) and asterisk (\*) can be used as wildcard characters. The question mark (?) matches any single character, and the asterisk (\*) matches any sequence of characters.
  - Enter only one part number per line. Up to 50 part numbers can be searched simultaneously.
  - A part number search is normally performed using a prefix search. If you wish to use a suffix search, enter an exclamation mark (!) at the end of the Part No.

4. Click the displayed product name.  
( Example: NTCG103JF103FT1 )

Check	Catalog / Data Sheet ?	Images	Part No. ?	Distributor Inventory	Brand	Apps.	Feature
<input type="checkbox"/>							
<input type="checkbox"/>			 NTCG103JF103FT1	<a href="#">Buy Now</a>	TDK		125°C UL
<input type="checkbox"/>			 NTCG103JF103FT1S	<a href="#">Buy Now</a>	TDK		150°C AEC-Q200

5. Individual pages are displayed and click the RT table in the "Document" on the right side bar.

Documents
 Catalog
 RoHS Certificate
 SVHC/REACH Certificate
 Selection Guide
 RT Sheet

6. You can download the csv file in the 1°C step of the RT table for the product.

 Please be sure to request delivery specifications that provide further details on the features and specifications of the products for proper and safe use. Please note that the contents may change without any prior notice due to reasons such as upgrading.

# NTC Thermistors

Automotive grade: Corresponding to 125,150,175°C

Product compatible with RoHS directive  
Compatible with lead-free solders  
AEC-Q200

## Attention in the board design

### BOARD DESIGN

When attached to NTC substrate thermistor, amount of silver used (fillet size) has direct impact on NTC thermistor after mounting. Thus, sufficient consideration is necessary.

#### Set of land dimensions

(1) As the stress rises in the NTC thermistor owing to the increase in silver, breakage and cracks will occur. Cause including crack, as caution on board land design, configure the shape and dimensions so that the amount of silver is appropriate.

If you installed 2 or more parts in the Common Land, separated by a solder resist and special land of each component.

Dimensions shape

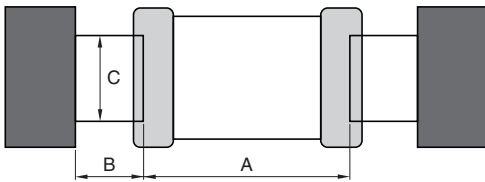

Shape symbol	Symbol		
	A	B	C
0603	0.25 to 0.35	0.20 to 0.30	0.25 to 0.35
1005	0.30 to 0.50	0.35 to 0.45	0.40 to 0.60
1608	0.60 to 0.80	0.60 to 0.80	0.60 to 0.80
2012	0.90 to 1.20	0.70 to 0.90	0.90 to 1.20

(2) When peak levels panning-at soldering is excessive, by solder contraction stress, mechanical-thermal stress causes a Yasuku chip crack.

In addition, when the peak level is underestimated, terminal electrode fixed strength is insufficient. This causes chip dropouts and may affect circuit reliability.

Representative example of the panning of peak levels is shown in the following.

#### Recommended silver dose

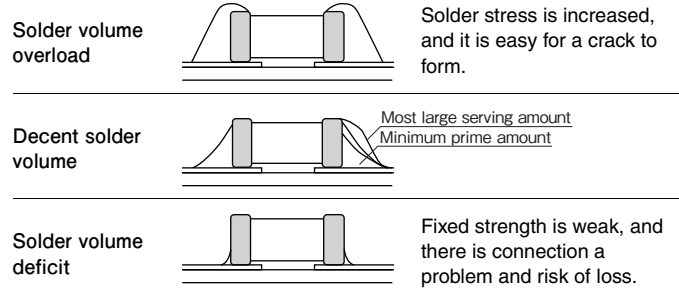

#### Case and suggested protocol want to avoid

Example	Cases to avoid	Improvement example (land division)
Lead wire and land of part discrete doubles up		
Arrangements in the vicinity		
Arrangements of chip component's companion		

# NTC Thermistors

Automotive grade: Corresponding to 125,150,175°C

Product compatible with RoHS directive  
Compatible with lead-free solders  
AEC-Q200

## Attention in the board design

### Arrangements of components

(1) I was based on camber of substrate and suggested protocol of NTC thermistor arrangement, as stress does not join to the utmost is shown in following.

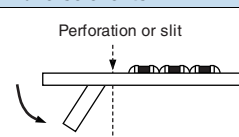
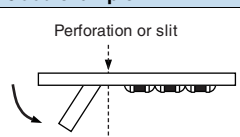
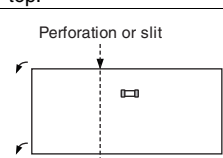
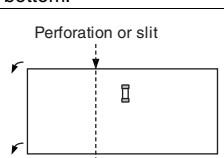
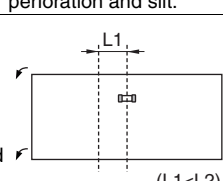
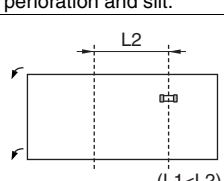
	Substrate for flexural stress Adverse events	Substrate for flexural stress Good example
Direction of surface solder		
	Solder the mountain fold as a top.	Solder the mountain fold as a bottom.
Chip arrangements (direction)		
	Mounted vertically to the perforation and slit.	Mounted horizontally to the perforation and slit.
Distance from perforation and slit portion		
	(L1 < L2) Close location is disadvantageous of perforation and slit.	(L1 < L2) It is an advantage so distant location away places the perforation and slit.

(2) In payment near by board, depending on mount position of NTC PTC, as mechanical stress varies, please refer to the following diagram.

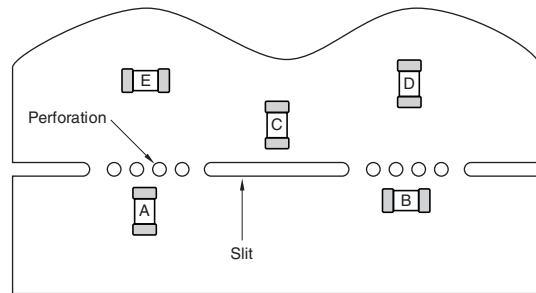

The order of A > B = C > D > E eases the stress.

⚠ Please be sure to request delivery specifications that provide further details on the features and specifications of the products for proper and safe use. Please note that the contents may change without any prior notice due to reasons such as upgrading.

# NTC Thermistors

Automotive grade: Corresponding to 125, 150, 175°C

Product compatible with RoHS directive  
Compatible with lead-free solders  
AEC-Q200

## Attention on the mounting

### APPLICATION TO BOARD

#### Mounting head pressure

Under suction nozzle if dead point too, during implementation, excessive force joins of NTC thermistor low, as cause causes of crack, please use with reference to something about following.

- 1) Being set to top surface of substrate so that under suction nozzle as for dead center, substrate does not bend back, and adjust, please.
- 2) Nozzle pressure at implementation is 1N – 3N in static load, please.
- 3) Substrate fixes up back surface of substrate with support pin in impact of suction nozzle to wely deflection to the utmost, and substrate hold deflection, please.

A representative example is shown in the following.

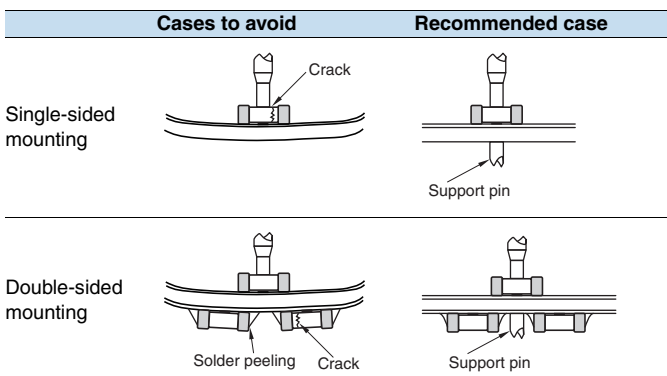

Mechanical shock that, if positioning your nail to wear, ragged edge of positionings, participates in NTC thermistor are locally, and NTC thermistor, as there is possibility of crack generated, cut the closed positioning, and maintenance and inspection, and, exchange of manage dimensions and position nail periodically, please.

### SOLDERING

Significant impact is possible on the performance of NTC thermistor, flux checks something about follow, please use.

- (1) Flux uses one with 0.1wt % (Cl conversion) or less halide substance contains amounts, please. In addition, do not do this with strongly acidic objects.
- (2) Flux during is soldered (2) NTC substrate thermistor is applied the smallest amount necessary, please.
- (3) If Used soluble flux, perform thorough wash particularly, please.

Reflow temperature profile

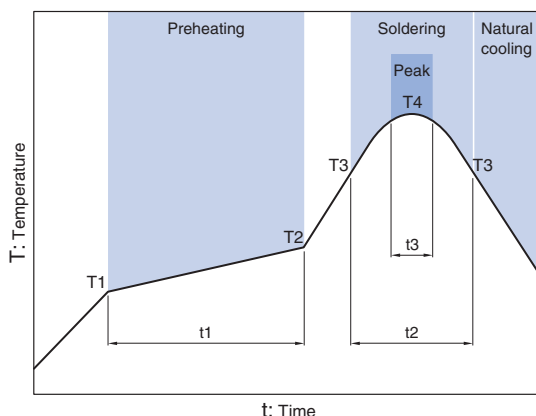

Item	Specification	
	for eutectic mixture solder	For lead-free solder
Preheating temperature	160 to 180°C	150 to 180°C
Solder melting temperature	200°C	230°C
Maximum temperature	240°C max.	260°C max.
Preheating time	100s max.	120s max.
Time to reach higher than the solder melting temperature	30s max.	40s max.
number of possible reflow cycles	2 max.	2 max.

### SOLDERING IRON

(1) The tip temperature and also by (1) types of soldering irons, the size of the substrate, and the geometry of the land pattern. Being earlier, but when as there is possibility that crack occurs in the heat anderson impaction, point soldering iron temperature is high, please do solder work within the following conditions.

Temperature of iron tips (°C)	Wattage (W)	Pallet point shape (mm)	Soldering time (Second)	Frequency
350max.	20max.	ø3.0max.	5 max.	Within each terminal once (Within total of twice)

(2) Direct iron tip is in contact with the (2) NTC thermistor body, and the strain owing to thermal shock in particular grows even if a crack is generated. Therefore, please do not touch it directly to the terminal electrodes.

Please be sure to request delivery specifications that provide further details on the features and specifications of the products for proper and safe use. Please note that the contents may change without any prior notice due to reasons such as upgrading.

# NTC Thermistors

Automotive grade: Corresponding to 125,150,175°C

## Attention after mounting

### CLEANING

- (1) If cleaning liquid is inappropriate, residues and other foreign body of fluxes builds up on NTC PTC surface, and can degrade the performance of NTC thermistor (particularly the insulation resistance).
- (2) Wash conditions may compromise performance of NTC thermistor if they are improper (wash due, wash excess).

#### 2-1) For wash due

- (a) By substance of a system in flux residue halide, metal including terminal electrodes may experience corrosion.
- (b) Substance of a system in flux residue halide builds up on NTC PTC surface, and reduces the insulation resistance.
- (c) Soluble flux makes comparisons of colophony series flux, and there is event with trends of significant (1) and (2).

#### 2-2) For excess wash

- (1) Owing to lavage, NTC PTC surface deteriorates, and reduces performance of NTC thermistor.
- (2) In ultrasonography, when output is passed, substrate resonates size, and crack occurs in body and sprang of NTC thermistor in vibration of substrate. Since this may reduce the strength of the terminal electrode, please note the following conditions.
- Output    Ultrasound output  
 Frequency    Ultrasonic frequency  
 Cleaning time    Ultrasound cleaning time

2-3) Concentration including halogen that when cleaning liquid to pollution, when you released is higher, and may cause similar of results into wash due.

### SUBSTRATE HANDLING AFTER COMPONENT MOUNTING

(1) When substrate is divided, a flexible so that show in following diagram to substrate, and is given by stress including twist, as there is possibility that crack occurs of NTC thermistor, please check that stress is within acceptable limits.

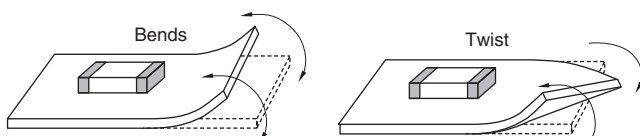

(2) During each substrate operational check, push pressure with contact failure of check pin of boards checkers of check pin may be toned up to be prevented. As substrate is bent under loading, NTC thermistor is broken owing to stress. There is also the possibility that solder on the terminal electrode will peel off. Follow the diagram for reference, and check that the substrate bends, please.

Item	Cases to avoid	Recommended case
Substrate sags	Peeling Check pin	Support pin Check pin

### SINGLE-PART COMPONENT HANDLING

(1) To drop impact, as there is possibility that breakage and crack is entered, do not NTC thermistor that (1) NTC thermistor falls.

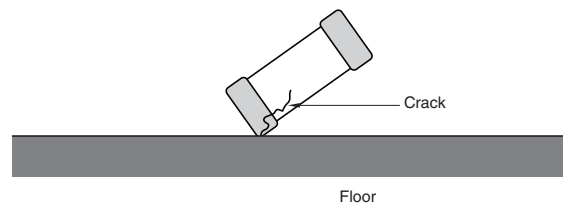

(2) At stacking storage after implementation and treatment of substrate, corner of boards is regarded as NTC thermistor. Please be careful, as there is the possibility that breakage and cracks will occur on impact.

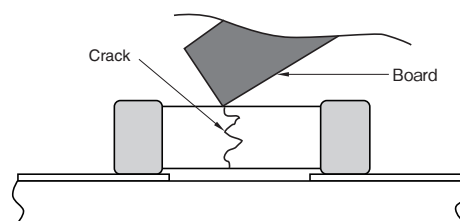



# NTC Thermistors

Automotive grade: Corresponding to 125,150,175°C

Product compatible with RoHS directive  
Compatible with lead-free solders  
AEC-Q200

## Packaging style

### REEL DIMENSIONS

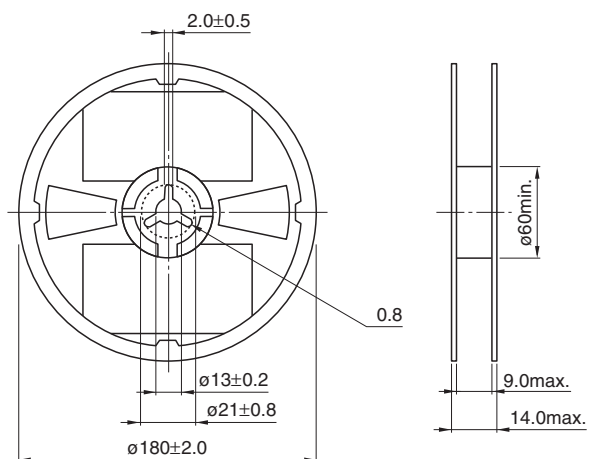

Dimensions in mm

### PACKAGE QUANTITY, PRODUCT WEIGHT

Type	Package quantity (pieces/reel)	Individual weight (mg)
NTCG06	15,000	0.3
NTCG10	10,000	1.3
NTCG16	4,000	5.0
NTCG20	2,000	7.2

### TAPE DIMENSIONS

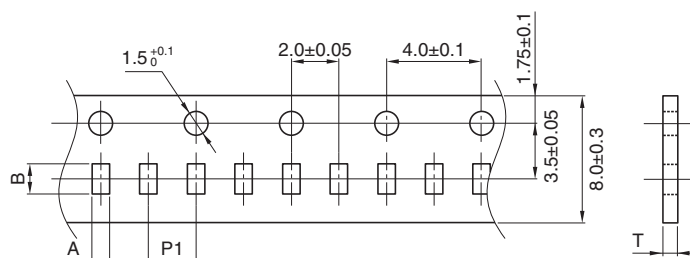

Dimensions in mm

Type	A	B	P1	T
0603	0.38±0.05	0.68±0.05	2±0.05	0.45max.
1005	0.65+0.05/-0.1	1.15+0.05/-0.1	2±0.05	0.65max.
1608	1.1±0.2	1.9±0.2	4.0±0.1	1.1max.
2012	1.6±0.2	2.3±0.2	4.0±0.1	1.1max.

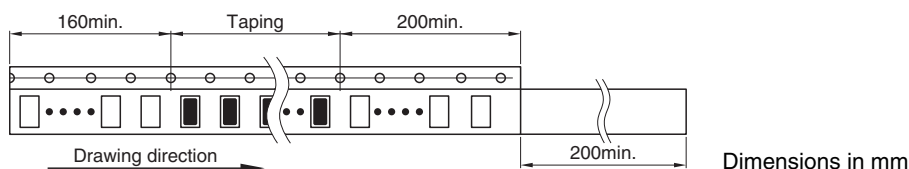

Dimensions in mm

Please be sure to request delivery specifications that provide further details on the features and specifications of the products for proper and safe use.  
Please note that the contents may change without any prior notice due to reasons such as upgrading.

# NTC Thermistors

Automotive grade:Corresponding to 125,150,175°C

Product compatible with RoHS directive  
Compatible with lead-free solders  
AEC-Q200

## Description and definition of terms

### INITIAL RESISTANCE

Thermistor resistance is a function of absolute temperature as indicated by the following relationship:

$$R=R_0 \cdot \exp B \left( \frac{1}{T} - \frac{1}{T_0} \right) \dots\dots\dots (1)$$

Here R<sub>0</sub>, R(kΩ) are the respective resistance values when the surrounding temperature is T<sub>0</sub>, T(K). B is the thermistor constant(B constant below).

### B CONSTANT

The B constant is found from the following equation:

$$B= \frac{2.3026(\log R - \log R_0)}{\frac{1}{T} - \frac{1}{T_0}} \dots\dots\dots (2)$$

This B characteristic is indicated by the slope of the linear plot of log R-1/T inverse absolute temperature. The B constant value is generally in the vicinity of 2500K to 5000K. B constant values of 3000K to 4000K are frequently used for measurements.

Resistance-temperature characteristics (Fig.1)

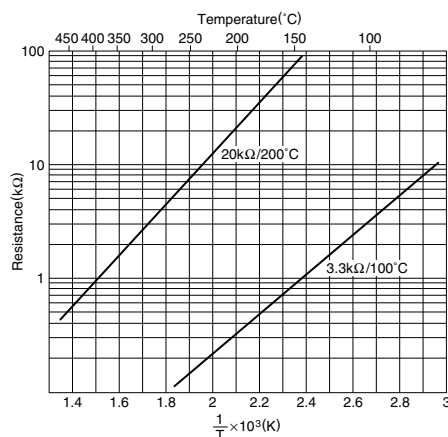

### TEMPERATURE COEFFICIENT

The relationship between temperature coefficient α and B becomes:

$$\alpha = \frac{1}{R} \cdot \frac{dR}{dT} = - \frac{B}{T^2} \times 100(\%/^{\circ}C) \dots\dots\dots (3)$$

The negative sign of the temperature coefficient indicates that the temperature coefficient decreases as both thermistor resistance and temperature rise. If B is taken as 3400K, the temperature coefficient found at 20°C (293.15K) becomes -4%/°C.

⚠ Please be sure to request delivery specifications that provide further details on the features and specifications of the products for proper and safe use. Please note that the contents may change without any prior notice due to reasons such as upgrading.