

承 认 书

SPECIFICATIONS FOR APPROVAL

客户名称:
Customer: _____

产品名称: 石英晶体谐振器
Description: _____
CRYSTAL RESONATOR

产品型号: 3225 32M 12PF 10PPM
SPECIES _____

标称频率: 32.000MHz
FREQUENC _____

料 号:
MATERIAL CODE _____
S322532M12PF10PPM

供应商确认				客户确认			
品管部 QC Dept	工程部 Engineer Dept	业务部 Trade Dept	<input checked="" type="checkbox"/> 合格 PASS	品管部 QC Dept	工程部 Engineer Dept	采购部 Purchase Dept	<input type="checkbox"/> 合格 PASS
莫 平 会	梁 雄	陈 晓 群	<input type="checkbox"/> 不合格 NG				<input type="checkbox"/> 不合格 NG

公司地址: 四川省泸州市泸县工业园 B 区明星路 204 号 (坤羽) 五、六栋
电话: 0830-8172777、0830-8106299 传真: 0830-8106266

GENERAL SPECIFICATIONS (电气特性) :

No.	Parameters	Symb.	Electrical Specification				Notes
			Min.	Typ.	Max.	Units	
1	Nominal Frequency	F0	32.000000			MHz	
2	Overtone order		Fundamental				
3	Frequency Tolerance	$\Delta F/F0$	-10	-	+10	ppm	at 25°C±3°C
4	Operating Temperature Range	T _{OPR}	-20	-	+85	°C	
5	Frequency Stability	TC	-30	-	+30	ppm	The reference temperature shall be +25°C
6	Storage Temperature	T _{STG}	-55	-	+125	°C	
7	Load capacitance	CL	-	12	-	pF	
8	Equivalent resistance	ESR	-	-	40	Ω	
9	Level of drive	DL	-	100	300	μW	
10	Insulation Resistance		500	-	-	MΩ	DC100V ±15V.
11	Shunt Capacitance	C0	-	-	7	pF	
12	Aging Per Year	Fa	-3	-	+3	ppm	First Year
13	Package type		3225 seam				

DIMENSIONS SPECIFICATIONS (外形尺寸)



Pin	Connection
#1,#3	X'tal
#2,#4	GND

Top View



Recommended Solder Pattern

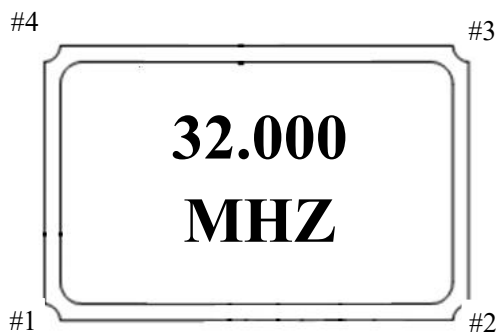
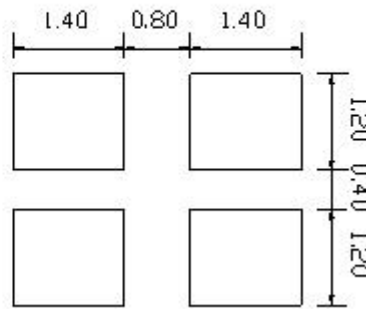

Tape Dimensions(unit : mm)



A	B	C	D	E	F
1.50	4.0	4.0	3.5	8.0	1.0

Reel Dimensions(unit: mm)



G	H	I	J	K	L	M
2.5	13.5	21.6	60.0	178	9.5	1.6

*3000pcs/Reel

No.	Test Item	Test Conditions	Spec Code
1	High Temperature Storage	Temperature: 125°C ± 5°C Time: 1000 ± 12 Hours	A
2	Temperature Cycle	Temperature 1: -55°C ± 5°C Temperature 2: 125°C ± 5°C Temperature change between T1 and T2 at soonest Run 1000 cycles, maintain T1 and T2 30 minutes each in one cycle	A
3	High Temperature, High Humidity Storage	Temperature: 85°C ± 5°C Relative Humidity: 80%--85% Time: 250Hours ± 24 Hours	A
4	Steam Aging	Temperature: 97°C ± 5°C; Time: 24 Hours 260°C solder pot to check solderability	A
5	Solderability	Pre-heat temperature: +150±10°C Pre-heat time:60~120s When the temperature of the specimen is reached at+215±3°C, it shall be left for 30±1sec. Peak temperature 240±5°C Material: Pb-free (Sn-3.0Ag-0.5Cu) Flux: Rosin resin methyl alcohol solvent (1: 4)	B
6	Aging	Temperature: 85°C ± 5°C; Time: 250 ± 12Hours	A
7	Drop Test	Preparation: Test pieces should be fixed on the dummy load with 200g weight. Condition: Height 1.5m onto concrete Drop times :10 times in 6 mutually perpendicular axes	A
8	Vibration	Frequency Range: 10Hz~2000Hz Amplitude: 1.5mm or 20G 4Hours in each direction, total 12Hours	A
9	Reflow resistance	Pre-heat temperature : +150~180°C Pre-heat time: 90±30s Heat temperature : more than +230°C Heat time: 30s ±10s Peak temperature : +260±5°C Peak time: less than 10s	A

Specification code	Specification
A	$\Delta f/f \leq \pm 3$ ppm $\Delta CI/CI \leq \pm 15\%$ or 5 Ω make use larger value
B	The electrodes should be covered by a new solder at least 90% of immersed area.