

CD4071

Quad 2-input Or Gate

Product Specification

Specification Revision History:

Version	Date	Description
2019-05-A1	2019-05	New
2021-12-A2	2021-12	Modify Ordering Information
2022-03-A3	2022-03	Modify ambient temperature to -40°C~+105°C and add electrical characteristics of -40°C~+105°C

1、 General Description

The CD4071 is a quad 2-input OR gate. The outputs are fully buffered for highest noise immunity and pattern insensitivity to output impedance variations.

It operates over a recommended V_{DD} power supply range of 3V to 15V referenced to V_{SS} (usually ground). Unused inputs must be connected to V_{DD} , V_{SS} , or another input.

Features:

- Wide supply voltage range from 3V to 15V
- Fully static operation
- 5V, 10V, and 15V parametric ratings
- Standardized symmetrical output characteristics
- Inputs and outputs are protected against electrostatic effects
- Specified from -40°C to +105°C
- Packaging information: DIP14/SOP14/TSSOP14

Ordering Information:

Tube packing specifications:

Part number	Packaging form	Marking code	Tube quantity	Boxed tube quantity	Boxed quantity	Notes
CD4071DA14.TB	DIP14	CD4071	25 PCS/tube	40 tube/box	1000 PCS/box	Dimensions of plastic enclosure: 19.0mm×6.4mm Pin spacing: 2.54mm
CD4071SA14.TB	SOP14	CD4071	50 PCS/tube	200 tube/box	10000 PCS/box	Dimensions of plastic enclosure: 8.7mm×3.9mm Pin spacing: 1.27mm
CD4071TA14.TB	TSSOP14	CD4071	94 PCS/tube	200 tube/box	18800 PCS/box	Dimensions of plastic enclosure: 5.0mm×4.4mm Pin spacing: 0.65mm

Reel packing specifications:

Part number	Packaging form	Marking code	Reel quantity	Boxed reel quantity	Notes
CD4071SA14.TR	SOP14	CD4071	4000 PCS/reel	8000 PCS/box	Dimensions of plastic enclosure: 8.7mm×3.9mm Pin spacing: 1.27mm
CD4071TA14.TR	TSSOP14	CD4071	5000 PCS/reel	10000 PCS/box	Dimensions of plastic enclosure: 5.0mm×4.4mm Pin spacing: 0.65mm

Note: If the physical information is inconsistent with the ordering information, please refer to the actual product.



2、Block Diagram And Pin Description

2.1、Block Diagram

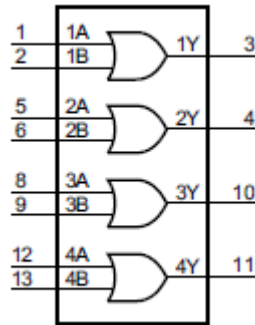

Figure 1. Functional diagram

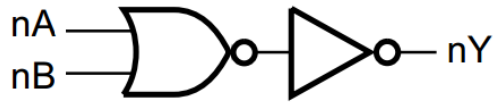
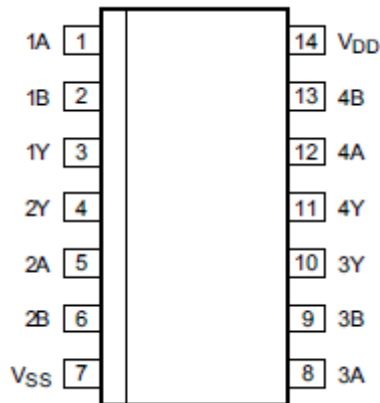

Figure 2. Logic diagram (one gate)

2.2、Pin Configurations





2.3、Pin Description

Pin No.	Pin Name	Description
1	1A	data input
2	1B	data input
3	1Y	data output
4	2Y	data output
5	2A	data input
6	2B	data input
7	V _{SS}	ground (0V)
8	3A	data input
9	3B	data input
10	3Y	data output
11	4Y	data output
12	4A	data input
13	4B	data input
14	V _{DD}	supply voltage

2.4、Function Table

Input		Output
nA	nB	nY
L	L	L
L	H	H
H	L	H
H	H	H

Note: H=HIGH voltage level; L=LOW voltage level.

3、Electrical Parameter

3.1、Absolute Maximum Ratings

(Voltages are referenced to V_{SS} (ground=0V), unless otherwise specified.)

Parameter	Symbol	Conditions	Min.	Max.	Unit
supply voltage	V _{DD}	-	-0.5	+18	V
DC input current	I _{IK}	any one input	-	±10	mA
input voltage	V _I	all inputs	-0.5	V _{DD} +0.5	V
storage temperature	T _{stg}	-	-65	+150	°C
total power dissipation	P _{tot}	-	-	500	mW
device dissipation	P	per output transistor	-	100	mW
Soldering temperature	T _L	10s	DIP	245	°C
			SOP	250	°C

Note:

[1] For DIP14 packages: above 70°C the value of P_{tot} derates linearly with 12mW/K.

[2] For SOP14 packages: above 70°C the value of P_{tot} derates linearly with 8mW/K.

[3] For (T)SSOP14 packages: above 60°C the value of P_{tot} derates linearly with 5.5mW/K.



3.2、Recommended Operating Conditions

Parameter	Symbol	Conditions	Min.	Typ.	Max.	Unit
supply voltage	V_{DD}	-	3	-	15	V
ambient temperature	T_{amb}	in free air	-40	-	+105	°C

3.3、Electrical Characteristics

3.3.1、DC Characteristics 1

($T_{amb}=25^{\circ}\text{C}$, voltages are referenced to V_{SS} (ground=0V), unless otherwise specified.)

Parameter	Symbol	Conditions (V)			$T_{amb}=25^{\circ}\text{C}$			Unit
		V_O	V_{IN}	V_{DD}	Min.	Typ.	Max.	
supply current	I_{DD}	-	0, 5	5	-	0.01	0.25	uA
		-	0, 10	10	-	0.01	0.5	uA
		-	0, 15	15	-	0.01	1	uA
LOW-level output current	I_{OL}	0.4	0, 5	5	0.51	1	-	mA
		0.5	0, 10	10	1.3	2.6	-	mA
		1.5	0, 15	15	3.4	6.8	-	mA
HIGH-level output current	I_{OH}	4.6	0, 5	5	-0.51	-1	-	mA
		2.5	0, 5	5	-1.6	-3.2	-	mA
		9.5	0, 10	10	-1.3	-2.6	-	mA
		13.5	0, 15	15	-3.4	-6.8	-	mA
LOW-level output voltage	V_{OL}	-	0, 5	5	-	0	0.05	V
		-	0, 10	10	-	0	0.05	V
		-	0, 15	15	-	0	0.05	V
HIGH-level output voltage	V_{OH}	-	0, 5	5	4.95	5	-	V
		-	0, 10	10	9.95	10	-	V
		-	0, 15	15	14.95	15	-	V
LOW-level input voltage	V_{IL}	0.5, 4.5	-	5	-	-	1.5	V
		1, 9	-	10	-	-	3	V
		1.5, 13.5	-	15	-	-	4	V
HIGH-level input voltage	V_{IH}	4.5	-	5	3.5	-	-	V
		9	-	10	7	-	-	V
		13.5	-	15	11	-	-	V
input leakage current	I_I	-	0, 15	15	-	$\pm 10^{-5}$	± 0.1	uA



3.3.2、DC Characteristics 2

($T_{amb}=-40^{\circ}\text{C}$ to $+105^{\circ}\text{C}$, voltages are referenced to V_{SS} (ground=0V), unless otherwise specified.)

Parameter	Symbol	Conditions (V)			$T_{amb}=-40^{\circ}\text{C}$		$T_{amb}=+85^{\circ}\text{C}$		$T_{amb}=+105^{\circ}\text{C}$		Unit
		V_O	V_{IN}	V_{DD}	Min.	Max.	Min.	Max.	Min.	Max.	
supply current	I_{DD}	-	0, 5	5	-	0.25	-	7.5	-	7.5	μA
		-	0, 10	10	-	0.5	-	15	-	15	μA
		-	0, 15	15	-	1	-	30	-	30	μA
LOW-level output current	I_{OL}	0.4	0, 5	5	0.61	-	0.42	-	0.36	-	mA
		0.5	0, 10	10	1.5	-	1.1	-	0.9	-	mA
		1.5	0, 15	15	4	-	2.8	-	2.4	-	mA
HIGH-level output current	I_{OH}	4.6	0, 5	5	-0.61	-	-0.42	-	-0.36	-	mA
		2.5	0, 5	5	-1.8	-	-1.3	-	-1.15	-	mA
		9.5	0, 10	10	-1.5	-	-1.1	-	-0.9	-	mA
		13.5	0, 15	15	-4	-	-2.8	-	-2.4	-	mA
LOW-level output voltage	V_{OL}	-	0, 5	5	-	0.05	-	0.05	-	0.05	V
		-	0, 10	10	-	0.05	-	0.05	-	0.05	V
		-	0, 15	15	-	0.05	-	0.05	-	0.05	V
HIGH-level output voltage	V_{OH}	-	0, 5	5	4.95	-	4.95	-	4.95	-	V
		-	0, 10	10	9.95	-	9.95	-	9.95	-	V
		-	0, 15	15	14.95	-	14.95	-	14.95	-	V
LOW-level input voltage	V_{IL}	0.5, 4.5	-	5	-	1.5	-	1.5	-	1.5	V
		1, 9	-	10	-	3	-	3	-	3	V
		1.5, 13.5	-	15	-	4	-	4	-	4	V
HIGH-level input voltage	V_{IH}	4.5	-	5	3.5	-	3.5	-	3.5	-	V
		9	-	10	7	-	7	-	7	-	V
		13.5	-	15	11	-	11	-	11	-	V
input leakage current	I_I	-	0, 15	15	-	± 0.1	-	± 1	-	± 1	μA

3.3.3、AC Characteristics

($T_{amb}=25^{\circ}\text{C}$, $V_{SS}=0\text{V}$, $t_r, t_f=20\text{ns}$, $C_L=50\text{pF}$, $R_L=200\text{k}\Omega$, unless otherwise specified.)

Parameter	Symbol	Conditions	Min.	Typ.	Max.	Unit	
propagation delay time	t_{PHL}, t_{PLH}	see Figure 4	$V_{DD}=5\text{V}$	-	125	250	ns
			$V_{DD}=10\text{V}$	-	60	120	ns
			$V_{DD}=15\text{V}$	-	45	90	ns
transition time	t_{THL}, t_{TLH}	see Figure 4	$V_{DD}=5\text{V}$	-	100	200	ns
			$V_{DD}=10\text{V}$	-	50	100	ns
			$V_{DD}=15\text{V}$	-	40	80	ns
input capacitance	C_I	any input	-	5	7.5	pF	



4、Testing Circuit

4.1、AC Testing Circuit

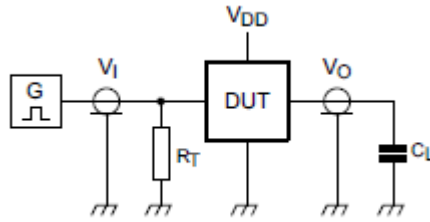

Figure 3. Test circuit for switching times

Definitions for test circuit:

DUT=Device Under Test.

C_L =Load capacitance including jig and probe capacitance.

R_T =Termination resistance should be equal to the output impedance Z_o of the pulse generator.

4.2、AC Testing Waveforms

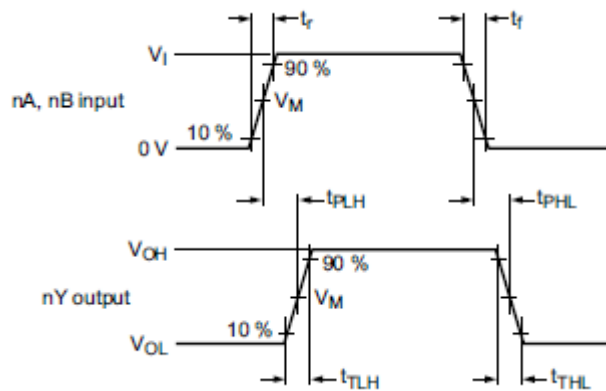

Figure 4. Propagation delay, output transition time

4.3、Measurement Points

Supply voltage	Input	Output
V_{DD}	V_M	V_M
5V to 15V	$0.5 \times V_{DD}$	$0.5 \times V_{DD}$

4.4、Test Data

Supply voltage	Input		Load
V_{DD}	V_I	t_r, t_f	C_L
5V to 15V	V_{SS} or V_{DD}	$\leq 20ns$	50pF



5、Package Information

5.1、DIP14

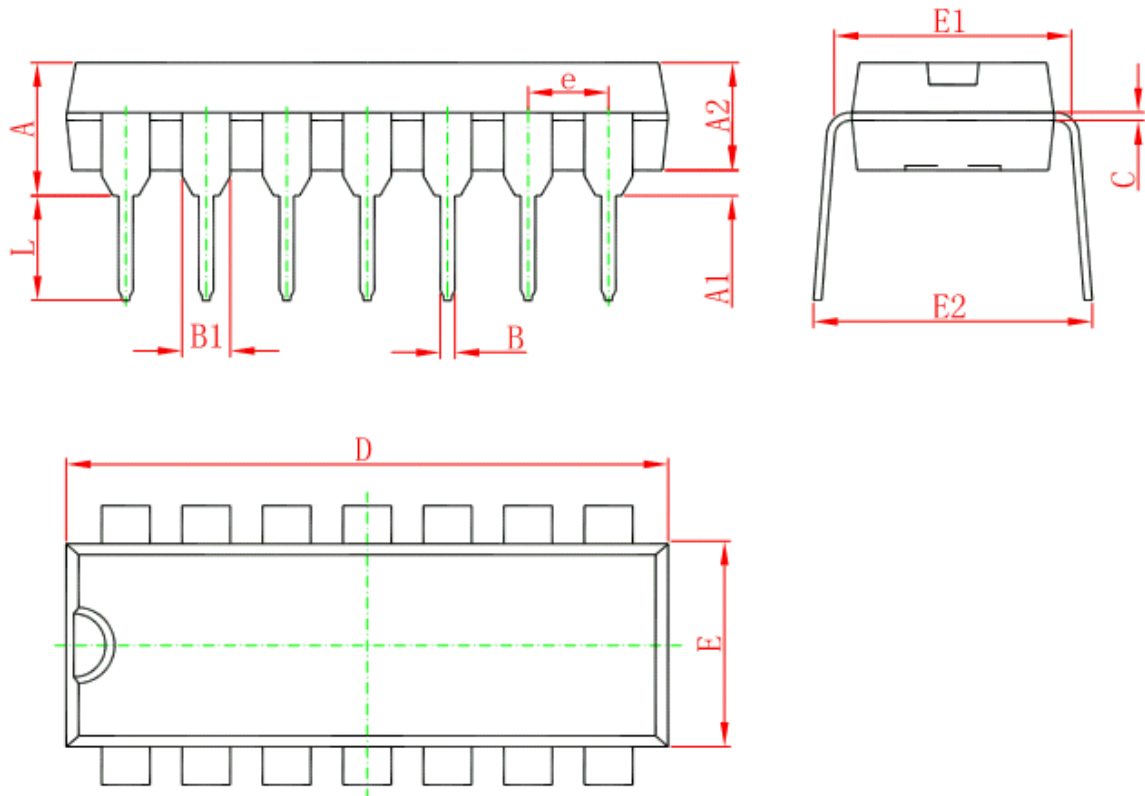

Symbol	Dimensions In Millimeters		Dimensions In Inches	
	Min	Max	Min	Max
A	3.710	4.310	0.146	0.170
A1	0.510		0.020	
A2	3.200	3.600	0.126	0.142
B	0.380	0.570	0.015	0.022
B1	1.524 (BSC)		0.060 (BSC)	
C	0.204	0.360	0.008	0.014
D	18.800	19.200	0.740	0.756
E	6.200	6.600	0.244	0.260
E1	7.320	7.920	0.288	0.312
e	2.540 (BSC)		0.100 (BSC)	
L	3.000	3.600	0.118	0.142
E2	8.400	9.000	0.331	0.354



5.2、SOP14

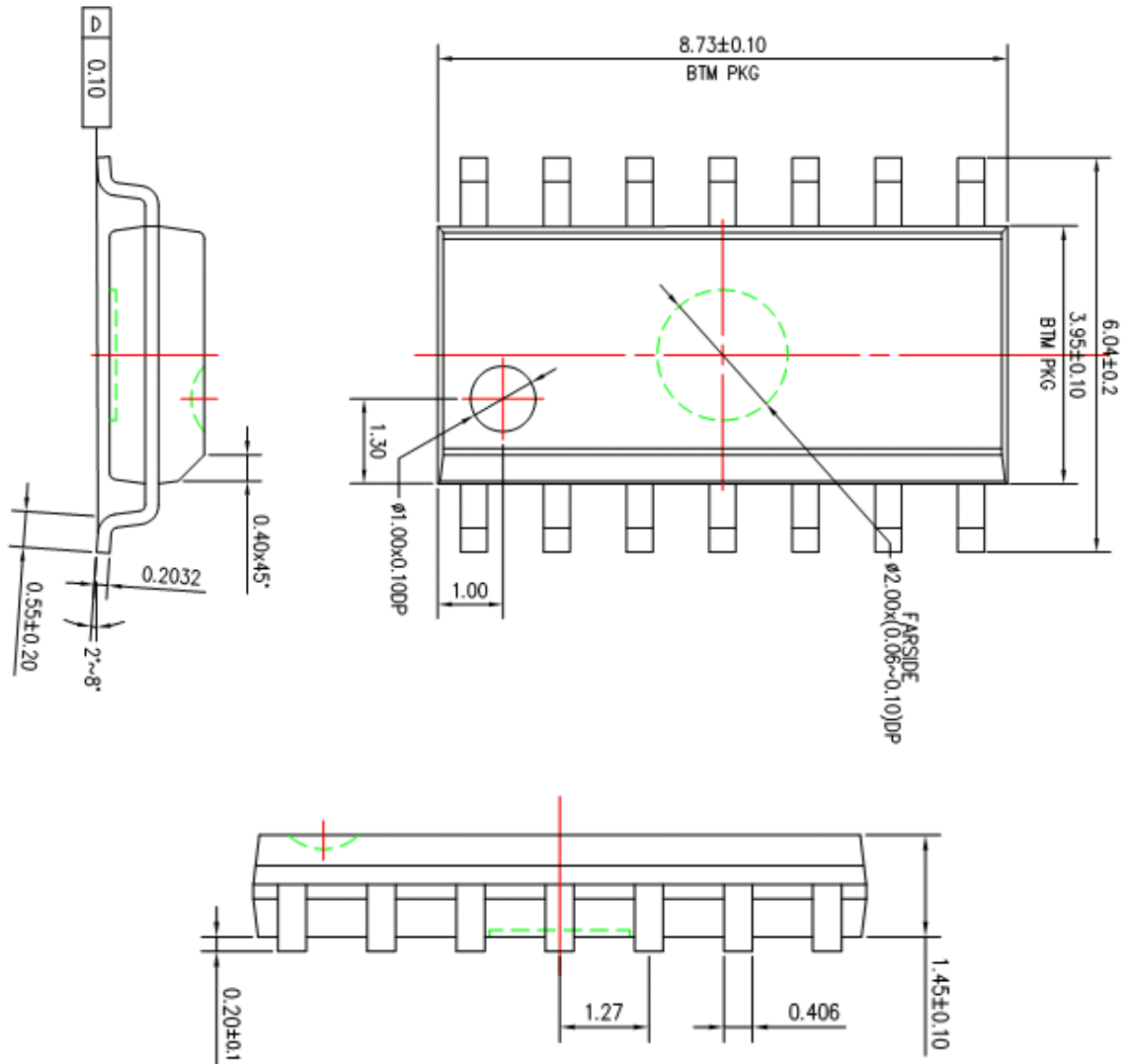



5.3、TSSOP14

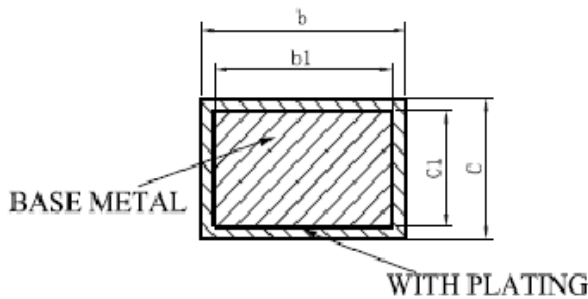
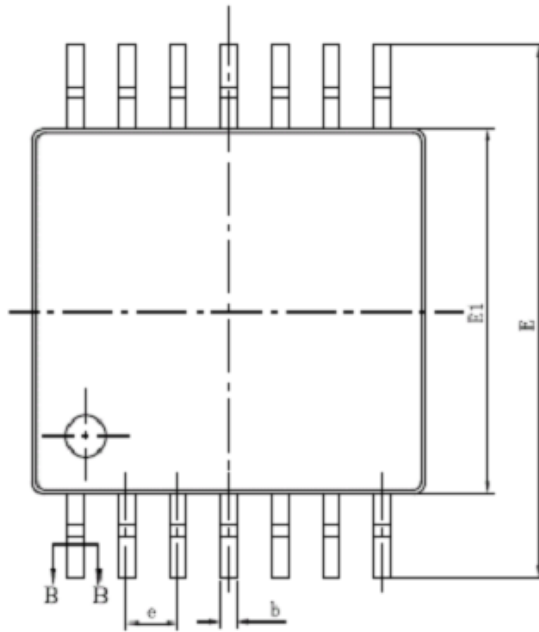
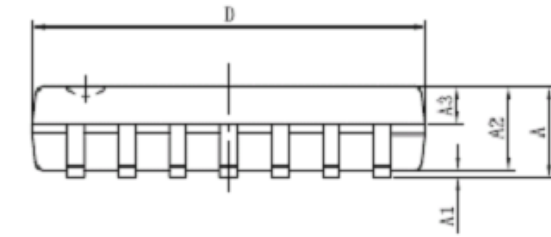

SECTION B-B

SYMBOL	MILLIMETER	
	MIN	MAX
A	—	1.20
A1	0.05	0.15
A2	0.90	1.05
A3	0.39	0.49
b	0.20	0.30
b1	0.19	0.25
c	0.13	0.19
c1	0.12	0.14
D	4.86	5.06
E1	4.30	4.50
E	6.20	6.60
e	0.65BSC	
L	0.45	0.75
L1	1.00BSC	
θ	0	8°



6、 Statements And Notes

6.1、 The name and content of Hazardous substances or Elements in the product

Part name	Hazardous substances or Elements									
	Lead and lead compounds	Mercury and mercury compounds	Cadmium and cadmium compounds	Hexavalent chromium compounds	Polybrominated biphenyls	Polybrominated biphenyl ethers	Dibutyl phthalate	Butylbenzyl phthalate	Di-2-ethylhexyl phthalate	Diisobutyl phthalate
Lead frame	○	○	○	○	○	○	○	○	○	○
Plastic resin	○	○	○	○	○	○	○	○	○	○
Chip	○	○	○	○	○	○	○	○	○	○
The lead	○	○	○	○	○	○	○	○	○	○
Plastic sheet installed	○	○	○	○	○	○	○	○	○	○
explanation	○: Indicates that the content of hazardous substances or elements in the detection limit of the following the SJ/T11363-2006 standard. ×: Indicates that the content of hazardous substances or elements exceeding the SJ/T11363-2006 Standard limit requirements.									

6.2、 Notion

Recommended carefully reading this information before the use of this product;

The information in this document are subject to change without notice;

This information is using to the reference only, the company is not responsible for any loss;

The company is not responsible for the any infringement of the third party patents or other rights of the responsibility.