

SCHOTTKY DIODES

Features

- ◆ Fast switching speed
- ◆ Guard ring construction for transient protection
- ◆ Negligible reverse recovery time
- ◆ low reverse capacitance

SOD-123

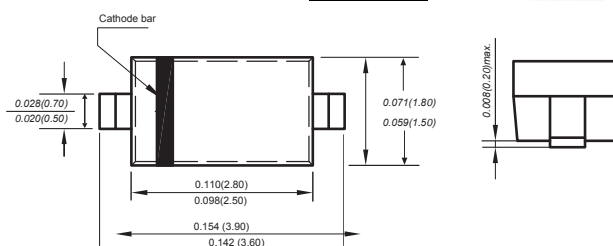

Mechanical Data

Case: JEDEC SOD-123 molded plastic body
 Terminals: Plated leads solderable per MIL-STD-750, Method 2026

Polarity: Polarity symbols marked on case

Weight : 0.0007 ounce, 0.02 grams

Marking: SD103AW:S4, SD103BW:S5, SD103CW:S6

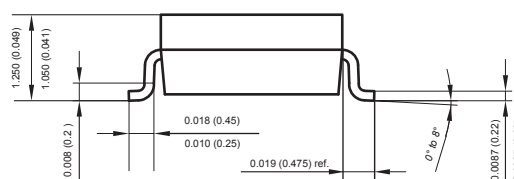

Dimensions in inches and (millimeters)

Absolute Maximum Ratings at 25 °C

PARAMETER	SYMBOLS	SD103AW	SD103BW	SD103CW	UNITS
Peak repetitive peak reverse voltage	V_{RRM}				VOLTS
Working peak reverse voltage	V_{RWM}	40	30	20	
DC Blocking voltage	V_{DC}				
RMS Reverse voltage	$V_{R(RMS)}$	28	21	14	V
Forward continuous current	I_{FM}	350			mA
Repetitive peak forward current at $\leq 1.0s$	I_{FRM}	1.5			A
Power dissipation	P_d	400			mW
Thermal resistance junction to ambient	$R_{\theta JA}$	300			$^{\circ}C/W$
Storage temperature	T_{STG}	-55 to +150			$^{\circ}C$

Characteristics at $T_a = 25^{\circ}C$

PARAMETER	SYMBOLS	Min.	Typ.	Max.	Unit	Conditions
Reverse breakdown voltage	$V_{(BR)R}$	40			V	$I_R = 100\mu A$
Reverse voltage		30				$I_R = 100\mu A$
Reverse		20				$I_R = 100\mu A$
Forward voltage	V_F			0.37 0.60	V	$I_F = 20mA$ $I_F = 200mA$
Reverse current	I_{RM}			5.0	μA	$V_R = 30V$
						$V_R = 20V$
						$V_R = 10V$
Capacitance between terminals	C_T		28		pF	$V_R = 0V, f = 1.0MHz$
Reverse recovery time	t_{rr}		10		ns	$I_F = I_R = 200mA$ $I_{rr} = 0.1 \times I_R, R_L = 100 \Omega$

Typical Characteristics

Forward Characteristics

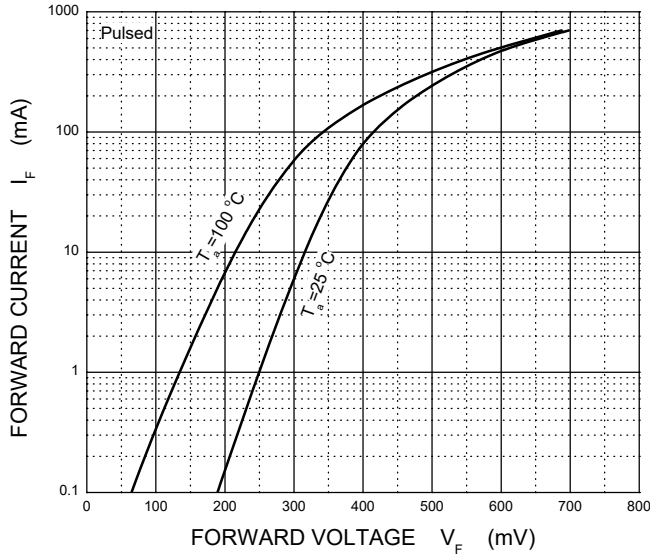

Reverse Characteristics

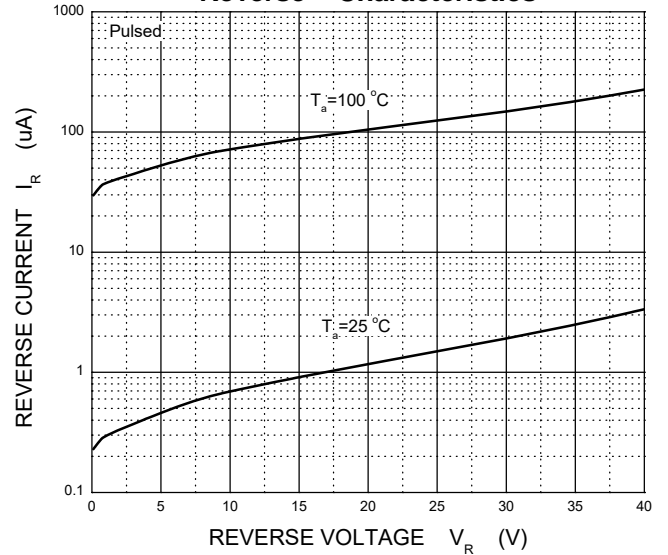

Capacitance Characteristics

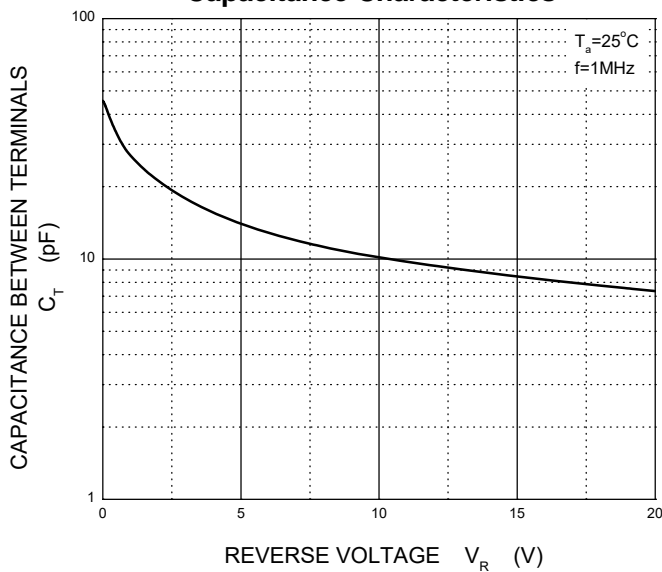

Power Derating Curve

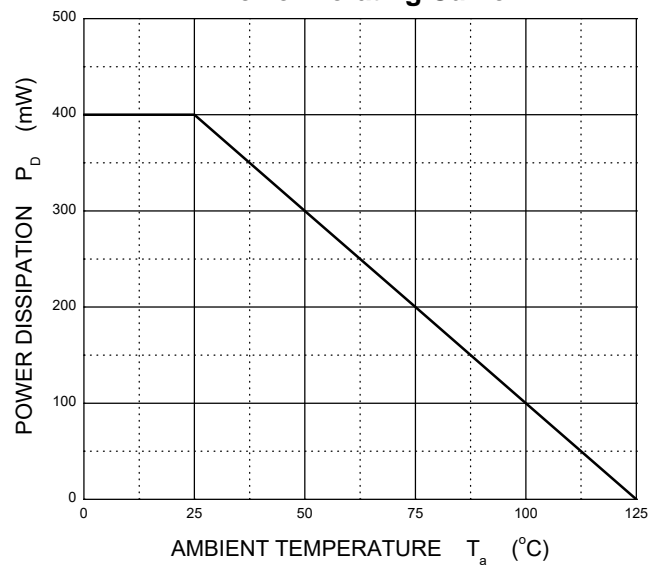

The curve above is for reference only.

Packing information

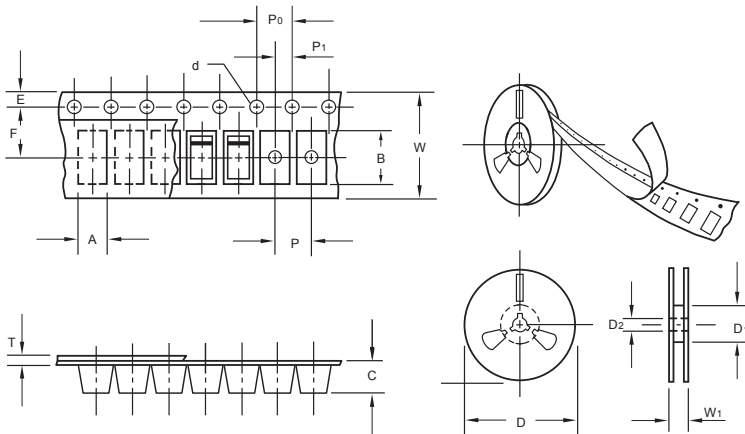

unit:mm

Item	Symbol	Tolerance	SOD-123
Carrier width	A	0.1	2.1
Carrier length	B	0.1	4.0
Carrier depth	C	0.1	1.60
Sprocket hole	d	0.05	1.55
7" Reel outside diameter	D	2.0	178.00
7" Reel inner diameter	D ₁	min	50.0
Feed hole diameter	D ₂	0.5	13.00
Sprocket hole position	E	0.1	1.75
Punch hole position	F	0.1	3.50
Punch hole pitch	P	0.1	4.00
Sprocket hole pitch	P ₀	0.1	4.00
Embossment center	P ₁	0.1	2.00
Overall tape thickness	T	0.1	0.25
Tape width	W	0.3	8.15
Reel width	W ₁	1.0	10.5

Note: Devices are packed in accordance with EIA standard RS-481-A and specifications listed above.

Reel packing

PACKAGE	REEL SIZE	REEL (pcs)	COMPONENT SPACING (m/m)	BOX (pcs)	INNER BOX (m/m)	REEL DIA, (m/m)	CARTON SIZE (m/m)	CARTON (pcs)	APPROX. GROSS WEIGHT (kg)
SOD-123	7"	3,000	4.0	45,000	210*208*203	178	430*430*235	180,000	9.0

Suggested Pad Layout

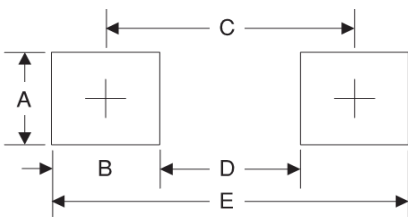

Symbol	Unit (mm)	Unit (inch)
A	1.2	0.047
B	1.2	0.047
C	3.2	0.126
D	2.0	0.079
E	4.4	0.173