

## GLASS PASSIVATED SURFACE MOUNT BRIDGE RECTIFIERS

### Features

- ◆ Glass Passivated Chip Junction
- ◆ Reverse Voltage - 200 to 1000 V
- ◆ Forward Current- 4 A
- ◆ High Surge Current Capability
- Designed for Surface Mount Application

UMSB

ROHS  
COMPLIANT

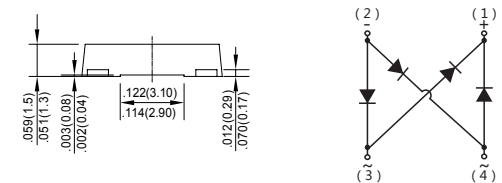
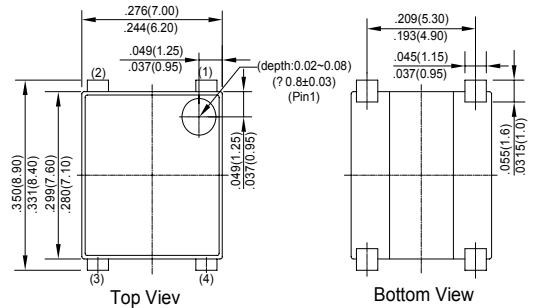

Dimensions in inches and (millimeters)

### Mechanical Data

Case: JEDEC UMSB molded plastic body  
 Terminals: Solderable per MIL-STD-750, Method 2026A  
 Polarity: Polarity symbol marking on body  
 Mounting Position: Any  
 Weight: 0.00825 ounce, 0.234 grams

### Maximum Ratings And Electrical Characteristics

Ratings at 25°C ambient temperature unless otherwise specified.

Single phase half-wave 60Hz, resistive or inductive load, for capacitive load current derate by 20%.

Parameter	Symbols	MSB40D	MSB40G	MSB40J	MSB40K	MSB40M	Units
		MDD MB40D	MDD MB40G	MDD MB40J	MDD MB40K	MDD MB40M	
Maximum Repetitive Peak Reverse Voltage	$V_{RRM}$	200	400	600	800	1000	V
Maximum RMS voltage	$V_{RMS}$	140	280	420	560	700	V
Maximum DC Blocking Voltage	$V_{DC}$	200	400	600	800	1000	V
Maximum Average Forward Rectified Current	$I_{F(AV)}$	4					A
Peak Forward Surge Current 8.3 ms Single Half Sine Wave Superimposed on Rated Load (JEDEC Method)	$I_{FSM}$	95					A
Maximum Forward Voltage at 4.0 A	$V_F$	1.1					V
Maximum DC Reverse Current @ $T_a=25^\circ\text{C}$ at Rated DC Blocking Voltage @ $T_a=125^\circ\text{C}$	$I_R$	5 100					$\mu\text{A}$
Typical Junction Capacitance per element	$C_j$	50					pF
Typical Thermal Resistance ( Note2 )	$R_{\theta JA}$ $R_{\theta JC}$ $R_{\theta JL}$	60 10 25					$^\circ\text{C/W}$
Operating and Storage Temperature Range	$T_j, T_{stg}$	-55 ~ +150					$^\circ\text{C}$

Note: 1. Measured at 1MHz and applied reverse voltage of 4 V D.C.

2. P.C.B. mounted with 4×1.5"×1.5" ( 3.81×3.81 cm ) copper pad areas.

## Typical Characteristics

**Fig.1 Average Rectified Output Current Derating Curve**

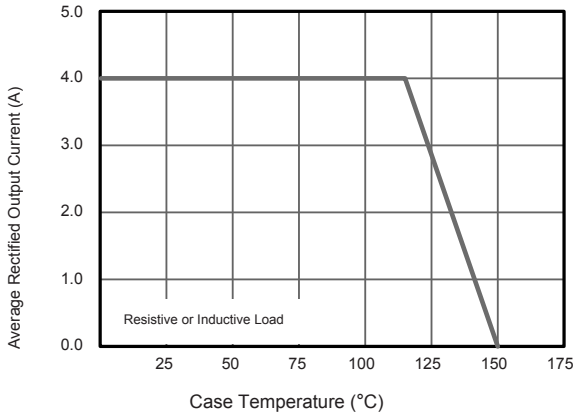

**Fig.2 Typical Reverse Characteristics**

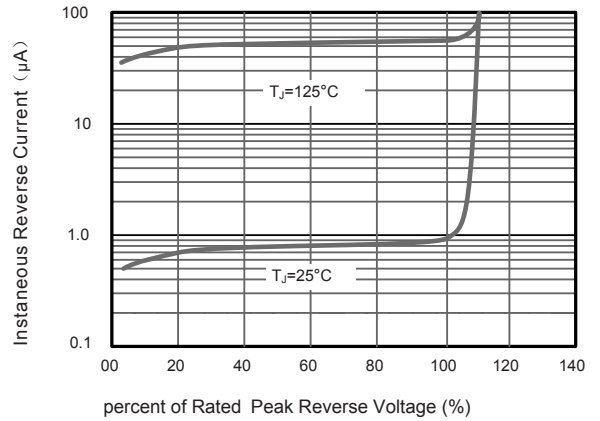

**Fig.3 Typical Instantaneous Forward Characteristics  $T_j = 25^\circ\text{C}$**

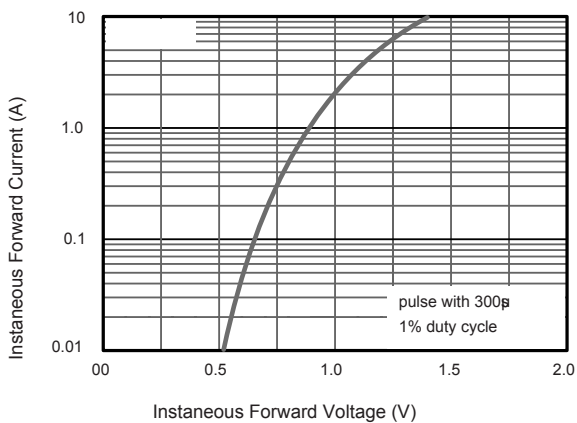

**Fig.4 Typical Junction Capacitance**

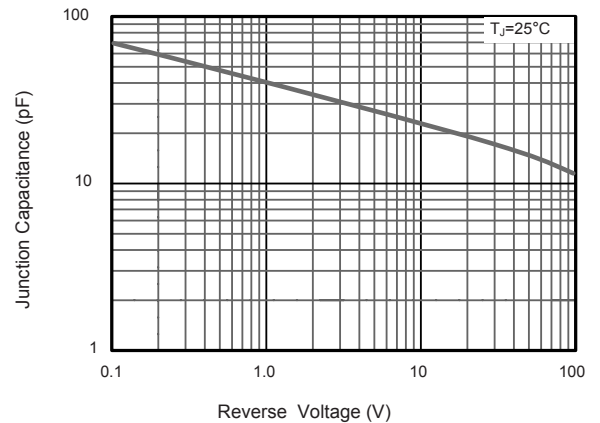

**Fig.5 Maximum Non-Repetitive Peak Forward Surge Current**

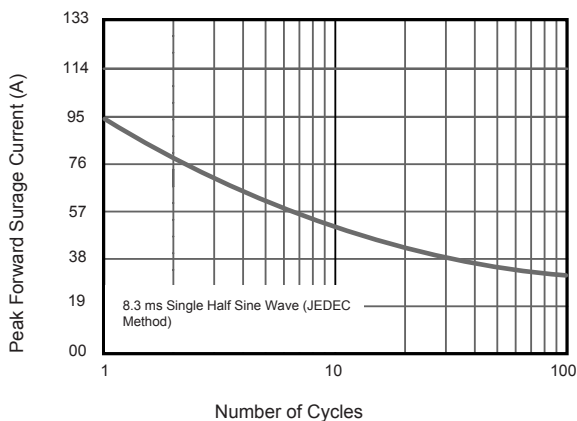

**Fig.6- Typical Transient Thermal Impedance**

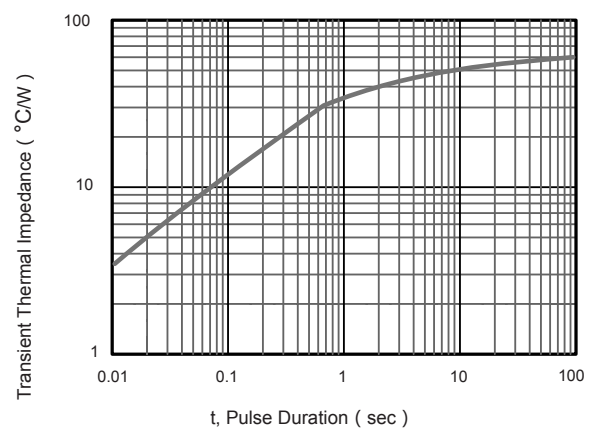

The curve above is for reference only.