

FAST SWITCHING DIODES

Features

- ◆ For surface mounted applications
- ◆ Glass Passivated Chip Junction
- ◆ Fast reverse recovery time
- ◆ Ideal for automated placement
- ◆ Lead free in comply with EU RoHS 2011/65/EU directives

Mechanical Data

Case: JEDEC SOD-323 molded plastic body
 Terminals: Plated leads solderable per MIL-STD-750, Method 2026
 Polarity: Polarity symbols marked on case
 Weight : 0.00019 ounce, 0.0548 grams
 Marking:BAV19WS:A8, BAV20WS:T2, BAV21WS:T3

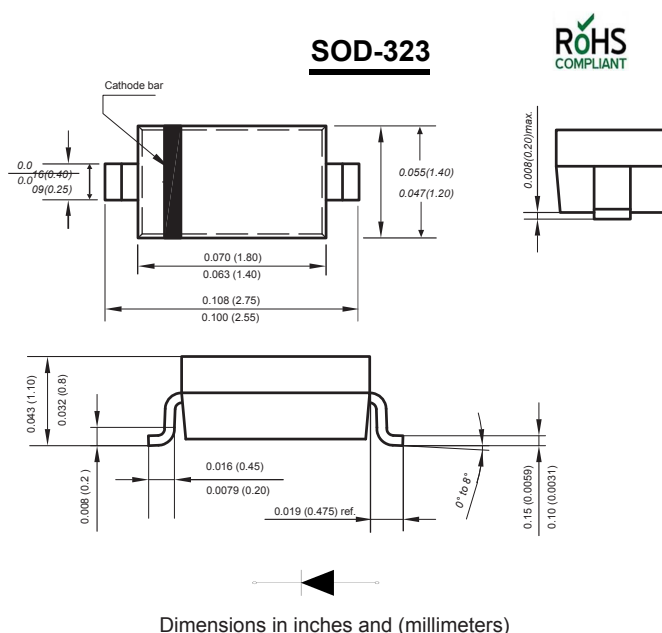

Absolute Maximum Ratings at 25 °C

PARAMETER	SYMBOLS	BAV19WS	BAV20WS	BAV21WS	UNITS
Maximum Repetitive Peak Reverse Voltage	V_{RRM}	120	200	250	V
Maximum RMS voltage	$V_{R(RMS)}$	100	150	200	V
Continuous Forward Current	I_o		250		mA
Repetitive Peak Forward Current	I_{FM}		625		mA
Non-reptitive Peak forward surge current @=1s @=1ms @=1us	I_{FSM}		1 3 9		A
Total Power dissipation	P_{tot}		500		mW
Operating junction temperature	T_j		-55 to +150		°C
Storage temperature	T_{STG}		-55 to +150		°C

Characteristics at Ta= 25 °C

Parameter	Symbol	Test conditions	Min	Typ	Max	Unit
Reverse current	I_R	$V_R=120V$ BAV19WS	$T_a = 25\text{ °C}$		0.1	uA
			$T_a = 150\text{ °C}$		100	
		$V_R=200V$ BAV20WS	$T_a = 25\text{ °C}$		0.1	uA
			$T_a = 150\text{ °C}$		100	
		$V_R=250V$ BAV21WS	$T_a = 25\text{ °C}$		0.1	uA
			$T_a = 150\text{ °C}$		100	
Forward voltage	V_F	$I_F=100mA$			1	V
		$I_F=200mA$			1.25	
Total capacitance	C_{tot}	$V_R=0V, f=1MHz$			5	pF
Reverse recovery time	t_{rr}	$I_F=0.5A, I_R=1A, I_{rr}=0.25A, R_L=100\Omega$			50	ns

Typical Characteristics

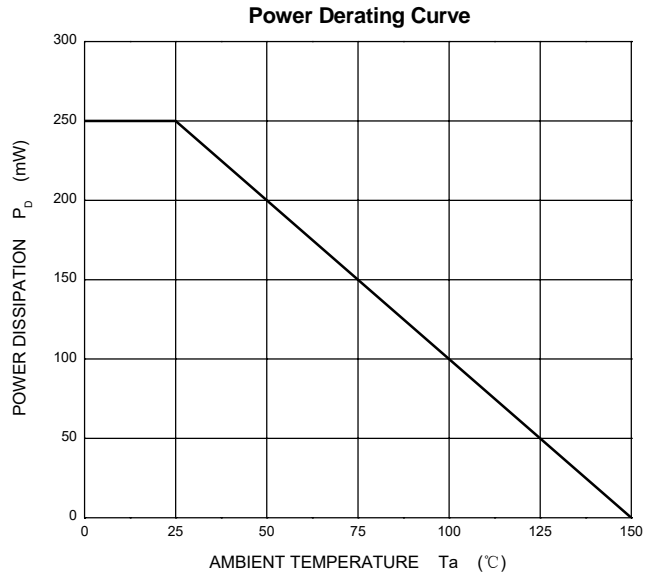
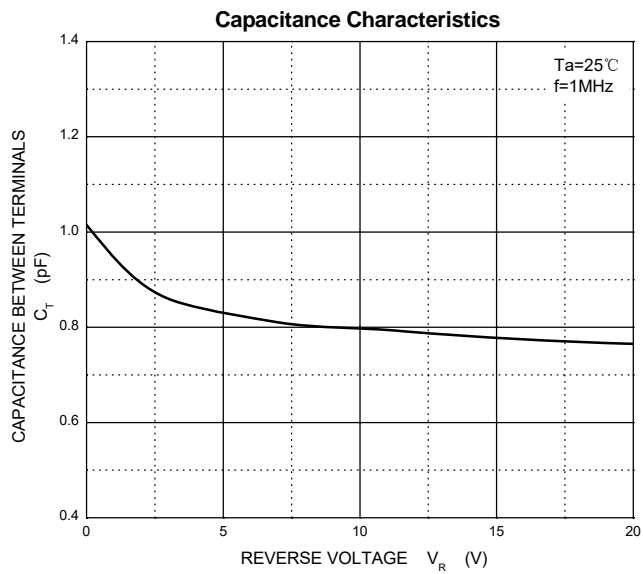
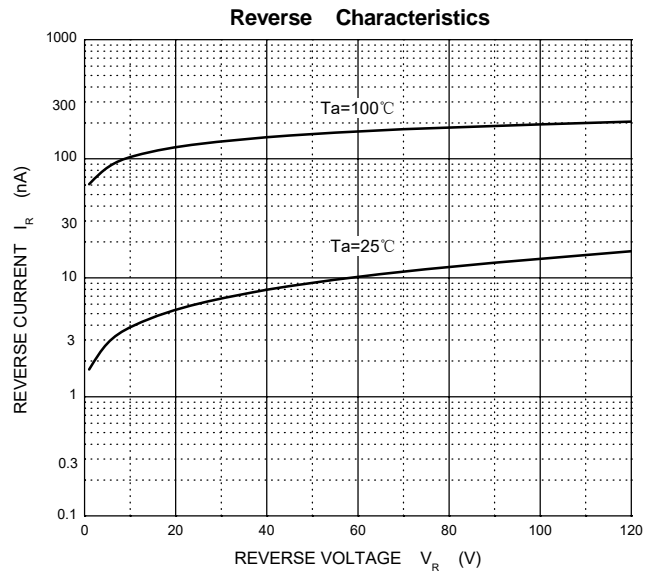
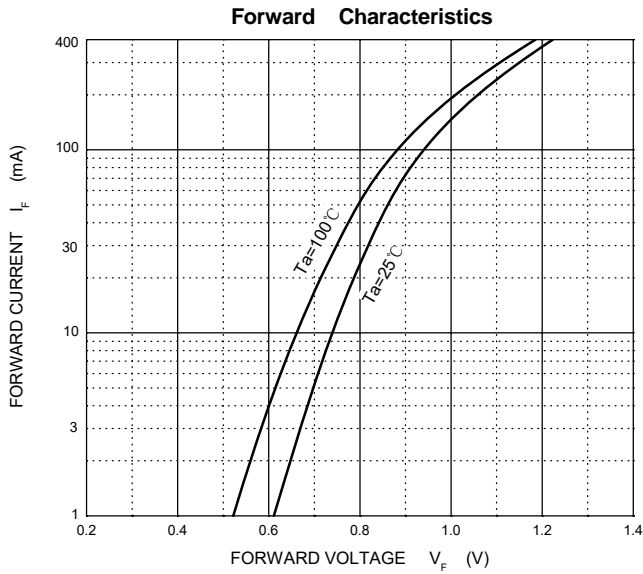

The curve above is for reference only.

Packing information

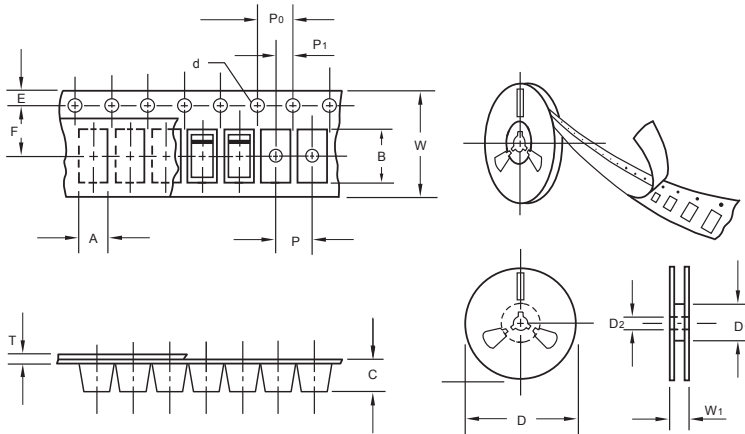

unit:mm

Item	Symbol	Tolerance	SOD-323
Carrier width	A	0.1	1.46
Carrier length	B	0.1	2.90
Carrier depth	C	0.1	1.25
Sprocket hole	d	0.05	1.50
13" Reel outside diameter	D	2.0	330.00
13" Reel inner diameter	D1	min	50.00
7" Reel outside diameter	D	2.0	178.00
7" Reel inner diameter	D1	min	54.40
Feed hole diameter	D2	0.5	13.00
Sprocket hole position	E	0.1	1.75
Punch hole position	F	0.1	3.50
Punch hole pitch	P	0.1	4.00
Sprocket hole pitch	P0	0.1	4.00
Embossment center	P1	0.1	2.00
Overall tape thickness	T	0.1	0.06
Tape width	W	0.3	8.00
Reel width	W1	1.0	12.30

Note: Devices are packed in accordance with EIA standard RS-481-A and specifications listed above.

Reel packing

PACKAGE	REEL SIZE	REEL (pcs)	COMPONENT SPACING (m/m)	BOX (pcs)	INNER BOX (m/m)	REEL DIA. (m/m)	CARTON SIZE (m/m)	CARTON (pcs)	APPROX. GROSS WEIGHT (kg)
SOD-323	7"	3,000	4.0	45,000	210*208*203	178	430*430*235	180,000	9.0

Suggested Pad Layout

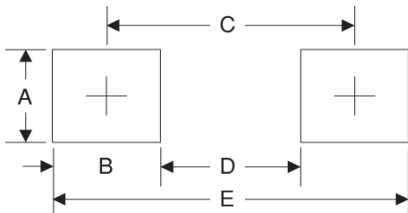

Symbol	Unit (mm)	Unit (inch)
A	1.2	0.047
B	1.2	0.047
C	3.6	0.141
D	1.4	0.055
E	3.8	0.149