

SOT-523 Plastic-Encapsulate TVS/ESD Protection Diodes

DESCRIPTION

ESD0502T5L is an ultra-low capacitance Transient Voltage Suppressor (TVS) designed to provide electrostatic discharge (ESD) protection for high-speed data interfaces. With typical capacitance of 0.2pF (I/O to I/O) only, ESD0502T5L is designed to protect parasitic-sensitive systems against over-voltage and over-current transient events. It complies with IEC 61000-4-2 (ESD), Level 4 ($\pm 15\text{kV}$ air, $\pm 8\text{kV}$ contact discharge), IEC 61000-4-4 (electrical fast transient - EFT) (40A, 5/50 ns), very fast charged device model (CDM) ESD and cable discharge event (CDE), etc.

ESD0502T5L uses small SOT-523 package. Each ESD0502T5L device can protect two high-speed data lines. The combined features of low capacitance, small size and high ESD robustness make ESD0502T5L ideal for high-speed data port and high-frequency line applications. The low clamping voltage of the ESD0502T5L guarantees a minimum stress on the protected IC.

Features

- ◆ Peak Power Dissipation : 60W (8/20 μs)
- ◆ Transient protection for high speed data lines
- ◆ IEC61000-4-2 (ESD) $\pm 15\text{kV}$ (air), $\pm 8\text{kV}$ (contact)
- ◆ IEC61000-4-4 (EFT) 40A (5/50ns)
Cable Discharge Event (CDE)
- ◆ Small package (1.6mm \times 0.8mm \times 0.75mm)
- ◆ Protect two data lines
- ◆ Low clamping voltage
- ◆ Low Capacitance : 0.2pF Typical (I/O - I/O)
- ◆ Low leakage current
- ◆ Meets MSL 1 Requirementst

Pin Configuration

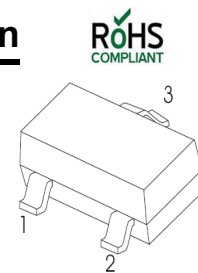

RoHS
COMPLIANT

Circuit Diagram

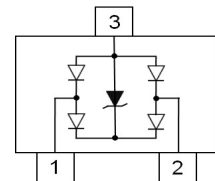

Applications

- ◆ Serial ATA
- ◆ Desktops, Servers and Notebooks
- ◆ PCI Express
- ◆ MDDI Ports
- ◆ USB Data Line Protection
- ◆ HDMI Ports
- ◆ Digital Visual Interfacsess (DVI)

Mechanical Characteristics

- ◆ Package: SOT-523
- ◆ Flammability Rating: UL 94V-0
- ◆ Terminal: Matte tin plated.
- ◆ High temperature soldering guaranteed:
260 C/10s
- ◆ Marking: 52L
- ◆ Packaging: Tape and Reel

Absolute Maximum Ratings (T_A=25°C unless otherwise specified)

Parameter	Symbol	Value	Unit
Peak Pulse Power(8/20us)	P _{PP}	60	W
ESD per IEC 61000-4-2 (Air)	V _{ESD}	± 20	KV
ESD per IEC 61000-4-2 (Contact)		± 20	
Operating Temperature	T _{OPT}	-55 to +125	°C
Storage Temperature	T _{STG}	-55 to +125	°C
Lead Solder Temperature – Maximum (10 Second Duration)	T _L	260(10 sec.)	°C

The above data are for reference only.

Electrical Characteristics (T_A=25°C unless otherwise specified)

Symbol	Parameter	Test Condition	Min	Typ	Max	Units
V _{RWM}	Reverse Working Voltage	I/O to GND			5.0	V
V _{BR}	Reverse Breakdown Voltage	I _T = 1mA Between I/O and GND	6.0			V
I _R	Reverse Leakage Current	V _{RWM} = 5V Between I/O and GND			100	nA
V _F	Forward Voltage	I _T = 10mA Between I/O and GND			1.2	V
V _C	Clamping Voltage	I _{PP} = 1A, t _p = 8/20μs Between I/O and GND			10	V
		I _{PP} = 4A, t _p = 8/20μs Between I/O and GND			15	V
C _T	Total Capacitance	V _R = 0V, f = 1MHz Between I/O and GND		0.4	0.6	pF
		V _R = 0V, f = 1MHz Between I/O and I/O		0.2	0.3	pF

The above data are for reference only.

ELECTRICAL CHARACTERISTICS CURVE

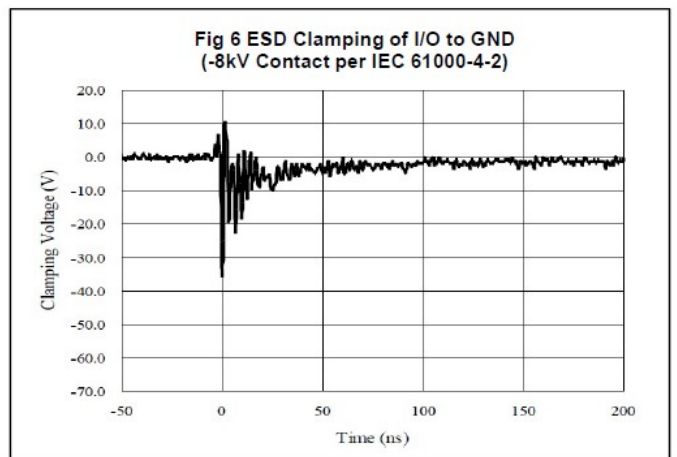
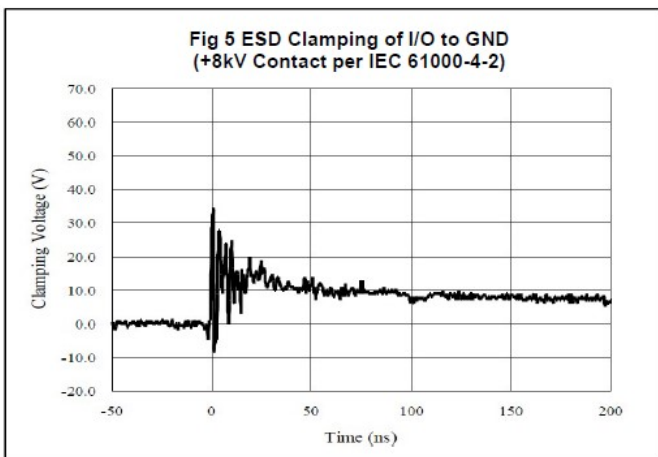
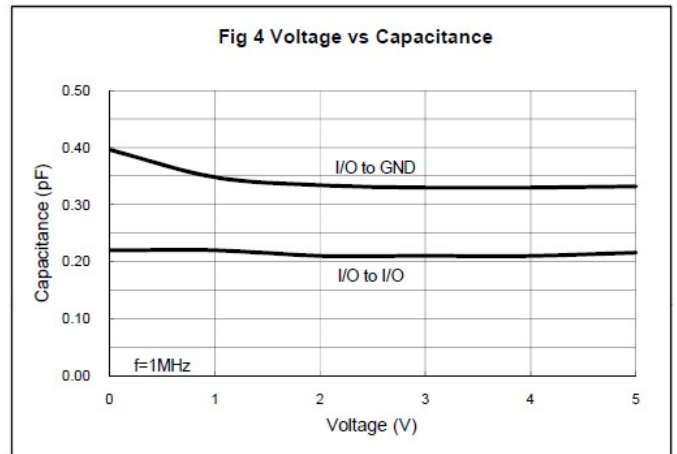
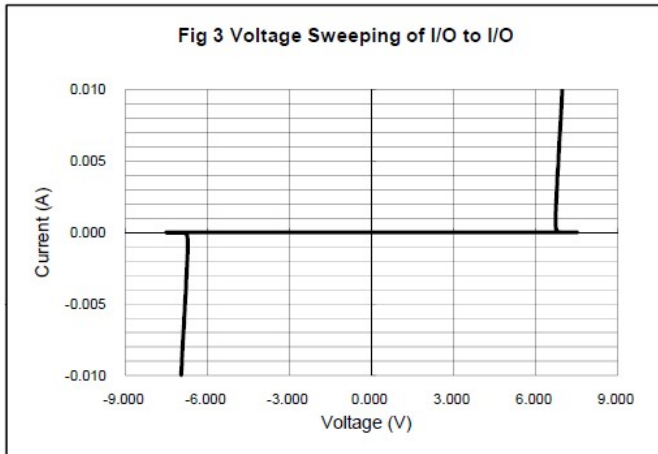
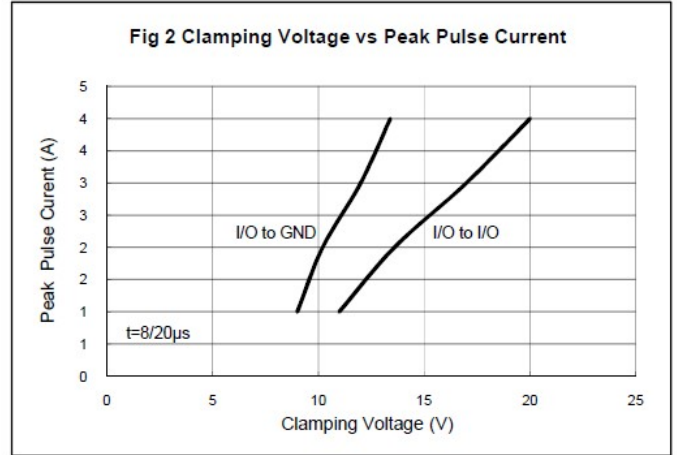
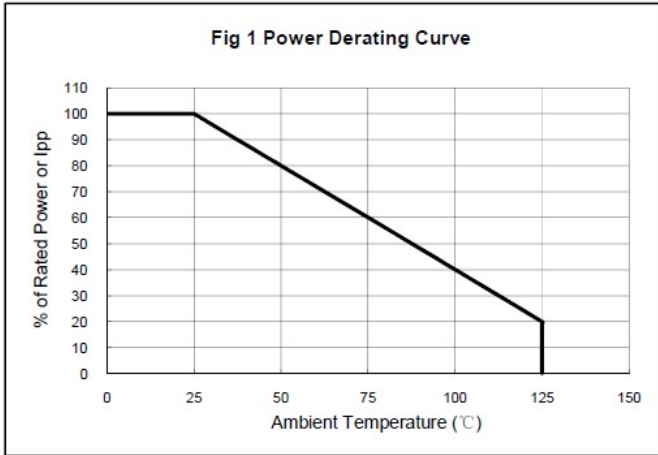

The curve above is for reference only.

Outlitne Drawing

SOT-523 Package Outline Dimensions

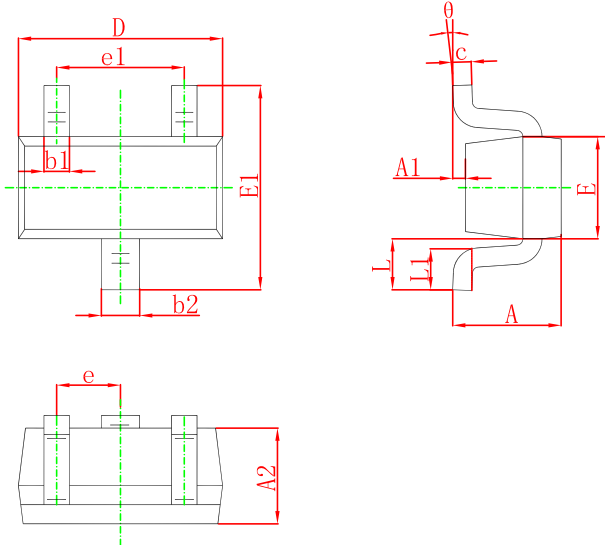

Symbol	Dimensions In Millimeters		Dimensions In Inches	
	Min.	Max.	Min.	Max.
A	0.700	0.900	0.028	0.035
A1	0.000	0.100	0.000	0.004
A2	0.700	0.800	0.028	0.031
b1	0.150	0.250	0.006	0.010
b2	0.250	0.350	0.010	0.014
c	0.100	0.200	0.004	0.008
D	1.500	1.700	0.059	0.067
E	0.700	0.900	0.028	0.035
E1	1.450	1.750	0.057	0.069
e	0.500 TYP.		0.020 TYP.	
e1	0.900	1.100	0.035	0.043
L	0.400 REF.		0.016 REF.	
L1	0.260	0.460	0.010	0.018
θ	0°	8°	0°	8°

Suggested Pad Layout

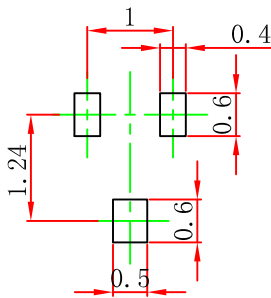

Note:

1. Controlling dimension:in/millimeters.
2. General tolerance: ±0.05mm.
3. The pad layout is for reference purposes only.

SOT-523 Tape and Reel

SOT-523 Embossed Carrier Tape

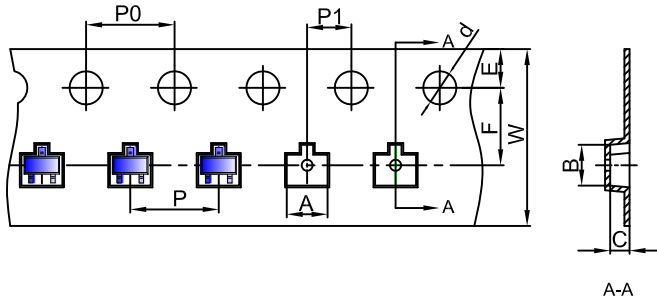

Packaging Description:

SOT-523 parts are shipped in tape. The carrier tape is made from a dissipative (carbon filled) polycarbonate resin. The cover tape is a multilayer film (Heat Activated Adhesive in nature) primarily composed of polyester film, adhesive layer, sealant, and anti-static sprayed agent. These reeled parts in standard option are shipped with 3,000 units per 7" or 17.8cm diameter reel. The reels are clear in color and is made of polystyrene plastic (anti-static coated).

Dimensions are in millimeter										
Pkg type	A	B	C	d	E	F	P0	P	P1	W
SOT-523	1.85	1.85	0.875	Ø1.50	1.75	3.50	4.00	4.00	2.00	8.00

SOT-523 Tape Leader and Trailer

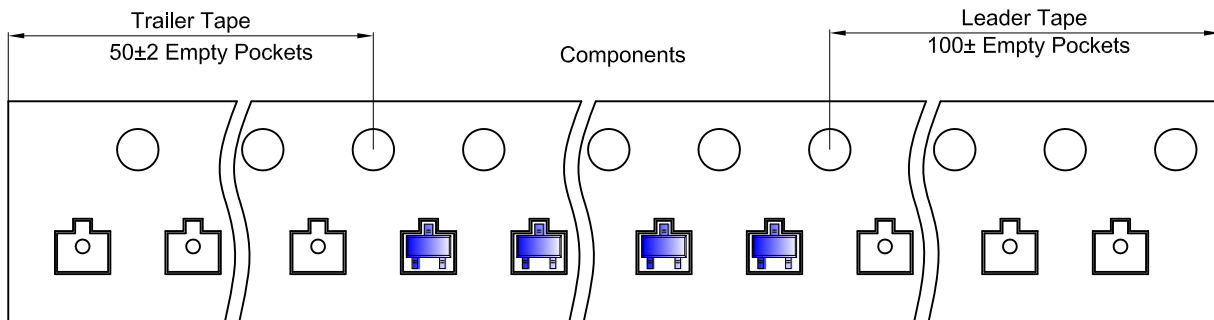

SOT-523 Reel

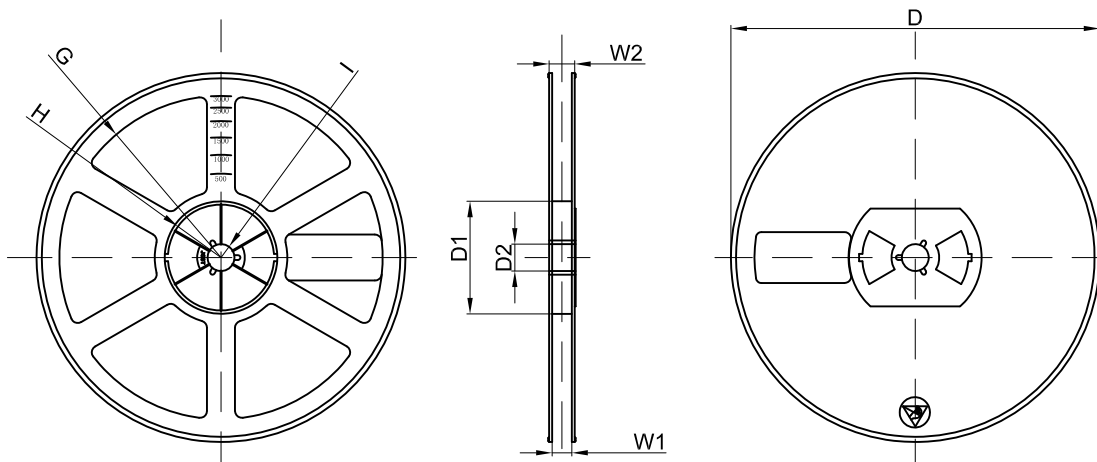

Dimensions are in millimeter								
Reel Option	D	D1	D2	G	H	I	W1	W2
7" Dia	Ø178.00	54.40	13.00	R78.00	R25.60	R6.50	9.50	12.30

REEL	Reel Size	Box	Box Size(mm)	Carton	Carton Size(mm)	G.W.(kg)
3000 pcs	7 Inch	45,000 pcs	203×203×195	180,000 pcs	438×438×220	