

Rev.	Change Description	ECN #	Date

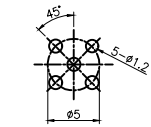

P. C. B 开孔尺寸

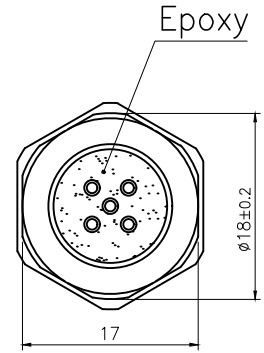
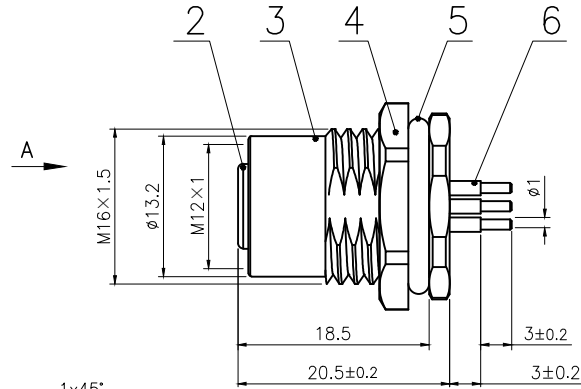
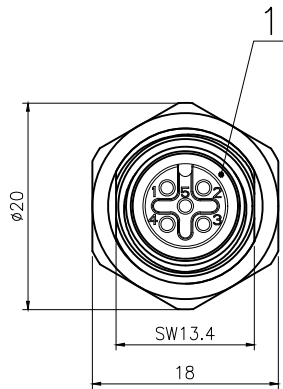
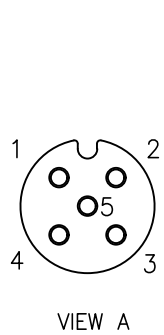
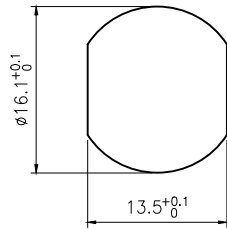

面板开孔尺寸

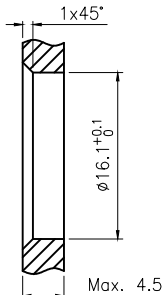

No.	Specification	Material	Treat	Unit	Q'ty
6	M12 1.0 插板式母针	磷铜	镀金	pc	5
5	M12 法兰座外壳专用O型圈 $\phi 16 \times 2$	橡胶	/	pc	1
4	六角螺母M16×1.5 单边倒角	黄铜	镀镍	pc	1
3	M12 板后安装插座母头外壳	黄铜	镀镍	pc	1
2	M12 带倒角常规母胶芯 5芯	尼龙	/	pc	1
1	M12 母头胶芯O型防水圈 $\phi 9 \times \phi 6 \times 1.5$	橡胶	/	pc	1

技术参数

材料

连接方式:	螺纹连接	外壳材料:	黄铜, 镀镍
接线方式:	焊板	接触体材料:	磷铜, 镀金
编码:	A	绝缘体材料:	增强尼龙, 黑色
污染等级:	3	密封材料:	橡胶, 黑色
温度范围:	-40°C ~ +80°C		
防护等级:	IP67		
插拔周期:	≥ 500		
额定电压:	60V AC/DC		
额定电流:	4A		
接触电阻:	$\leq 5 \text{ m}\Omega$		
绝缘电阻:	$\geq 100 \text{ M}\Omega$		

所有材料均符合RoHS要求

GENERAL TOLERANCE (UNLESS SPECIFIED)	DWN	DATE	
	W.M	2022.7.18	
$\leq 10 \pm 0.1$ $< 10 \sim \leq 20 \pm 0.2$ $< 20 \sim \leq 50 \pm 0.5$ Angle $\pm 1^\circ$	CHK	DATE	TITLE M12 板后安装孔型带倒角插座 5芯 PCB板式
	APVD	DATE	
 THIRD ANGLE	UNIT	REV	PART NO
	MM	A	120079-02A000000
	SIZE	SHEET	DRAWING NO
	A4	1 OF 1	M12-CF1-S5