

■ PRODUCT CHARACTERISTICS

VDSS	-30V
$R_{DS(on)Typ}(V_{GS}@=-4.5V)$	64mΩ
$R_{DS(on)Typ}(V_{GS}@=-2.5V)$	80mΩ
ID	-4.2

■ APPLICATIONS

Load/Power Switching
Interfacing Switching

■ FEATURES

Advanced trench process technology
High Density Cell Design For Ultra Low On-Resistance

Symbol

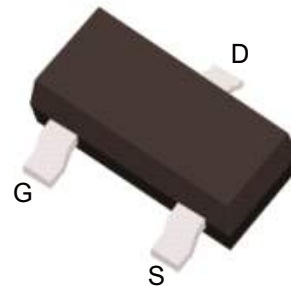
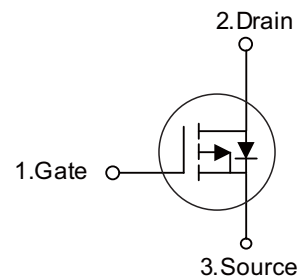

■ ORDER INFORMATION

Order codes		Package	Packing
Halogen-Free	Halogen		
N/A	MOT3401	SOT-23	3000pieces/Reel

■ ABSOLUTE MAXIMUM RATINGS ($T_C = 25^\circ\text{C}$ unless otherwise noted)

PARAMETER	SYMBOL	RATINGS	UNIT
Drain-Source Voltage	V_{DS}	-30	V
Gate-Source Voltage	V_{GS}	± 12	V
Continuous Drain Current	I_D	-4.2	A
Pulsed Drain Current	I_{DM}	-30	A
Maximum Power Dissipation	P_D	1.4	W
		1	W
Operating Junction and Storage Temperature Range	T_J, T_{stg}	-55 to 150	$^\circ\text{C}$
Junction-to-Ambient Thermal Resistance (PCB mounted)	$R_{\theta JA}$	125	$^\circ\text{C/W}$

■ ELECTRICAL CHARACTERISTICS ($T_C=25^{\circ}\text{C}$, unless otherwise specified)

Parameter	Symbol	Test Condition	Min.	Typ.	Max.	Unit
Static						
Drain-Source Breakdown Voltage	BV_{DSS}	$V_{GS} = 0V, I_D = -250\mu A$	-30			V
Drain-Source On-State Resistance	$R_{DS(on)}$	$V_{GS} = -10V, I_D = -4.2A$		42.0	64.0	m Ω
Drain-Source On-State Resistance	$R_{DS(on)}$	$V_{GS} = -4.5V, I_D = -4A$		64.0	75.0	
Drain-Source On-State Resistance	$R_{DS(on)}$	$V_{GS} = -2.5V, I_D = -1A$		80.0	120.0	
Gate Threshold Voltage	$V_{GS(th)}$	$V_{DS} = V_{GS}, I_D = -250\mu A$	-0.7	-1	-1.3	V
Zero Gate Voltage Drain Current	I_{DSS}	$V_{DS} = -24V, V_{GS} = 0V$			-1	μA
Gate Body Leakage	I_{GSS}	$V_{GS} = \pm 12V, V_{DS} = 0V$			± 100	nA
Forward Transconductance	g_{fs}	$V_{DS} = -5V, I_D = -5A$	7	11	—	S
Dynamic						
Total Gate Charge	Q_g	$V_{DS} = 20V, I_D = 5.7A$ $V_{GS} = 10V$		9.4		nC
Gate-Source Charge	Q_{gs}			2		
Gate-Drain Charge	Q_{gd}			3		
Turn-On Delay Time	$t_{d(on)}$	$V_{DD} = 20V, R_L = 20\Omega$ $I_D = 1A, V_{GEN} = 10V$ $R_G = 6\Omega$		6.3		ns
Turn-On Rise Time	t_r			3.2		
Turn-Off Delay Time	$t_{d(off)}$			38.2		
Turn-Off Fall Time	t_f			12		
Input Capacitance	C_{iss}	$V_{DS} = 8V, V_{GS} = 0V$ $f = 1.0\text{ MHz}$		954		pF
Output Capacitance	C_{oss}			115		
Reverse Transfer Capacitance	C_{rss}			77		
Source-Drain Diode						
Max. Diode Forward Current	I_S				-2.2	A
Diode Forward Voltage	V_{SD}	$I_S = 1.8A, V_{GS} = 0V$			-1.0	V

 Note: Pulse test: pulse width $\leq 300\mu s$, duty cycle $\leq 2\%$

■ TYPICAL CHARACTERISTICS

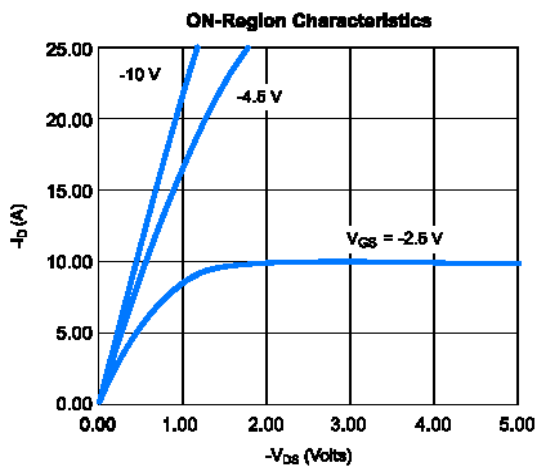
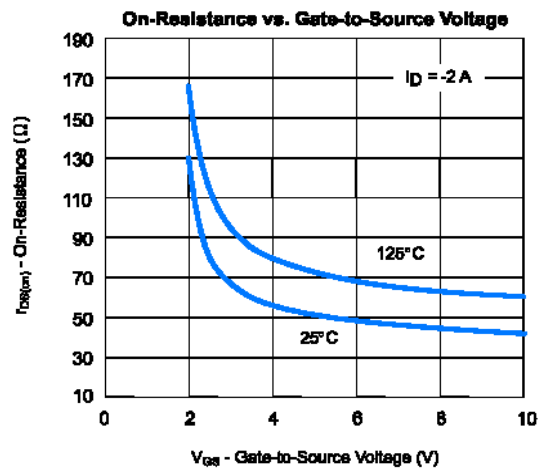
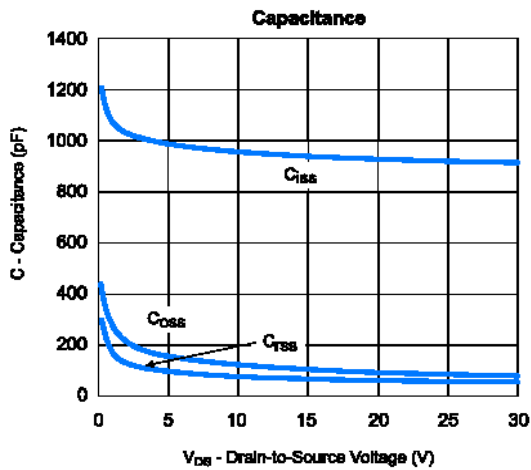
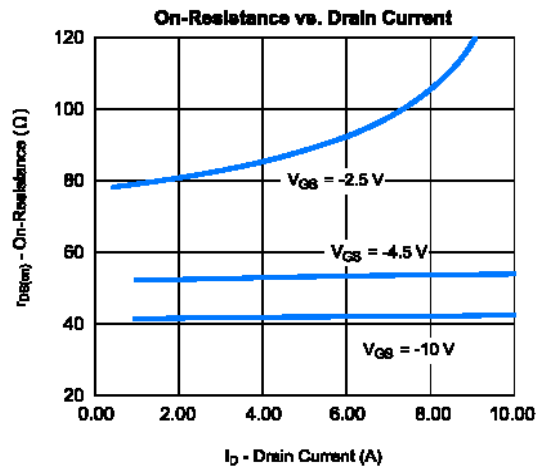
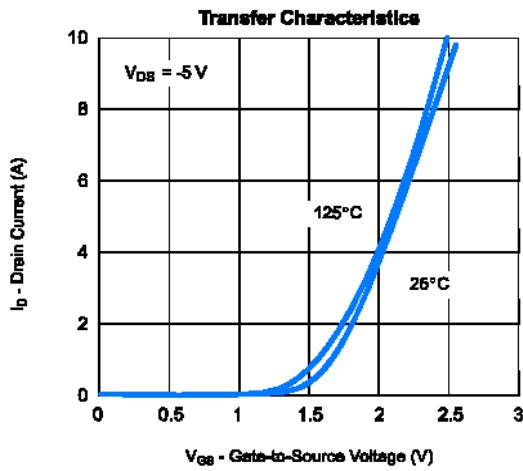

■ SOT-23-3L PACKAGE OUTLINE DIMENSIONS

单位 (UNIT) : mm

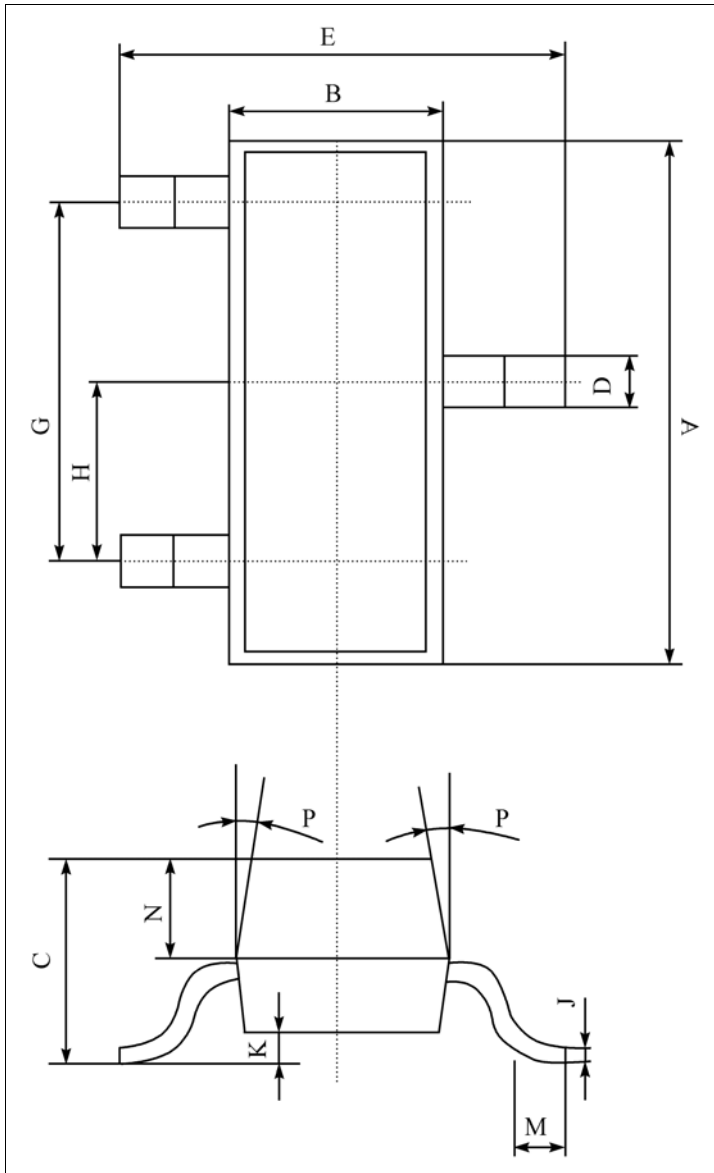

序号	数值及公差
A	2.90±0.10
B	1.30±0.10
C	1.00±0.10
D	0.40±0.10
E	2.40±0.20
G	1.90±0.10
H	0.95±0.05
J	0.13±0.05
K	0.00-0.10
M	≥0.20
N	0.60±0.10
P	7±2°
Packing SOT-23 包装规格 SMD片式表面贴封装 包装方式: 载带卷盘包装 Tape & Reel, 3Kpcs/Reel 每卷数量3000只 (3Kpcs/Reel) 每盒数量45000只 (45Kpcs/BOX) 每箱数量180000只 (180Kpcs/Cartons)	

SOT-23 Tape and reel

SOT-23 Embossed Carrier Tape

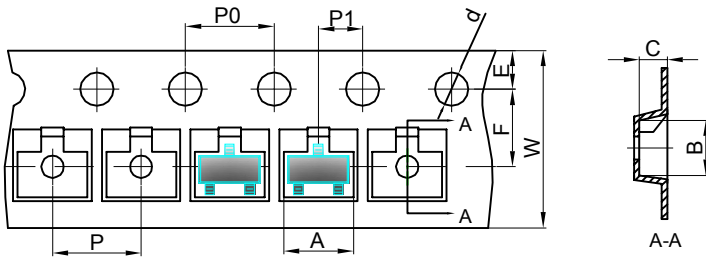

Dimensions are in millimeter										
Pkg type	A	B	C	d	E	F	P0	P	P1	W
SOT-23	3.15	2.77	1.22	Ø1.50	1.75	3.50	4.00	4.00	2.00	8.00

SOT-23 Tape Leader and Trailer

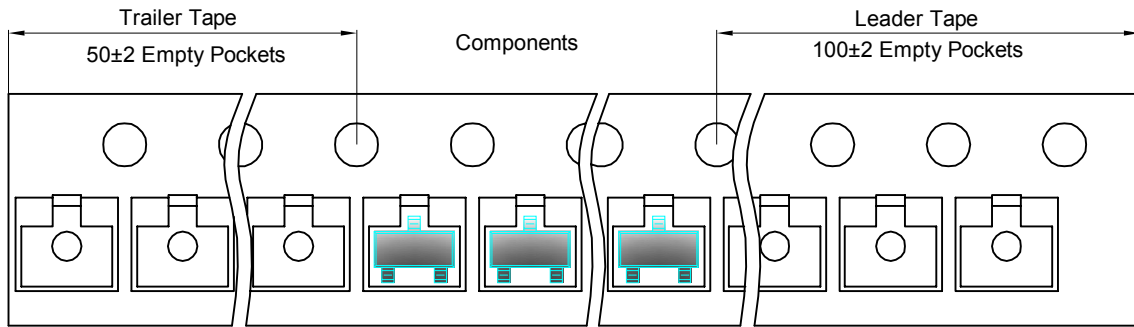

SOT-23 Reel

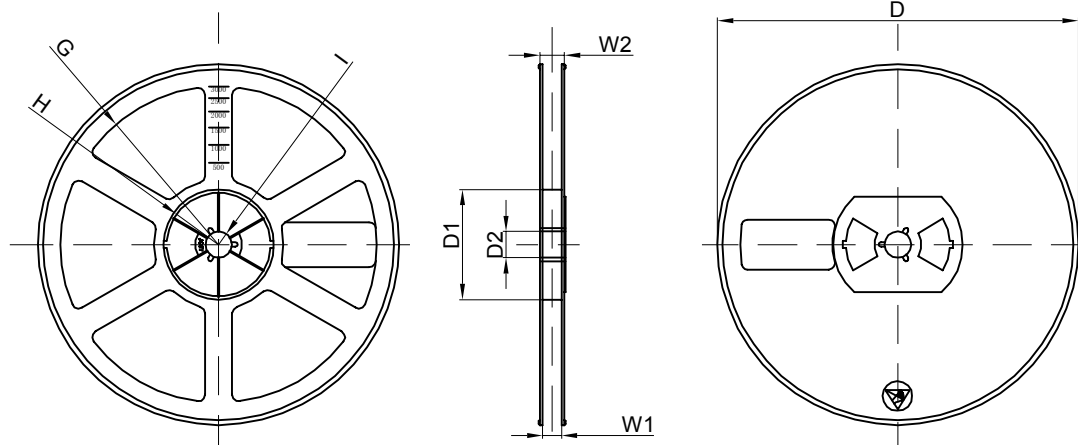

Dimensions are in millimeter								
Reel Option	D	D1	D2	G	H	I	W1	W2
7" Dia	Ø178.00	54.40	13.00	R78.00	R25.60	R6.50	9.50	12.30

REEL	Reel Size	Box	Box Size(mm)	Carton	Carton Size(mm)	G.W.(kg)
3000 pcs	7 inch	45,000 pcs	192×192×193	180,000 pcs	404×404×214	