

■ PRODUCT CHARACTERISTICS

V _{DSS}	30V
R _{DS(on)} Typ(@V _{GS} =4.5V)	9mΩ
R _{DS(on)} Typ(@V _{GS} =10V)	5.5mΩ
I _D	40A

■ APPLICATIONS

DC/DC converter
Ideal for high-frequency switching
and synchronous rectification

■ FEATURES

Very low on-resistance R_{DS(on)}
Good stability and uniformity with high E_{AS}
Pb-free lead plating

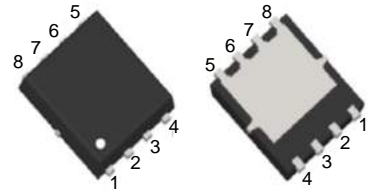
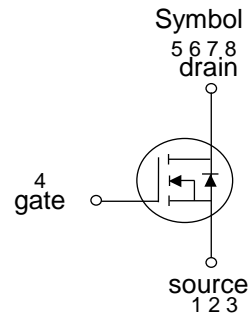

PDFN5X6-8L

■ ORDER INFORMATION

Order codes		Package	Packing
Halogen-free	Halogen		
N/A	MOT3180G	PDFN5X6-8L	5000pieces/Reel

■ ABSOLUTE MAXIMUM RATINGS(T_C=25°C, unless otherwise specified)

Parameter	Symbol	Value	Unit	
Drain-source voltage	V _{DSS}	30	V	
Gate-source voltage	V _{GSS}	±20	V	
Drain current	T _C =25(°C)	I _D	40	A
	T _C =100(°C)	I _D	28.3	A
Pulsed drain current	I _{DM}	160	A	
Avalanche energy single pulsed	E _{AS}	150	mJ	
Power dissipation	P _D	35	W	
Junction temperature	T _J	+150	°C	
Storage temperature	T _{STG}	-55~ +150	°C	

■ ELECTRICAL CHARACTERISTICS (T_C=25°C, unless otherwise specified)

Parameter	Symbol	Condition	Min	Typ	Max	Unit
Off characteristics						
Drain-source breakdown voltage	BV _{DSS}	V _{GS} =0V, I _{DS} =250μA	30	-	-	V
Drain-source leakage current	I _{DSS}	V _{DS} =30V, V _{GS} =0V	-	-	1	μA
Gate-source leakage current	I _{GSS}	V _{GS} = ±20V, V _{DS} =0V	-	-	100	nA
On characteristics						
Gate threshold voltage	V _{GS(th)}	V _{DS} =V _{GS} , I _{DS} =250μA	1	-	2.5	V
On-state characteristics	R _{Ds(ON)}	V _{GS} =10V, I _D =20A	-	5.5	8	mΩ
		V _{GS} =4.5V, I _D =20A	-	9	13	mΩ
Forward transconductance	g _{FS}	V _{DS} =10V, I _D =20A	10	-	-	S
Dynamic characteristics						
Input capacitance	C _{iss}	V _{GS} =0V, V _{DS} =15V f=1MHz	-	1650	-	pF
Out capacitance	C _{oss}		-	205	-	pF
Reverse transfer capacitance	C _{rss}		-	177	-	pF
Switching characteristics						
Total gate charge	Q _g	V _{GS} =10V, V _{DS} =15V I _D =20A	-	32.3	-	nC
Gate-source charge	Q _{gs}		-	4.9	-	nC
Gate-drain charge	Q _{gd}		-	6.9	-	nC
Turn-on delay time	t _{d(on)}	V _{DD} =15V, I _D =20A R _G =6Ω, V _{GS} =10V	-	9	-	nS
Turn-on rise time	t _r		-	8	-	nS
Turn-off delay time	t _{d(off)}		-	28	-	nS
Turn-off fall time	t _f		-	5	-	nS
Source-drain diode ratings and characteristics						
Continuous diode forward current	I _{SD}		-	-	40	A
Diode forward current	V _{SD}	V _{GS} =0V, I _{SD} =20A	-	-	1.2	V
Reverse recovery time	t _{rr}	I _F =20A di/dt=100A/us	-	27	-	nS
Reverse recovery charge	Q _{rr}		-	20	-	nC

■ TYPICAL CHARACTERISTICS

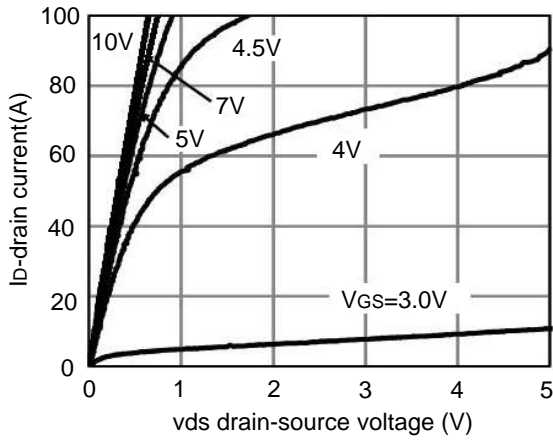

Fig.1 output characteristics

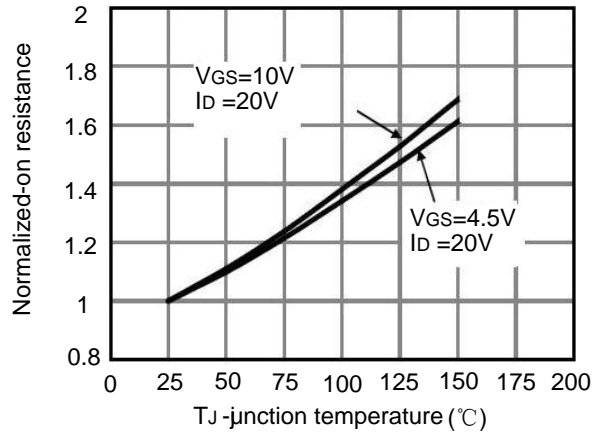

Fig.2 rdson-junction temperature

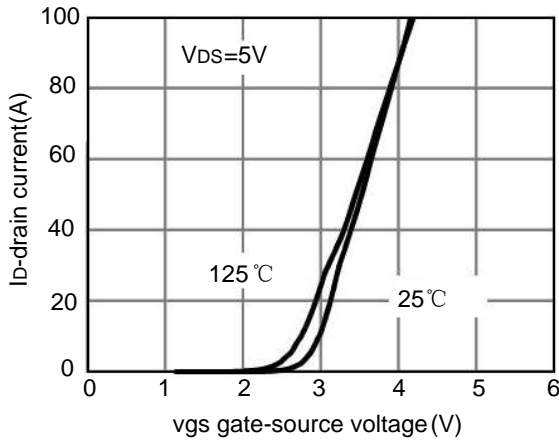

Fig.3 transfer characteristics

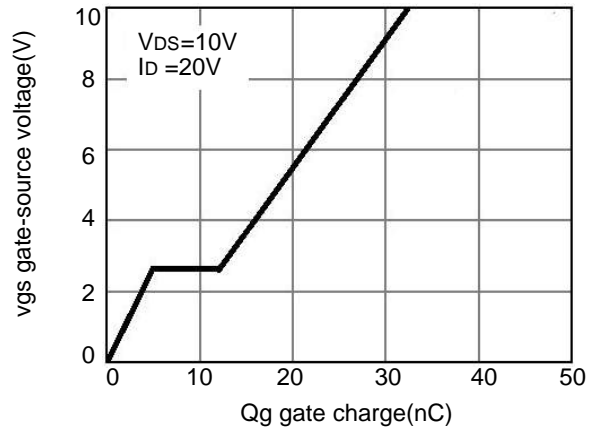

Fig.4 gate charge

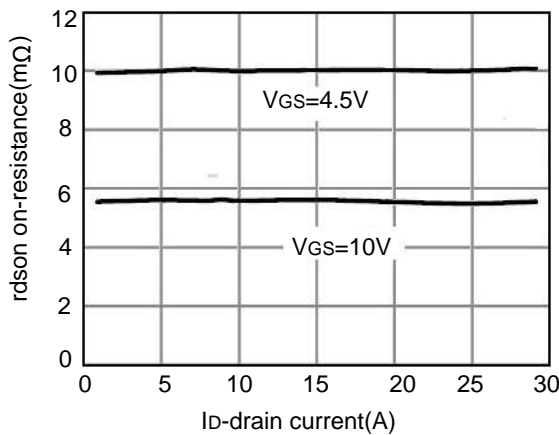

Fig.5 rdson-drain current

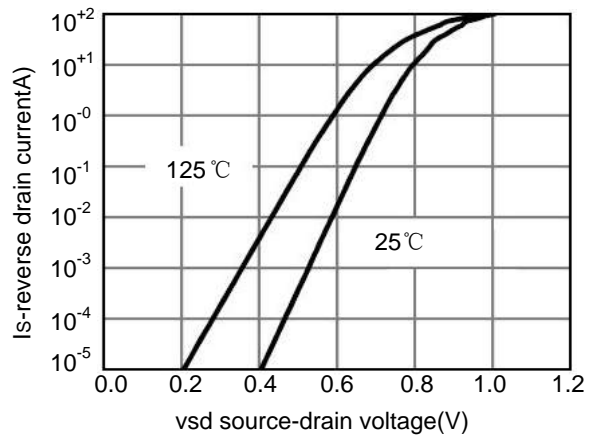

Fig.6 source-drain diode forward

■ TYPICAL CHARACTERISTICS(Cont.)

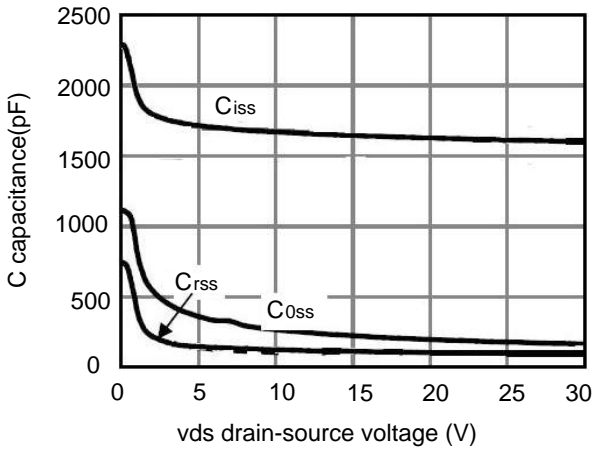

Fig.7 capacitance vs vds

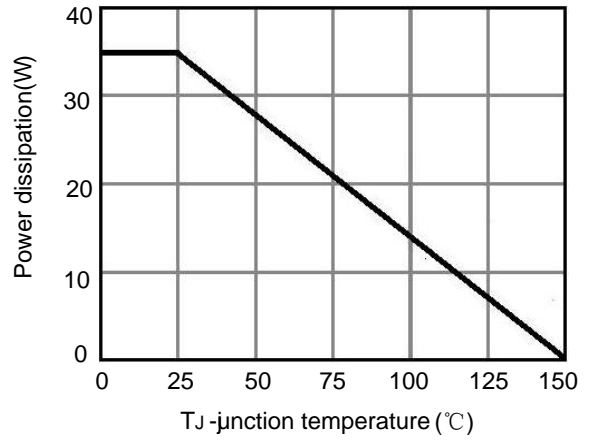

Fig.8 power de-rating

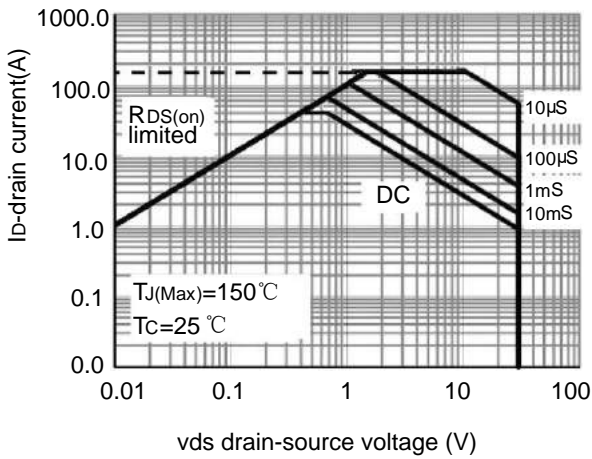

Fig.9 safe operation area

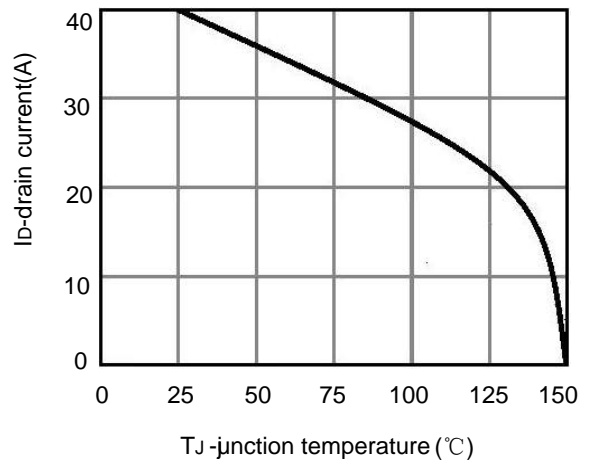
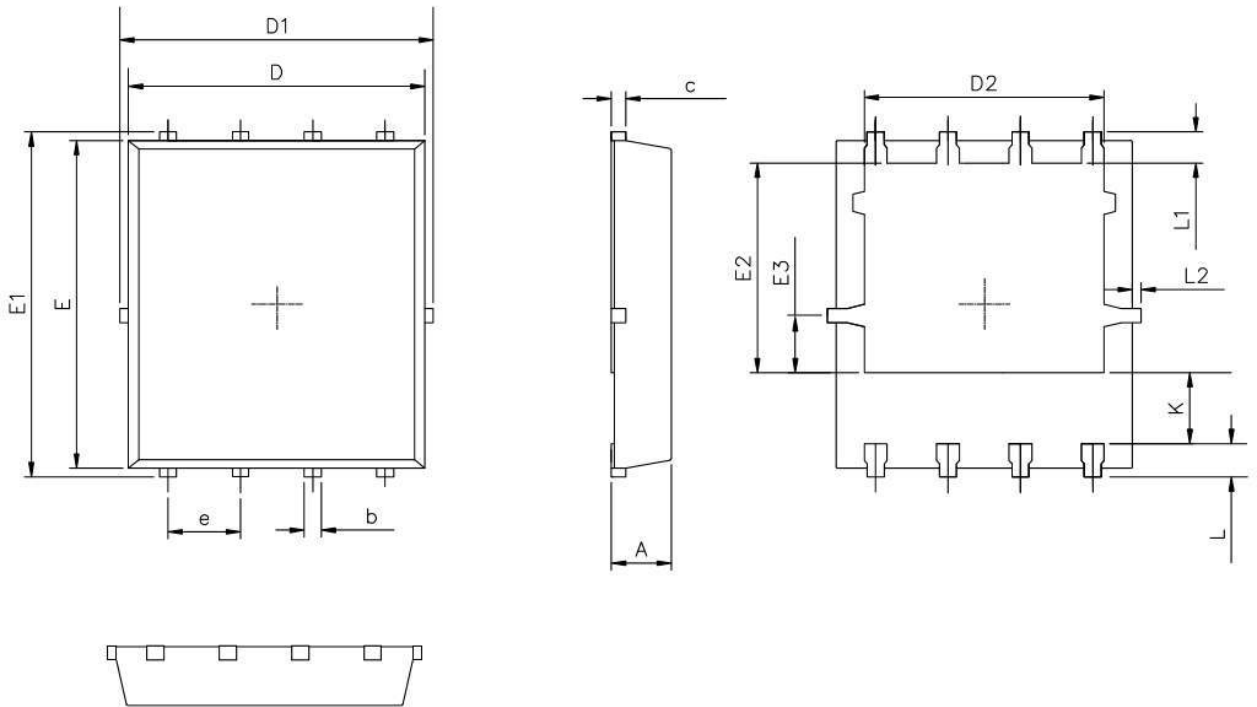
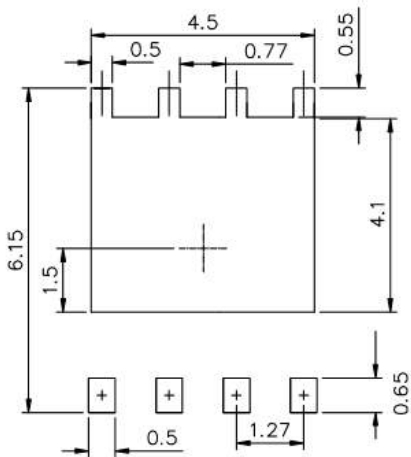

Fig.10 id current-junction temperature

■ PDFN5X6-8L PACEAGE MECHANICAL DATA



RECOMMENDED LAND PATTERN



UNIT:mm

	MIN	NOM	MAX
A	0.90	1.00	1.10
b	0.25	0.35	0.50
c	0.10	0.20	0.30
D	4.80	5.00	5.30
D1	4.90	5.10	5.50
D2	3.92	4.02	4.20
E	5.65	5.75	5.85
E1	5.90	6.05	6.20
E2	3.325	3.525	3.775
E3	0.80	0.90	1.00
e		1.27	
L	0.40	0.55	0.70
L1		0.65	
L2	0.00		0.15
K	1.00	1.30	1.50