

公差/General tolerances(mm)										
0	>0	>6	>10	>18	>30	>50	>80	>120	>250	>500
-	0.2	0.3	0.4	0.5	0.6	0.8	1.0	1.5	2.0	3.0
3	6	10	18	30	50	80	120	180	250	400
0.12	0.18	0.25	0.35	0.50	0.70	1.00	1.50	2.00	3.00	4.50

PCB LAYOUT (02-04P)

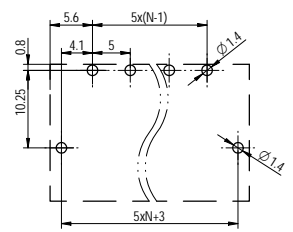

PCB LAYOUT (05-14P)

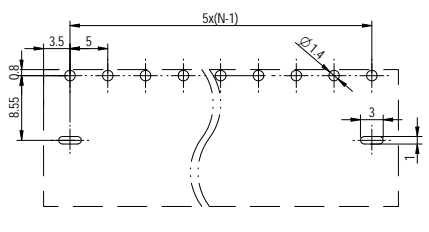

02P

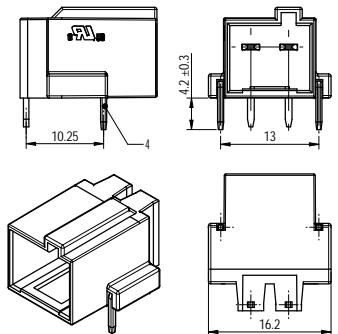

03P

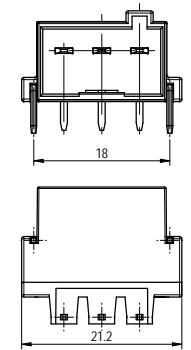

04P

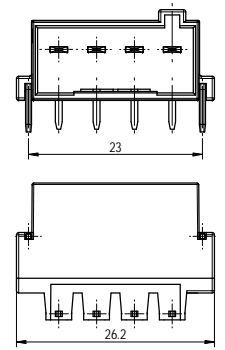

05P

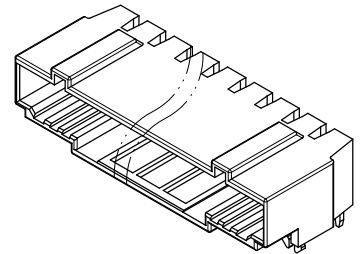
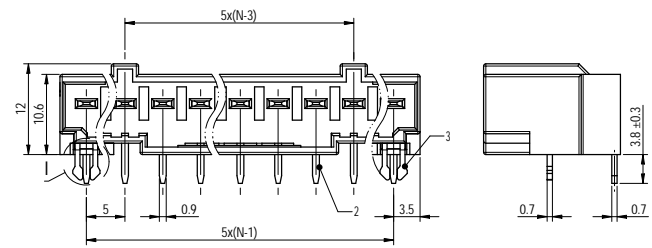
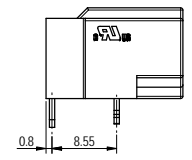
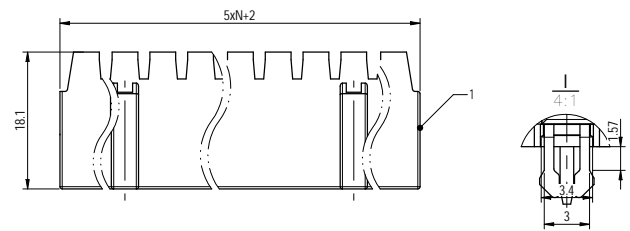
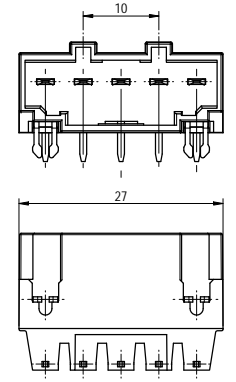

ITEM	NAME OF PART	MATERIAL	NOTES
4	Pin	Copper alloy	Sn plated
3	Mount	Stainless Steel	/
2	Pin header	Copper	Au Plated Area
1	Housing	PA66+GF	UL94V-0

UL 标准/UL Standard	B	C	D
额定电压/电压/Rated Voltage(V)/Current(A)	300/14.5	/	300/10
IEC 标准/IEC Standard			
污染等级/Contamination Category/污染等级/ Pollution Degree	III/3	III/2	II/2
额定电压/电压/Rated Voltage(V)/Current(A)	/	/	/
额定脉冲电压/电压/Rated Voltage(V)/Current(A)	/	/	/
额定脉冲电压/电压/Rated Voltage(V)/Current(A)	/	/	/
材料/材料/ Material	S.0/N-02-14P		
使用温度范围/Operating temperature(°C)	-40 ~ +125		
符合RoHS环保要求/Conform to RoHS	Yes		
标准颜色编号/Standard color number: PANTONE / RAL	/		

DRAGON

MATERIAL: SURFACE COLOR: 00 MAT STATUS: 数量

APPR: 王备华 2023.07.01 NAME: 9EDGRC-5, 0-XXP-1Y-100Z (H)

CHKD: 陈彦华 2023.07.01

DRWT: 陈彦华 2023.07.01

DATE: 2023.07.01

DRAWING NO: 200177180 TYPE: CUSTOMER DRAWING DRAWING STATUS: 已发布 SCALE: 2:1 SHEET: 1/1

REV	BY	DATE	DESCRIPTION	审核	DATE	DATE	DATE
00							