

MECHANICAL DATA

**GOLD METALLISED  
MULTI-PURPOSE SILICON  
DMOS RF FET  
60W – 28V – 175MHz  
SINGLE ENDED**

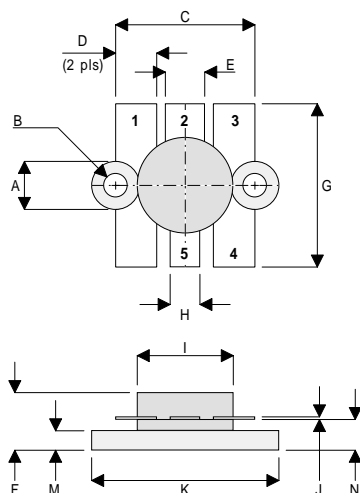

DT

PIN 1 SOURCE (COMMON) PIN 2 GATE  
 PIN 3 SOURCE (COMMON) PIN 4 SOURCE (COMMON)  
 PIN 5 DRAIN

DIM	mm	Tol.	Inches	Tol.
A	6.35 DIA	0.13	0.250 DIA	0.005
B	3.17 DIA	0.13	0.125 DIA	0.005
C	18.41	0.25	0.725	0.010
D	5.46	0.13	0.215	0.005
E	5.21	0.13	0.205	0.005
F	7.62	MAX	0.300	MAX
G	21.59	0.38	0.850	0.015
H	3.94	0.13	0.155	0.005
I	12.70	0.13	0.500	0.005
J	0.13	0.03	0.005	0.001
K	24.76	0.13	0.975	0.005
M	2.59	0.13	0.102	0.005
N	4.06	0.25	0.160	0.010

FEATURES

- SIMPLIFIED AMPLIFIER DESIGN
- SUITABLE FOR BROAD BAND APPLICATIONS
- LOW  $C_{rss}$
- SIMPLE BIAS CIRCUITS
- LOW NOISE
- HIGH GAIN – 16 dB MINIMUM

APPLICATIONS

- HF/VHF COMMUNICATIONS  
from 1 MHz to 175 MHz

ABSOLUTE MAXIMUM RATINGS ( $T_{case} = 25^{\circ}C$  unless otherwise stated)

$P_D$	Power Dissipation	117W
$BV_{DSS}$	Drain – Source Breakdown Voltage	70V
$BV_{GSS}$	Gate – Source Breakdown Voltage	$\pm 20V$
$I_{D(sat)}$	Drain Current	15A
$T_{stg}$	Storage Temperature	$-65$ to $150^{\circ}C$
$T_j$	Maximum Operating Junction Temperature	$200^{\circ}C$

Semelab Plc reserves the right to change test conditions, parameter limits and package dimensions without notice. Information furnished by Semelab is believed to be both accurate and reliable at the time of going to press. However Semelab assumes no responsibility for any errors or omissions discovered in its use. Semelab encourages customers to verify that datasheets are current before placing orders.

## ELECTRICAL CHARACTERISTICS (T<sub>case</sub> = 25°C unless otherwise stated)

Parameter	Test Conditions	Min.	Typ.	Max.	Unit
B <sub>V</sub> DSS Drain-Source Breakdown Voltage	V <sub>GS</sub> = 0      I <sub>D</sub> = 100mA	70			V
I <sub>D</sub> SS Zero Gate Voltage Drain Current	V <sub>DS</sub> = 28V      V <sub>GS</sub> = 0			1	mA
I <sub>G</sub> SS Gate Leakage Current	V <sub>GS</sub> = 20V      V <sub>DS</sub> = 0			1	μA
V <sub>GS(th)</sub> Gate Threshold Voltage *	I <sub>D</sub> = 10mA      V <sub>DS</sub> = V <sub>GS</sub>	1		7	V
g <sub>fs</sub> Forward Transconductance *	V <sub>DS</sub> = 10V      I <sub>D</sub> = 3A	2.4			S
G <sub>PS</sub> Common Source Power Gain	P <sub>O</sub> = 60W	16			dB
η Drain Efficiency	V <sub>DS</sub> = 28V      I <sub>DQ</sub> = 0.3A	50			%
VSWR Load Mismatch Tolerance	f = 175MHz	20:1			—
C <sub>iss</sub> Input Capacitance	V <sub>DS</sub> = 0      V <sub>GS</sub> = -5V      f = 1MHz			180	pF
C <sub>oss</sub> Output Capacitance	V <sub>DS</sub> = 28V      V <sub>GS</sub> = 0      f = 1MHz			90	pF
C <sub>rss</sub> Reverse Transfer Capacitance	V <sub>DS</sub> = 28V      V <sub>GS</sub> = 0      f = 1MHz			7.5	pF

\* Pulse Test:    Pulse Duration = 300 μs , Duty Cycle ≤ 2%

## HAZARDOUS MATERIAL WARNING

The ceramic portion of the device between leads and metal flange is beryllium oxide. Beryllium oxide dust is highly toxic and care must be taken during handling and mounting to avoid damage to this area.

**THESE DEVICES MUST NEVER BE THROWN AWAY WITH GENERAL INDUSTRIAL OR DOMESTIC WASTE.**

## THERMAL DATA

R <sub>THj-case</sub>	Thermal Resistance Junction – Case	Max. 1.5°C / W
-----------------------	------------------------------------	----------------

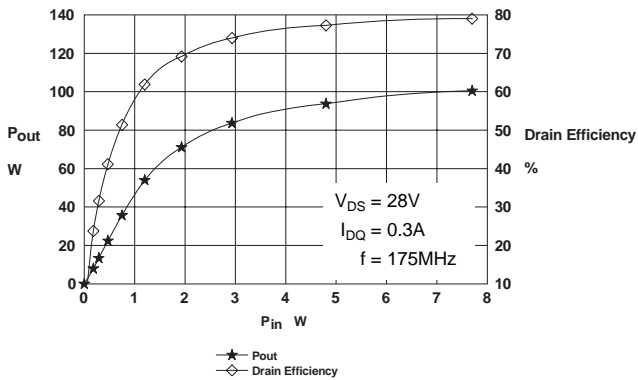

**Figure 1 – Power Output and Efficiency vs. Power Input.**

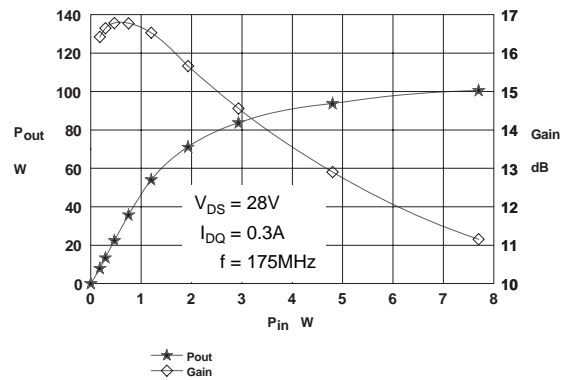

**Figure 2 – Power Output & Gain vs. Power Input.**

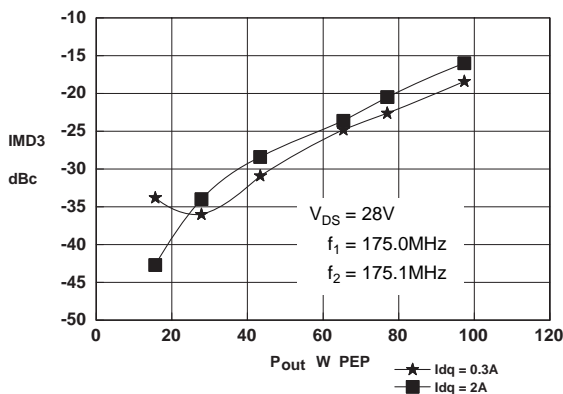

**Figure 3 – IMD vs. Output Power.**

## D1023UK OPTIMUM SOURCE AND LOAD IMPEDANCE

Frequency MHz	Z <sub>S</sub> Ω	Z <sub>L</sub> Ω
175MHz	2.0 – j4.3	3.7 – j4.5

### Typical S Parameters

! V<sub>DS</sub> = 28V, I<sub>DQ</sub> = 0.3A

# MHz S M A R 50

!Freq MHz	S11		S21		S12		S22	
	mag	ang	mag	ang	mag	ang	mag	ang
70	0.83	-156.8	6.9	59.9	0.018	-16.7	0.65	-137.0
100	0.87	-163.3	4.3	46.9	0.012	-15.5	0.75	-147.2
150	0.91	-171.0	2.3	31.5	0.007	37.1	0.84	-159.7
200	0.93	-177.6	1.4	22.6	0.013	81.0	0.90	-168.8
250	0.95	177.6	0.9	14.3	0.022	86.6	0.93	-175.0
300	0.97	173.6	0.7	10.5	0.032	86.9	0.95	179.5
350	0.96	168.6	0.5	4.0	0.039	80.0	0.96	175.3
400	0.98	165.0	0.4	3.9	0.048	80.0	0.98	172.0
450	0.98	161.9	0.3	2.9	0.053	77.5	0.98	169.8
500	0.97	159.3	0.3	2.1	0.064	74.8	0.97	166.5

Semelab Plc reserves the right to change test conditions, parameter limits and package dimensions without notice. Information furnished by Semelab is believed to be both accurate and reliable at the time of going to press. However Semelab assumes no responsibility for any errors or omissions discovered in its use. Semelab encourages customers to verify that datasheets are current before placing orders.

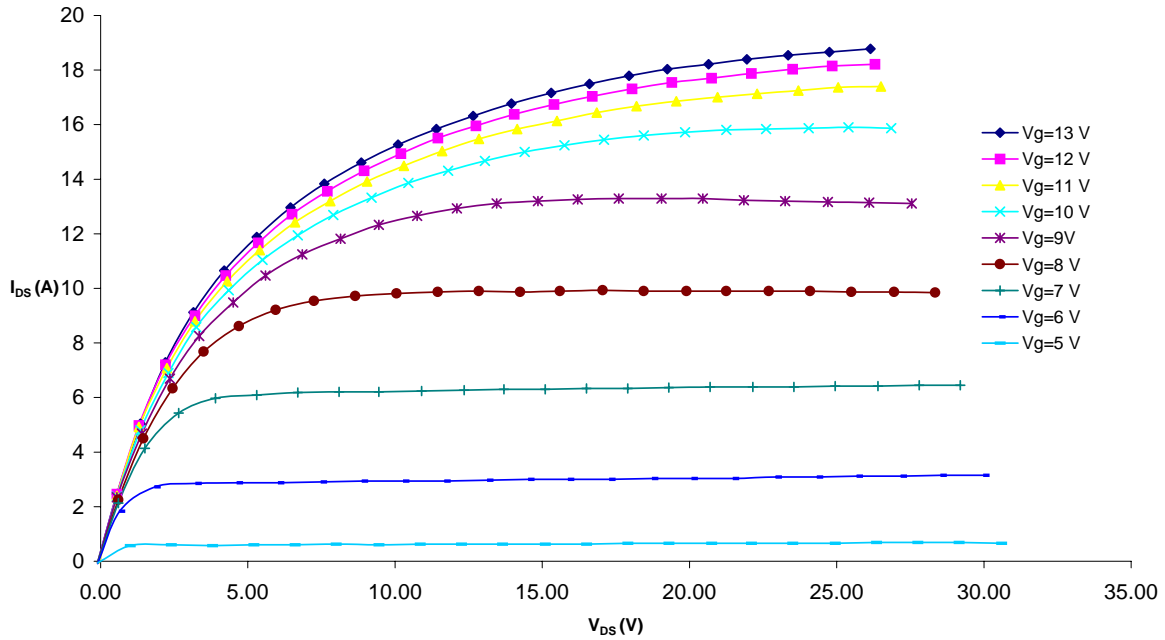

Figure 4 – Typical IV Characteristics.

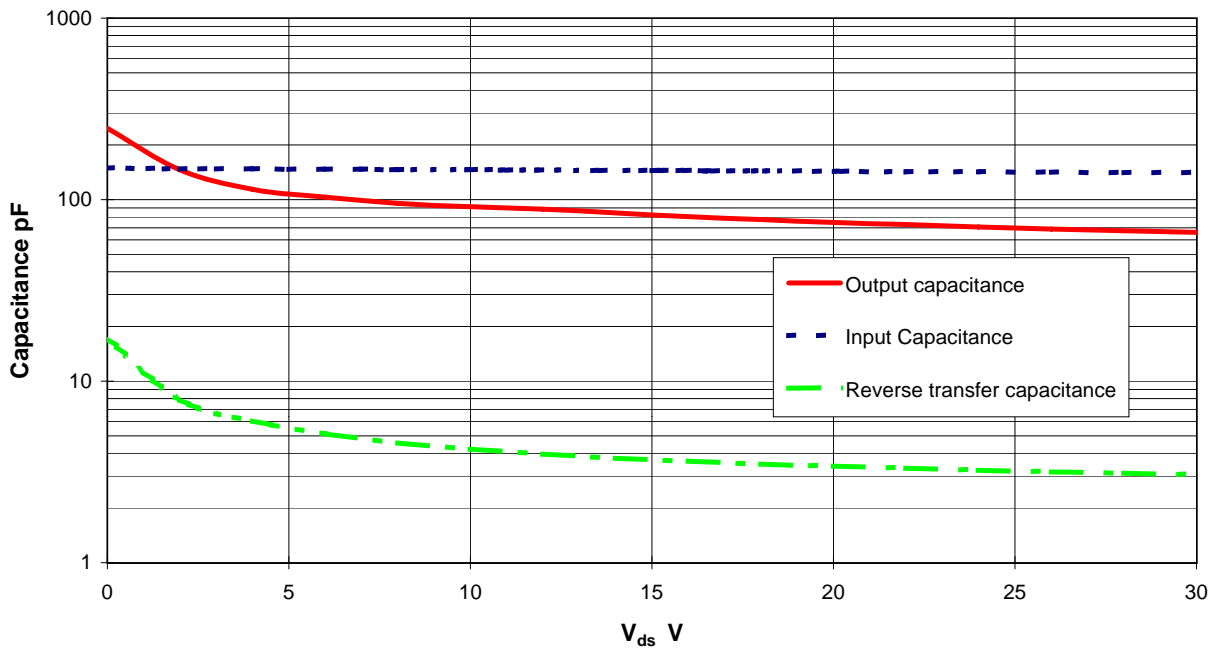
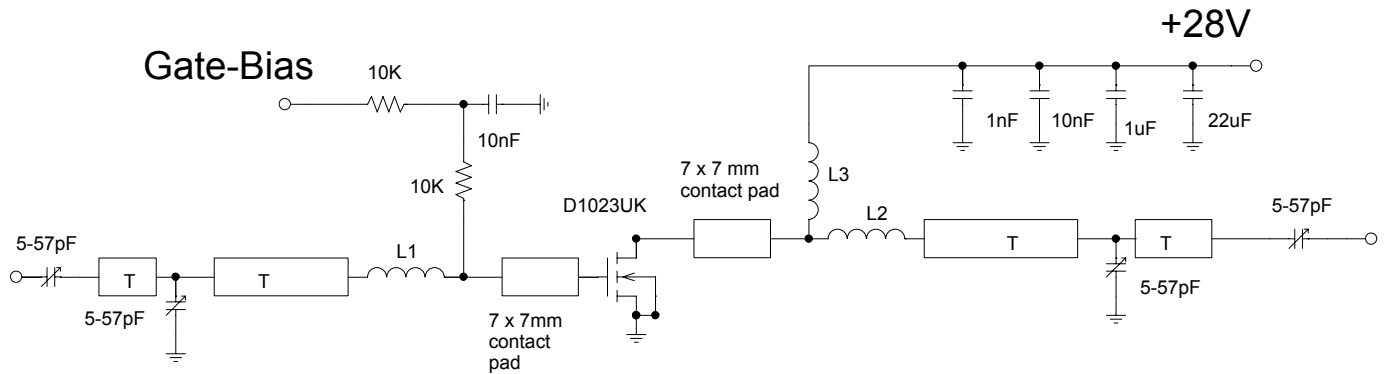

Figure 5 – Typical CV Characteristics.

Semelab Plc reserves the right to change test conditions, parameter limits and package dimensions without notice. Information furnished by Semelab is believed to be both accurate and reliable at the time of going to press. However Semelab assumes no responsibility for any errors or omissions discovered in its use. Semelab encourages customers to verify that datasheets are current before placing orders.



## D1023UK 175MHz TEST FIXTURE

Substrate 1.6mm PTFE/ glass, Er= 2.5  
All microstrip lines W= 4.4mm

T1 8mm  
T2 22mm  
T3 18mm  
T4 4.5mm

L1 Hairpin loop 16swg 15.5mm dia.  
L2 Hairpin loop 16swg 10mm dia.  
L3 11 turns 18swg enamelled copper wire, 10mm i. d.