

禁止使用1级环境管理物质
Non-use Warranty for Level 1 Prohibited Substances in Product.
HF (Halogen Free)

版本 ISSUE	变更通知单号 ECN NO	变更内容 DESCRIPTION	日期 DATE
A/0	NEW RELEASE	NEW RELEASE	2023.02.25

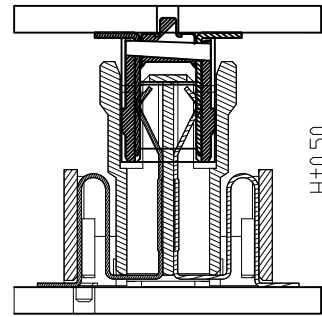
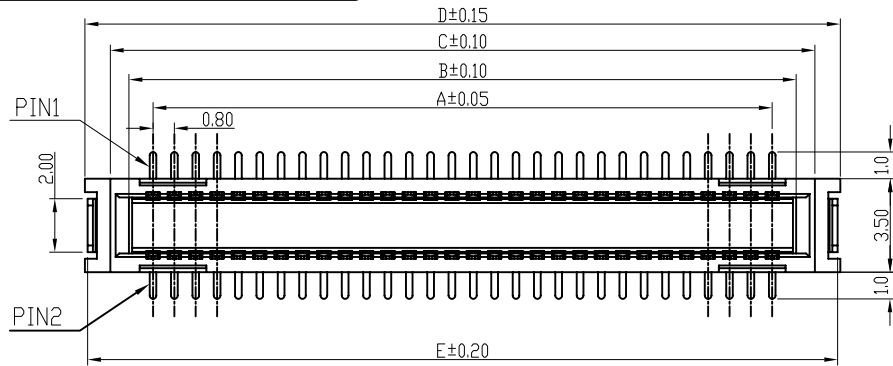

NOTES:
MATERIAL:
1.HOUSING:LCP UL94V-0 BLACK
2.CONTACT:PHOSPHOR BRONZE
PLATING: GOLD FLASH ON THE CONTACT AREA
UNDER PLATING:50~120U" NICKEL OVERALL

ELECTRICAL:
1.CURRENT RATING:0.5A
2.VOLTAGE RATING:50V
3.CONTACT RESISTANCE:60 MILLI-OHMS MAX
4.WITHSTANDING VOLTAGE:250V
5.CONTACT RESISTANCE:100MQ MAX
6.INSULATION RESISTANCE:500MQ MIN
7.FLOATING RANGE ±0.5MM IN X, Y, Z DIRECTIONS

ENVIRONMENTAL:
1. OPERATING TEMPERATURE:-40°C TO +125°C.

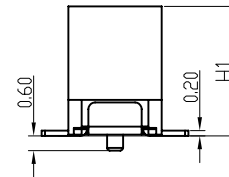
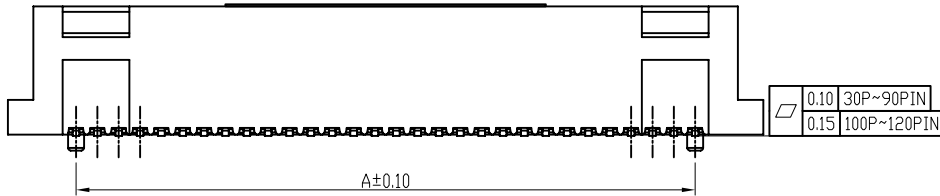

Plug Height Dim HI	Mating Height Dim H
4.80	9.75
6.80	11.75
7.80	12.75
9.05	14.00

料号编排说明:W080 12 M * 0** G1 B R.

产品分类码
W080:0.8Pitch
产品系列码
12:0.8Pitch 浮动式
公母座
M:公座
系列高度
A: 9.05H
B: 7.80H
C: 6.80H
D: 4.80H

包装码
R:载带贴MyIar
电镀
G1: GOLD FLASH PLATING ON SOLDER AREA.
GOLD FLASH PLATING ON CONTACT AREA.

Pin位码
040:40Pin

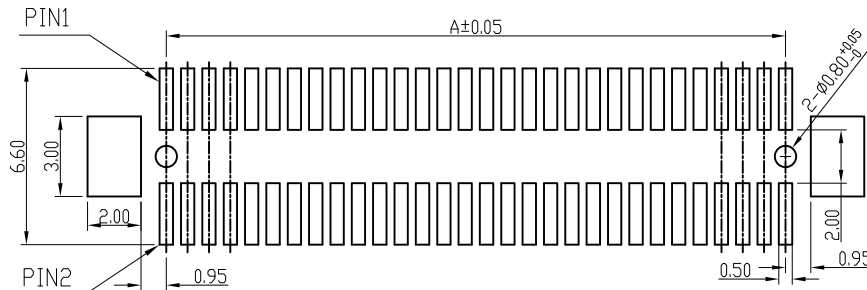
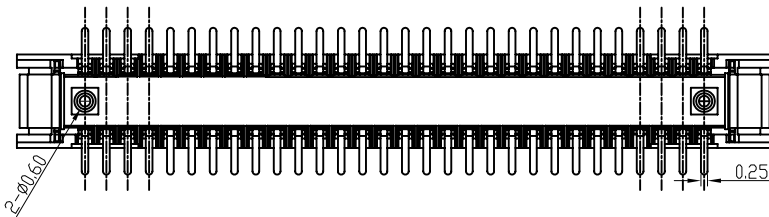

Recommended PC board pattern
(TOP VIEW)

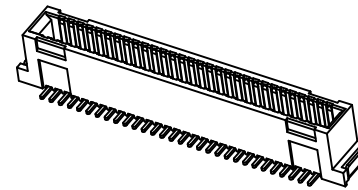

CKT	A	B	C	D	E
30	11.2	13.0	14.4	16.3	16.1
*40	15.2	17.0	18.4	20.3	20.1
50	19.2	21.0	22.4	24.3	24.1
*60	23.2	25.0	26.4	28.3	28.1
70	27.2	29.0	30.4	32.3	32.1
*80	31.2	33.0	34.4	36.3	36.1
90	35.2	37.0	38.4	40.3	40.1
100	39.2	41.0	42.4	44.3	44.1
110	43.2	45.0	46.4	48.3	48.1
120	47.2	49.0	50.4	52.3	52.1

C+T 东莞市昶通通讯科技有限公司
CONNECTOR Dongguan Changtong Communication Technology Co., Ltd

品名 TITLE	MSA 0.80 BTB PLUG	Unless otherwise specified tolerances are 未标注公差	类型 TYPE	业务图
制图 DESIGNER	Billy2023.02.25	X. X ±0.30 X. X ±0.25 X. XX ±0.20 X. XXX ±0.10 ANGLES ±2°	产品料号 PRODUCT P/N	W08012M*0**G1BR
审核 CHECKED	Aaron2023.02.25		材质 MATERIAL	/
核准 APPROVED	Aaron2023.02.25	投影方法 PROJECTION	比例 SCALE	1:1 张次 SHF. NO. 1/2