

SPECIFICATION FOR APPROVAL

承 認 書

CUSTOMER

客戶名稱：

NUMBER

編號： LH2918-047

PART NO.

品 名： CPQ2918-4R7M

QUANTITY

數量： 5PCS

DESCRIPTION

型 號： High Current Power Inductor

DATE

日期： 2023-09-06

CUSTOMER PART NO.

客戶料號：

NOTE

注解：

APPROVAL SIGNATURE

客戶承認簽章

Approved By 核 准	Checked By 审 查	Drawn By 制 作
李 庆 辉	苏 高 峰	劳 水 花

深圳市柯爱亚电子有限公司

Shenzhen Ceaiya Electronics Co., Ltd.

深圳地址： 深圳市龙华区观湖街道鹭湖社区观盛二路 5 号捷顺科技中心 B706

东莞地址： 东莞清溪镇青滨东路 105 号力合紫荆智能制造中心 10 栋一单元

Http://www.szceaiya.com Tel: 0769-89333213



CUSTOMER:	SPECIFICATIONS (Revisions)	TYPE CPQ2918-4R7M
-----------	-------------------------------	----------------------

History of change

Rev.	Effective Date	Changed Contents	Change reasons	Approved By
A0	2023-09-06	New release	/	

Note :	Spec. No. LH2918-047 1/4
--------	--------------------------------



SPECIFICATIONS

TYPE:
CPQ2918-4R7M

1. Scope

This specification apply for CPQ2918 of power inductors

2. Appearance

2-1. Dimensions(mm)

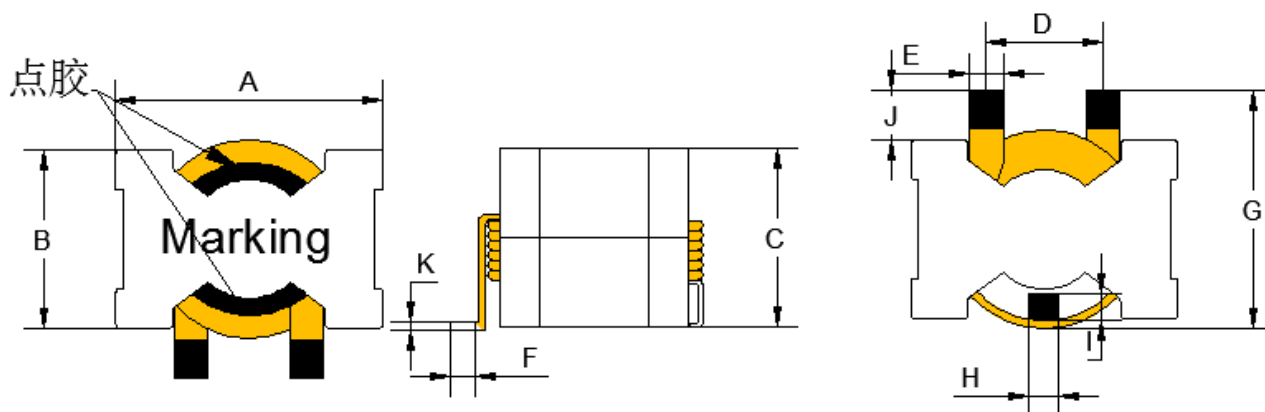

A	B	C	D	E	F	G	H	I	J	K
28.0Max	19.4Max	18.5Max	11.0±0.5	3.8±0.3	3.8Min	27.0Max	3.1 Ref	2.8 Ref	6.5±1.0	0.8Ref.

3. Coils Specification

3-1. Connection (Bottom View)



“S” is winding start

LEAD-FREE



3-2. Electrical characteristics

Part number 料号	Inductance 电感量 uH	DC resistance 直流电阻 mΩ	DC saturation current 直流饱和电流 A Max.	Temperature rise current 温升电流 A Max.
CPQ2918-4R7M	4.7±20%	2.4 ± 15%	60 (ΔL≤30%)	28 (ΔT≤50℃)

Remark

- ※ Inductance is measured with a LCR meter 4284A or equivalent.
Test frequency at 100kHz/0.1V
- ※ DC resistance is measured with 16502 Milliohm Meter, or equivalent.
Reference ambient temperature 25℃

Note : 产品平贴度管控≤0.15mm	Spec. No. LH2918-047
--------------------------	-------------------------

SPECIFICATIONS

TYPE:
CPQ2918-4R7M

4. Recommended reflow condition

推荐波峰焊曲线

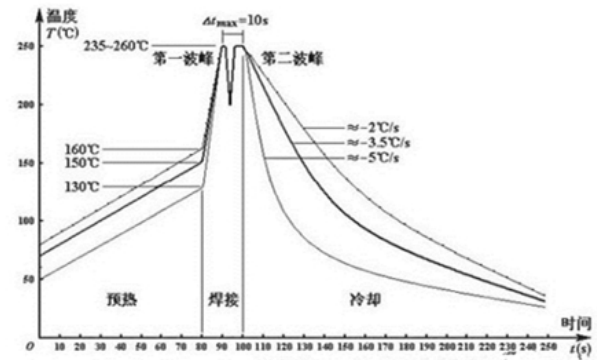
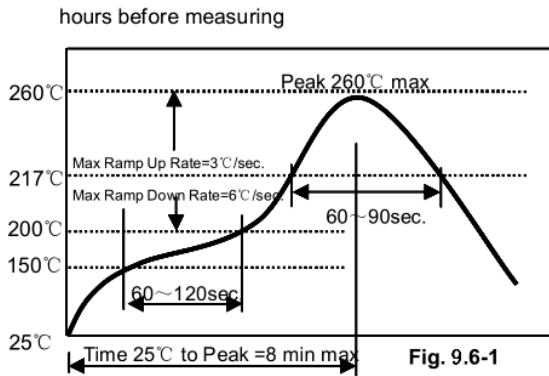

5. Sample Test Data

TEST ITEM	L uH	DCR mΩ	L _{+60A} uH				
CONDITION	100KHz/0.1V	At 25°C	100KHz/0.1V				
SPEC	4.7±20%	2.4mΩ±15%	ΔL/L0≤30%				
1	4.55	2.31	6.8%				
2	4.59	2.29	6.0%				
3	4.55	2.28	7.2%				
4	4.60	2.29	5.5%				
5	4.53	2.27	7.4%				
X							
判定结果	OK	OK	OK				
REMARK:							
APPROVED BY 李庆辉		CHECKED BY 苏高峰		DRAWN BY 劳水花			

Note :	Spec. No. LH2918-047
--------	-------------------------

SPECIFICATIONS

TYPE:
CPQ2918-4R7M

6. Packing specification

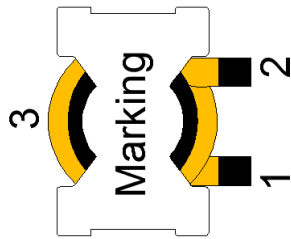

60 个产品装进
吸塑盒

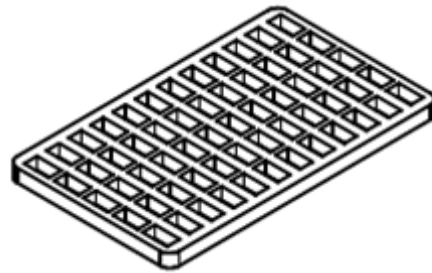
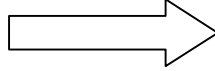

1 盒/扎

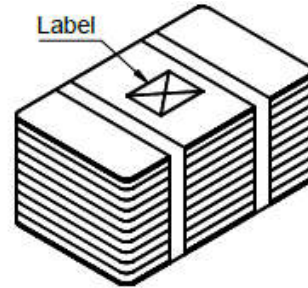
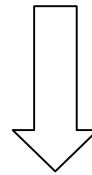

3 扎/箱

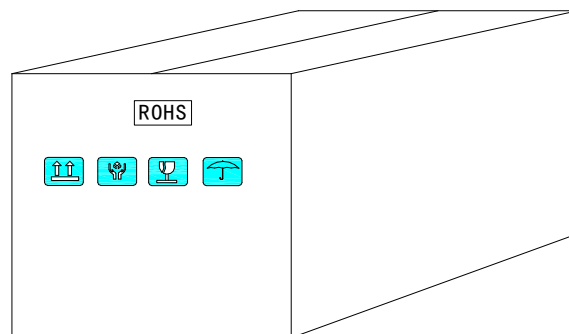

外箱尺寸: 385*285*180mm

包装数量: 60PCS/盒
1 盒/扎, 共 60PCS
3 扎/箱, 共 180PCS

Note :	Spec. No. LH2918-4R7 4/4
--------	--------------------------------