

Specifications

- Current rating:3A AC,DC
- Voltage rating:500V AC,DC
- Temperature range:-40°C~+105°C
- Contact resistance:20mΩMax.
- Insulation resistance:500MΩMin.
- Withstanding voltage:1000V AC/minute
- *Compliant with RoHS and REACH*
- *Meet the HF/Halogen Free,need to customize*
- *Contact CJT for details*

Standards



Assembly layout

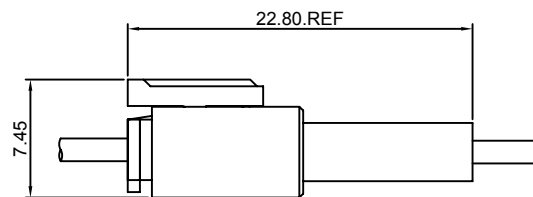

wire to wire

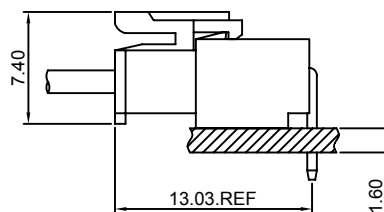
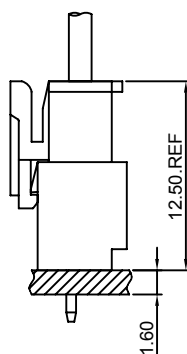

wire to board

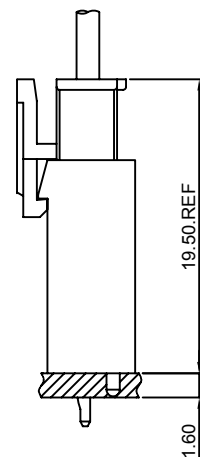

A2512F-T

2.50mm Pitch Crimp Terminal

Reference Informations:

*Used in CJT A2512HF-XP series Housing

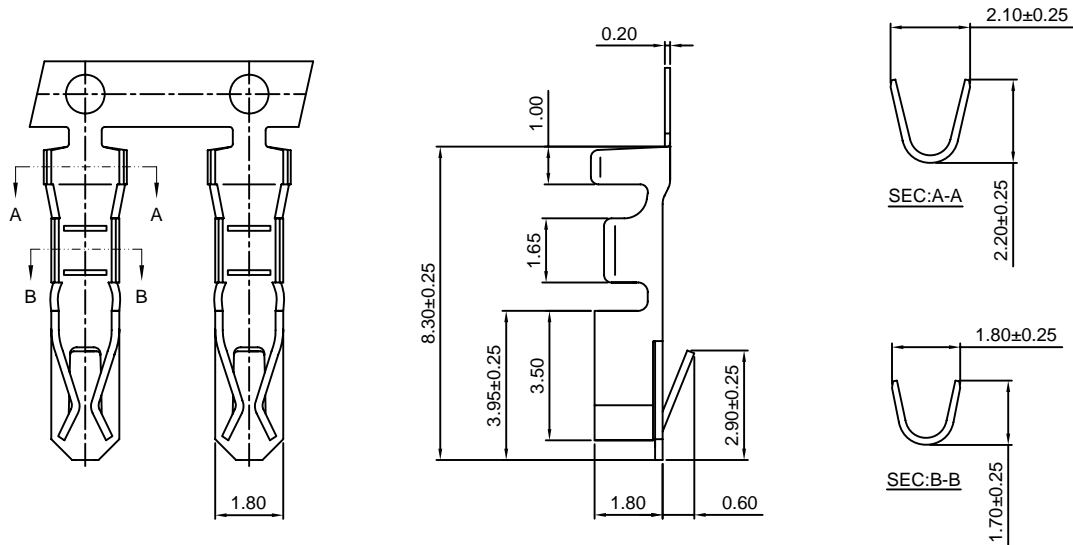

Ordering information & Specifications:

Unit:mm

Part NO.	Wire Range	Insulation O.D.	Material	Finish	Qty/reel
A2512F-TP	AWG#22-#28	1.70mm(max)	Phosphor Bronze	Tin over Nickel	10,000 PCS
A2512F-GP	AWG#22-#28	1.70mm(max)	Phosphor Bronze	Gold over Nickel	10,000 PCS

Optional Gold plating available but MOQ requested

A2512M-T

2.50mm Pitch Crimp Terminal

Reference Informations:

*Used in CJT A2512HM,HMA-XP series Housing

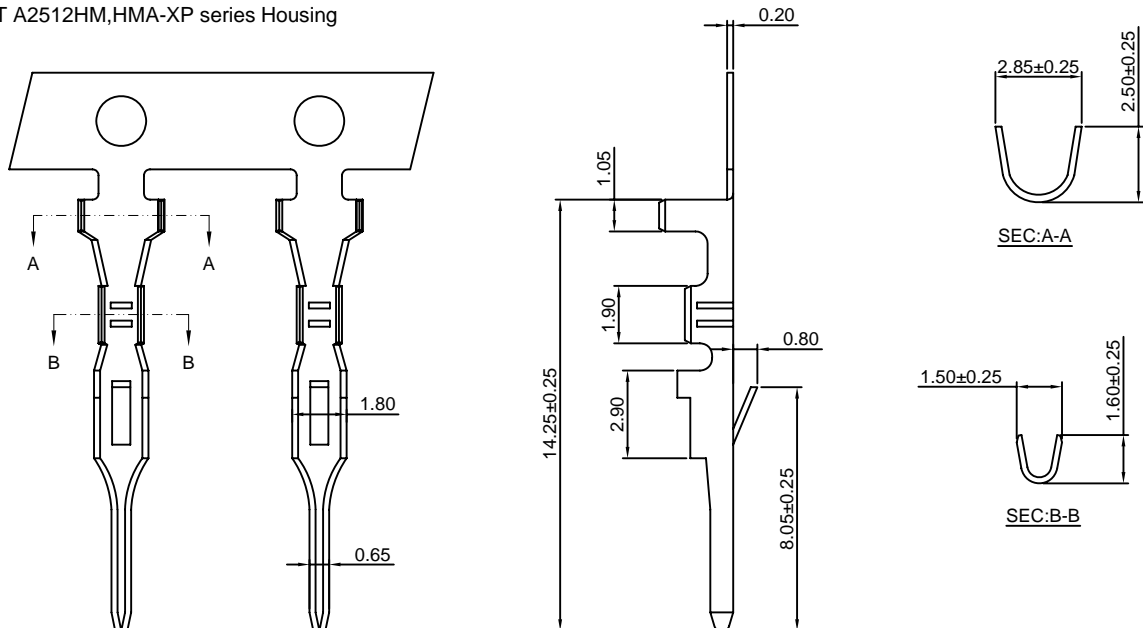

Ordering information & Specifications:

Unit:mm

Part NO.	Wire Range	Insulation O.D.	Material	Finish	Qty/reel
A2512M-TP	AWG#22-#28	1.70mm(max)	Phosphor Bronze	Tin over Nickel	10,000 PCS
A2512M-GP	AWG#22-#28	1.70mm(max)	Phosphor Bronze	Gold over Nickel	10,000 PCS

Optional Gold plating available but MOQ requested

A2512H-XP

2.50mm Pitch Housing

Reference Informations:

- *Material:Nylon 66 , UL94V-0
- *Suitable CJT A2501-T(-A) series Terminal
- *Mates with CJTA2512WV,WR,WV-S,WR-S-XP,A2512WV-F-XP-H, A2512WVA,WRA,WVRA-XP,A2512WVA-F-XP,A2512WVT-XP series Wafer
- *Color:White

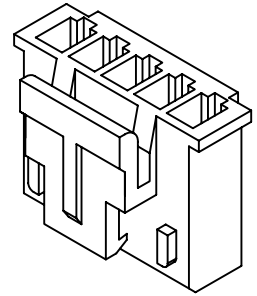
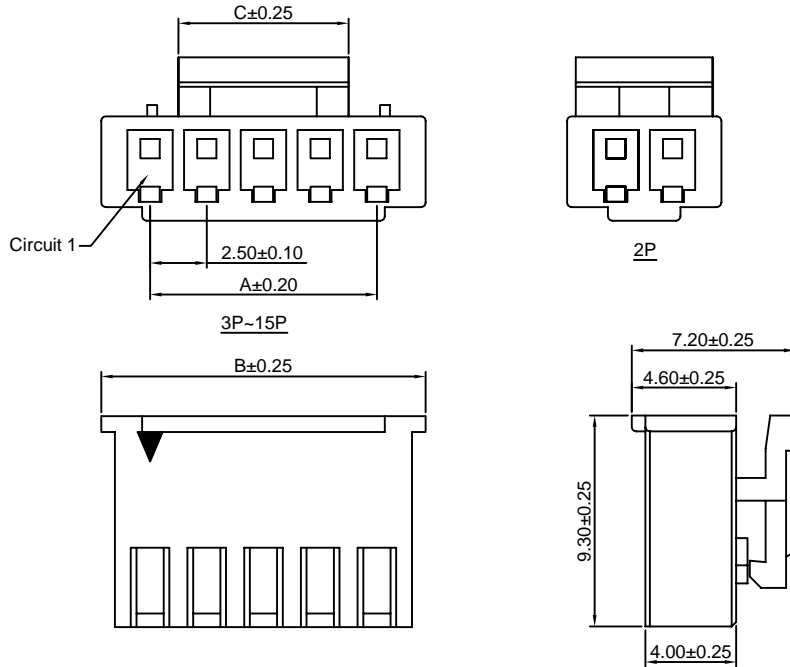

Ordering Information:
A2512H-XP - ***
1 2

- 1.Part No.
- 2.Material:
(Blank):Nylon 66,UL94V-0
GWT :Nylon 66,UL94V-0 GWT 750°C

Ordering Information & Dimensions:

PART NO.	Dimensions		
	A	B	C
2P	2.50	6.80	5.00
3P	5.00	9.30	5.00
4P	7.50	11.80	5.00
5P	10.00	14.30	7.50
6P	12.50	16.80	10.00
7P	15.00	19.30	12.50
8P	17.50	21.80	15.00
9P	20.00	24.30	17.50
10P	22.50	26.80	20.00
11P	25.00	29.30	22.00
12P	27.50	31.80	22.50
13P	30.00	34.30	22.50
14P	32.50	36.80	25.00
15P	35.00	39.30	27.50

Unit: mm

A2512HA-XP

2.50mm Pitch Housing

Reference Informations:

- *Material:Nylon 66 , UL94V-0
- *Suitable CJT A2501-T(-A) series Terminal
- *Mates with CJTA2512WV,WR,WV-S,WR-S-XP,A2512WV-F-XP-H, A2512WVA,WRA,WVRA-XP,A2512WVA-F-XP,A2512WVT-XP series Wafer or A2512SA,SB-XP series Retainer
- *Color:White

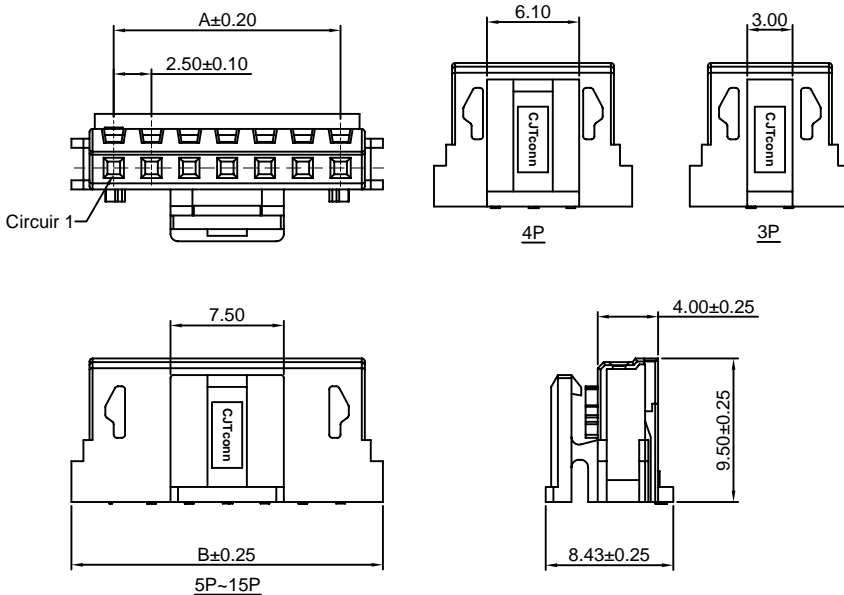

Ordering Information:
A2512HA-XP - *** - **
1 2 3

- 1.Part No.
- 2.Color:
(Blank):White
RD:Red
YL:Yellow
BL:Blue
BK:Black
GN:Green
- 3.Material:
(Blank):Nylon 66,UL94V-0
GWT:Nylon 66,UL94V-0,GWT 750°C

Ordering Information & Dimensions:

PART NO.	Dimensions	
	A	B
3P	5.00	10.60
4P	7.50	13.10
5P	10.00	15.60
6P	12.50	18.10
7P	15.00	20.60
8P	17.50	23.10
9P	20.00	25.60
10P	22.50	28.10
11P	25.00	30.60
12P	27.50	33.10
13P	30.00	35.60
14P	32.50	38.10
15P	35.00	40.60

Unit: mm

A2512HB-XP

2.50mm Pitch Housing

Reference Informations:

- *Material:Nylon 66,UL94V-0
- *Suitable CJT A2501-T(-A) series Terminal
- *Mates with CJTA2512WV,WR,WV-S,WR-S-XP,A2512WV-F-XP-H,A2512WVA,WRA,WVRA-XP,A2512WVA-F-XP,A2512WVT-XP series Wafer or A2512HMA-XP series Housing or A2512SA,SB-XP series Retainer
- *Color:White

Ordering Information:

A2512HB-XP - *** - **
1 2 3

1.Part No.

2.Material:

(Blank):Nylon 66,UL94V-0

GWT:Nylon 66,UL94V-0,GWT 750°C

3.Color:

(Blank):White

RD:Red

YL:Yellow

BL:Blue

BK:Black

GN:Green

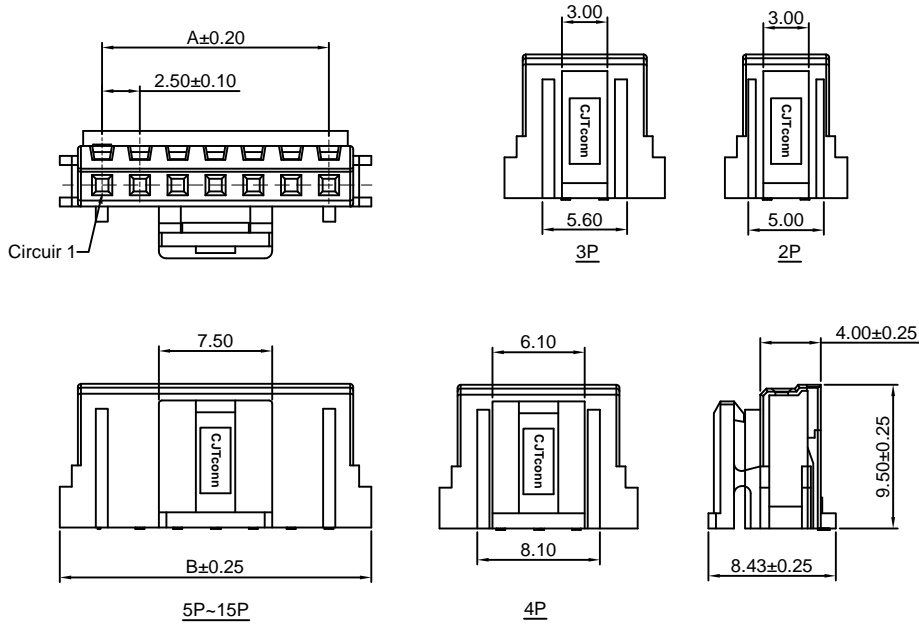

Ordering Information & Dimensions:

PART NO.	Dimensions	
	A	B
2P	2.50	8.10
3P	5.00	10.60
4P	7.50	13.10
5P	10.00	15.60
6P	12.50	18.10
7P	15.00	20.60
8P	17.50	23.10
9P	20.00	25.60
10P	22.50	28.10
11P	25.00	30.60
12P	27.50	33.10
13P	30.00	35.60
14P	32.50	38.10
15P	35.00	40.60

Unit: mm

A2512HF-XP

2.50mm Pitch Housing

Reference Informations:

- *Material:Nylon 66,UL94V-0
- *Suitable CJT A2512F-T series Terminal
- *Mates with CJT A2512HM-XP series Housing
- *Color:White

Ordering Information:

A2512HF-XP - ***
1 2

1.Part No.

2.Material:

(Blank):Nylon 66,UL94V-0

GWT:Nylon 66,UL94V-0,GWT 750°C

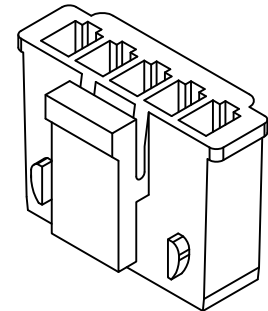
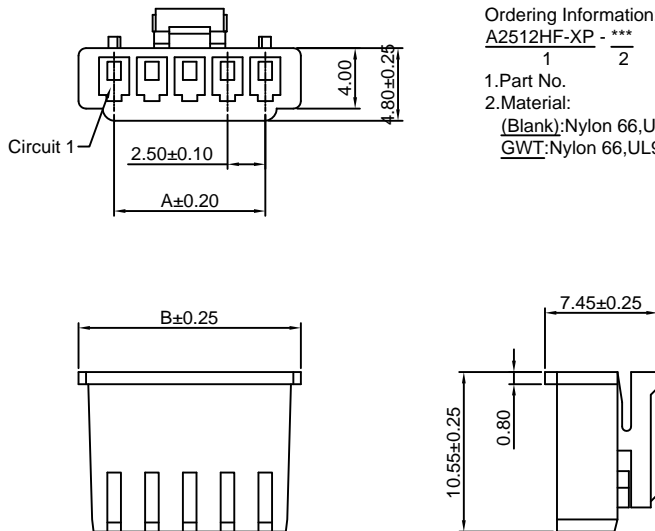

Ordering Information & Dimensions:

PART NO.	Dimensions	
	A	B
2P	2.50	7.20
3P	5.00	9.70
4P	7.50	12.20
5P	10.00	14.70
6P	12.50	17.20
7P	15.00	19.70
8P	17.50	22.20
9P	20.00	24.70
10P	22.50	27.20
11P	25.00	29.70
12P	27.50	32.20
13P	30.00	34.70
14P	32.50	37.20
15P	35.00	39.70

Unit: mm

A2512HM-XP

2.50mm pitch Housing

Reference Informations:

- *Material: Nylon 66 , UL94V-0
- *Suitable CJT A2512M-T series Terminal
- *Mates with CJT A2512HF-XP series Housing
- *Color: White

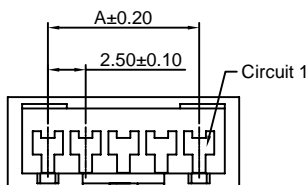

Ordering Information:

A2512HM-XP - ***
1 2

1. Part No.

2. Material:

(Blank): Nylon 66, UL94V-0

GWT : Nylon 66, UL94V-0 GWT 750 °C

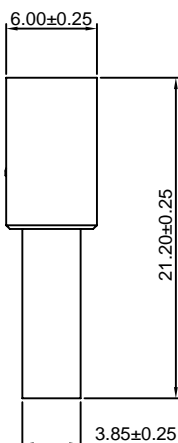
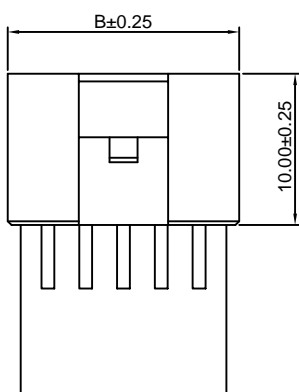
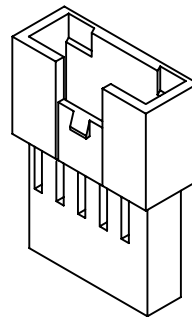

Ordering Information & Dimensions:

PART NO.	Dimensions	
	A	B
2P	2.50	7.88
3P	5.00	10.38
4P	7.50	12.88
5P	10.00	15.38
6P	12.50	17.88
7P	15.00	20.38
8P	17.50	22.88
9P	20.00	25.38
10P	22.50	27.88
11P	25.00	30.38
12P	27.50	32.88
13P	30.00	35.38
14P	32.50	37.88
15P	35.00	40.38

Unit: mm

A2512HMA-XP

2.50mm pitch Housing

Reference Informations:

- *Material: Nylon 66 , UL94V-0
- *Suitable CJT A2512M-T series Terminal
- *Mates with CJT A2512HB-XP series Housing or A2512SA-XP series Retainer
- *Color: White

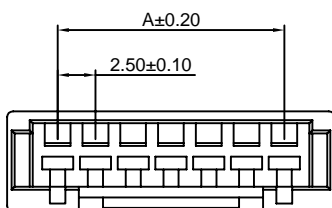

Ordering Information:

A2512HMA-XP - ***
1 2

1. Part No.

2. Material:

(Blank): Nylon 66, UL94V-0

GWT : Nylon 66, UL94V-0 GWT 750 °C

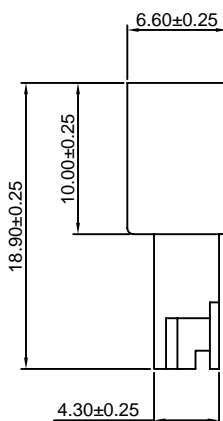
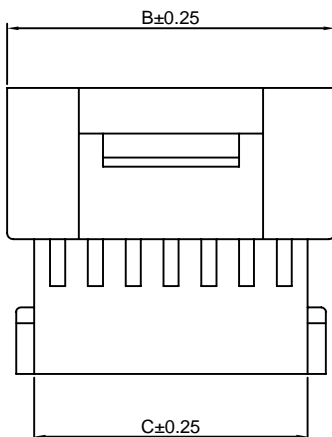

Ordering Information & Dimensions:

PART NO.	Dimensions		
	A	B	C
2P	2.50	9.20	5.60
3P	5.00	11.70	8.10
4P	7.50	14.20	10.60
5P	10.00	16.70	13.10
6P	12.50	19.20	15.60
7P	15.00	21.70	18.10
8P	17.50	24.20	20.60
9P	20.00	26.70	23.10
10P	22.50	29.20	25.60
11P	25.00	31.70	28.10
12P	27.50	34.20	30.60
13P	30.00	36.70	33.10
14P	32.50	39.20	35.60
15P	35.00	41.70	38.10

Unit: mm

A2512SA-XP

2.50mm Pitch Retainer

Reference Informations:

- *Material:Nylon 66 , UL94V-0
- *Mates with CJT A2501HB-XP,A2512HA,HB,HMA-XP series Housing
- *Color:White

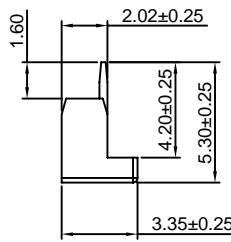
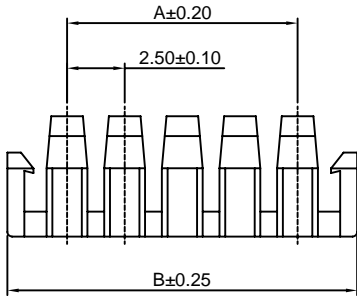
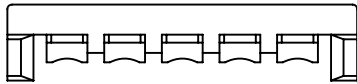

Ordering Information:

A2512SA-XP - ***
1 2

- 1.Part No.
- 2.Material:
(Blank):Nylon 66,UL94V-0
GWT :Nylon 66,UL94V-0,GWT 750 °C

Ordering Information & Dimensions:

PART NO.	Dimensions	
	A	B
2P	2.50	8.00
3P	5.00	10.50
4P	7.50	13.00
5P	10.00	15.50
6P	12.50	18.00
7P	15.00	20.50
8P	17.50	23.00
9P	20.00	25.50
10P	22.50	28.00
11P	25.00	30.50
12P	27.50	33.00
13P	30.00	35.50
14P	32.50	38.00
15P	35.00	40.50

Unit: mm

A2512SB-XP

2.50mm Pitch Retainer

Reference Informations:

- *Material:Nylon 66 , UL94V-0
- *Mates with CJT A2512HA,HB-XP series Housing
- *Color:Red

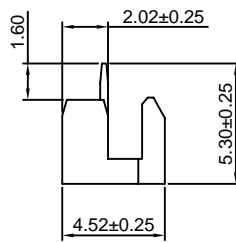
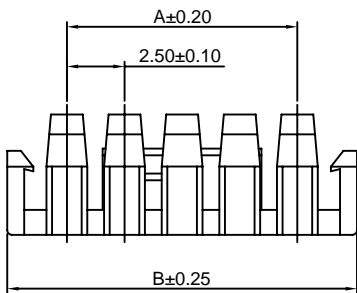
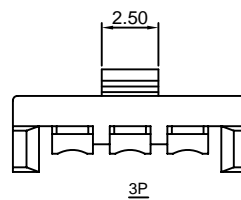
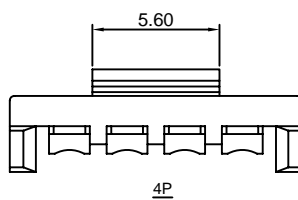
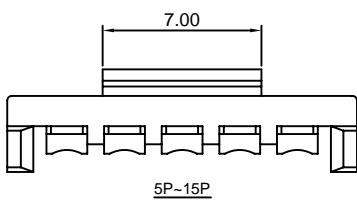

Ordering Information:

A2512SB-XP - ***
1 2

- 1.Part No.
- 2.Material:
(Blank):Nylon 66,UL94V-0
GWT :Nylon 66,UL94V-0,GWT 750 °C

Ordering Information & Dimensions:

PART NO.	Dimensions	
	A	B
3P	5.00	10.50
4P	7.50	13.00
5P	10.00	15.50
6P	12.50	18.00
7P	15.00	20.50
8P	17.50	23.00
9P	20.00	25.50
10P	22.50	28.00
11P	25.00	30.50
12P	27.50	33.00
13P	30.00	35.50
14P	32.50	38.00
15P	35.00	40.50

Unit: mm

A2512WV-XP

2.50mm pitch 180° Wafer

Reference Informations:

- *Material:Pin:Brass/Tin over Nickel
Insulator:Nylon 66,UL94V-0
- *Mates with CJT A2512H,HA,HB-XP series Housing
- *Color:White

Ordering Information:
A2512WV-XP - *** - **
1 2 3

- 1.Part No.
- 2.Material:
(Blank):Nylon 66,UL94V-0
GWT:Nylon 66,UL94V-0,GWT 750 °C
- 3.Finish:
(blank):Tin over Nickel
G:Gold over Nickel

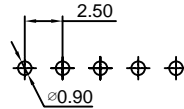
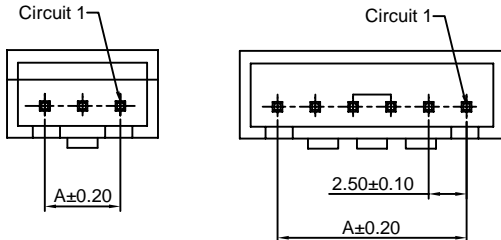
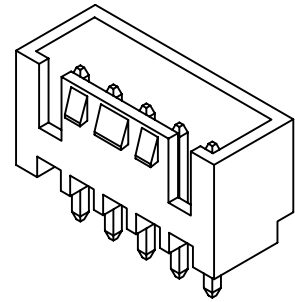

P.C.B LAYOUT

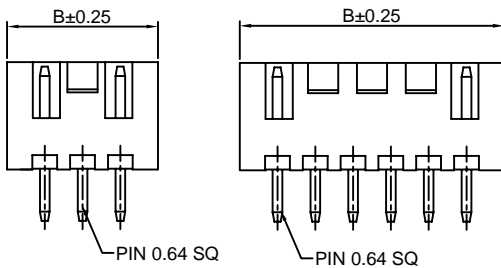

2P~4P

5P~15P

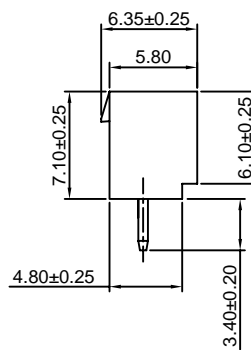

Ordering Information & Dimensions:

PART NO.	Dimensions	
	A	B
2P	2.50	7.50
3P	5.00	10.00
4P	7.50	12.50
5P	10.00	15.00
6P	12.50	17.50
7P	15.00	20.00
8P	17.50	22.50
9P	20.00	25.00
10P	22.50	27.50
11P	25.00	30.00
12P	27.50	32.50
13P	30.00	35.00
14P	32.50	37.50
15P	35.00	40.00

Unit: mm

A2512WR-XP

2.50mm pitch 90° Wafer

Reference Informations:

- *Material:Pin:Brass/Tin over Nickel
Insulator:Nylon 66,UL94V-0
- *Mates with CJT A2512H,HA,HB-XP series Housing
- *Color:White

Ordering Information:
A2512WR-XP - *** - **
1 2 3

- 1.Part No.
- 2.Material:
(Blank):Nylon 66,UL94V-0
GWT:Nylon 66,UL94V-0,GWT 750 °C
- 3.Finish:
(blank):Tin over Nickel
G:Gold over Nickel

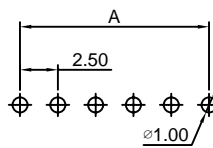
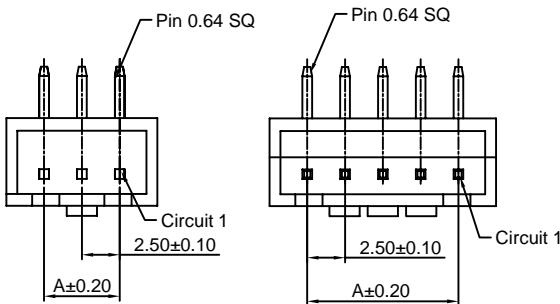
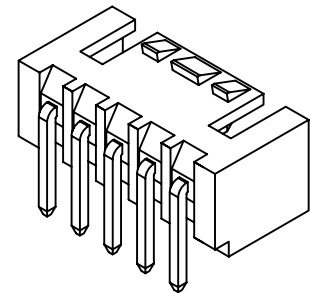

P.C.B LAYOUT

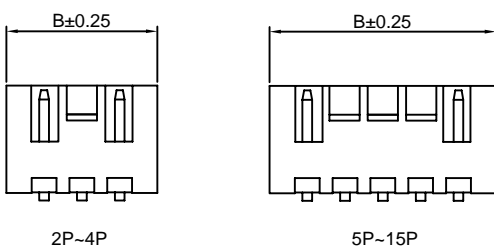

2P~4P

5P~15P

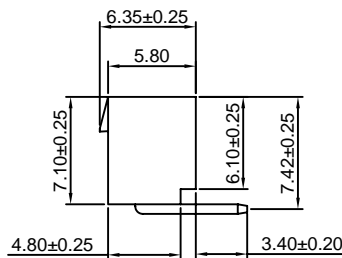

Ordering Information & Dimensions:

PART NO.	Dimensions	
	A	B
2P	2.50	7.50
3P	5.00	10.00
4P	7.50	12.50
5P	10.00	15.00
6P	12.50	17.50
7P	15.00	20.00
8P	17.50	22.50
9P	20.00	25.00
10P	22.50	27.50
11P	25.00	30.00
12P	27.50	32.50
13P	30.00	35.00
14P	32.50	37.50
15P	35.00	40.00

Unit: mm

A2512WV-S-XP

2.50mm pitch 180° Wafer-SMT TYPE

Reference Informations:

- *Material: Pin: Phosphor bronze/Tin over Nickel
Insulator: LCP, UL94V-0
- *Mates with CJT A2512H, HA, HB-XP series Housing
- *Color: Ivory

Ordering Information:

A2512WV-S-XP - *** - **
1 2 3

1. Part No.
2. Material:
(Blank): LCP, UL94V-0
GWT: LCP, UL94V-0, GWT 750 °C
3. Finish:
(blank): Tin over Nickel
G: Gold over Nickel

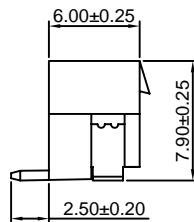
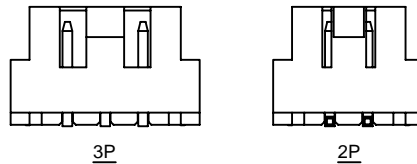
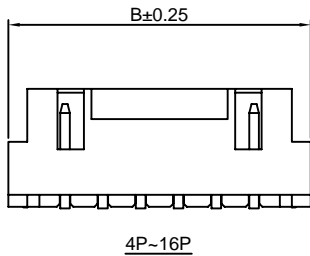
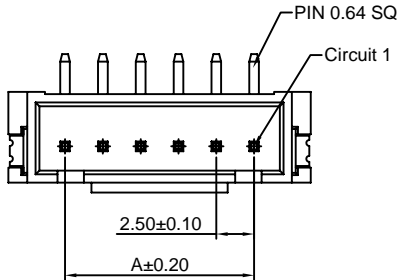
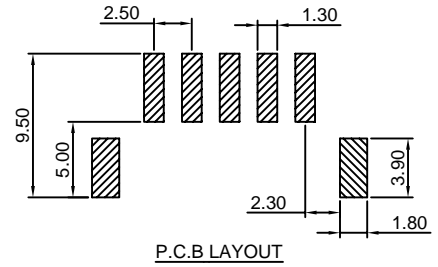

Ordering Information & Dimensions:

PART NO.	Dimensions	
	A	B
2P	2.50	10.00
3P	5.00	12.50
4P	7.50	15.00
5P	10.00	17.50
6P	12.50	20.00
7P	15.00	22.50
8P	17.50	25.00
9P	20.00	27.50
10P	22.50	30.00
11P	25.00	32.50
12P	27.50	35.00
13P	30.00	37.50
14P	32.50	40.00
15P	35.00	42.50
16P	37.50	45.00

Unit: mm

A2512WR-S-XP

2.50mm pitch 90° Wafer-SMT TYPE

Reference Informations:

- *Material: Pin: Phosphor bronze/Tin over Nickel
Insulator: LCP, UL94V-0
- *Mates with CJT A2512H, HA, HB-XP series Housing
- *Color: Ivory

Ordering Information:

A2512WR-S-XP - *** - **
1 2 3

1. Part No.
2. Material:
(Blank): LCP, UL94V-0
GWT: LCP, UL94V-0, GWT 750 °C
3. Finish:
(blank): Tin over Nickel
G: Gold over Nickel

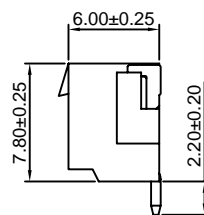
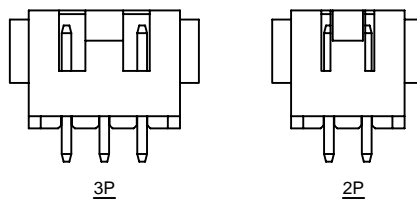
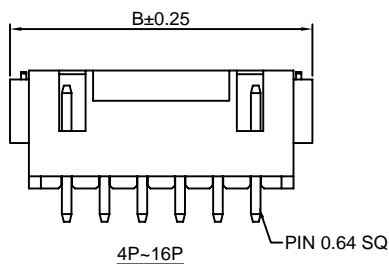
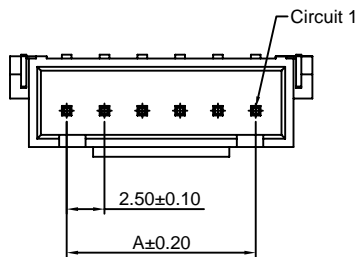
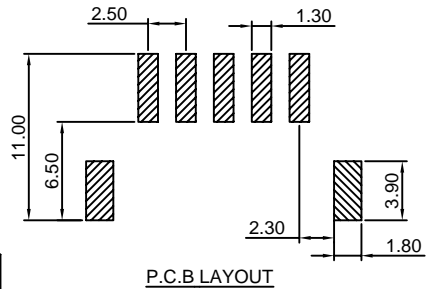

Ordering Information & Dimensions:

PART NO.	Dimensions	
	A	B
2P	2.50	10.00
3P	5.00	12.50
4P	7.50	15.00
5P	10.00	17.50
6P	12.50	20.00
7P	15.00	22.50
8P	17.50	25.00
9P	20.00	27.50
10P	22.50	30.00
11P	25.00	32.50
12P	27.50	35.00
13P	30.00	37.50
14P	32.50	40.00
15P	35.00	42.50
16P	37.50	45.00

Unit: mm

A2512WV-F-XP-H

2.50mm pitch 180° Wafer-High box type

Reference Informations:

- *Material: Pin: Brass/Tin over Nickel
Insulator: Nylon 66, UL94V-0
- *Mates with CJT A2512H, HA, HB-XP series Housing
- *Color: White

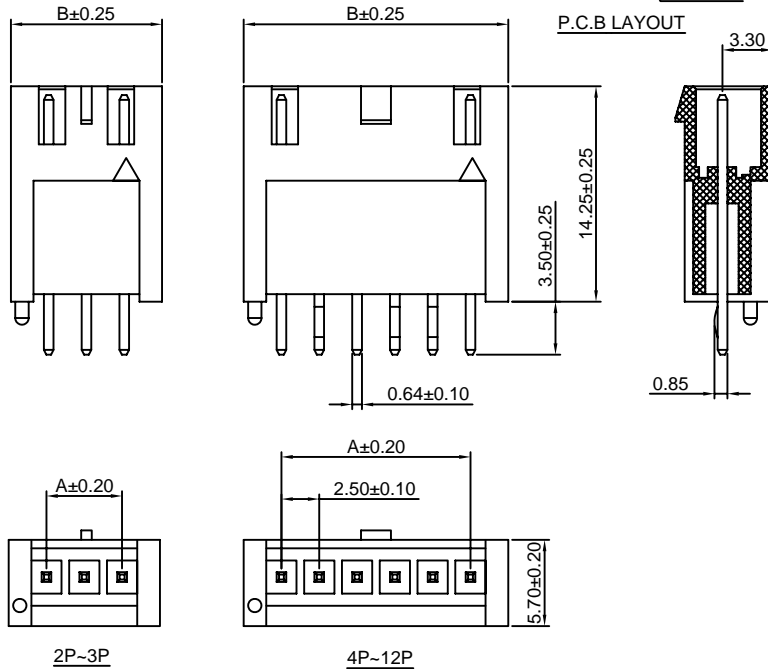
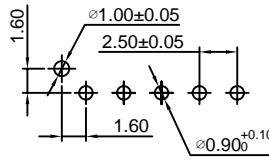

Ordering Information:

A2512WV-F-XP-H - ^{***}/₂ - ^{**}/₃ - ^{**}/₄

- Part No.
- Material:
(Blank): Nylon 66, UL94V-0
GWT: Nylon 66, UL94V-0, GWT 750 °C
- Color:
(blank): White
BL: Blue
BK: Black
RD: Red
YL: Yellow
GN: Green
- Finish:
(blank): Tin over Nickel
G: Gold over Nickel

Ordering Information & Dimensions:

PART NO.	Dimensions	
	A	B
2P	2.50	7.50
3P	5.00	10.00
4P	7.50	12.50
5P	10.00	15.00
6P	12.50	17.50
7P	15.00	20.00
8P	17.50	22.50
9P	20.00	25.00
10P	22.50	27.50
11P	25.00	30.00
12P	27.50	32.50

Unit: mm

A2512WVA-XP

2.50mm pitch 180° Wafer

Reference Informations:

- *Material: Pin: Brass/Tin over Nickel
Insulator: Nylon 66, UL94V-0
- *Mates with CJT A2512H, HA, HB-XP, A2501H-XP series Housing
- *Color: White

Ordering Information:

A2512WVA-XP - ^{*}/₂ - ^{***}/₃ - ^{**}/₄ - ^{**}/₅

- Part No
- Style:
(blank) : Type 1
2 : Type 2
- Material:
(Blank): Nylon 66, UL94V-0
GWT: Nylon 66, UL94V-0, GWT 750 °C
- Color:
(blank): White
BL: Blue
BK: Black
RD: Red
YL: Yellow
GN: Green
- Finish:
(blank): Tin over Nickel
G: Gold over Nickel

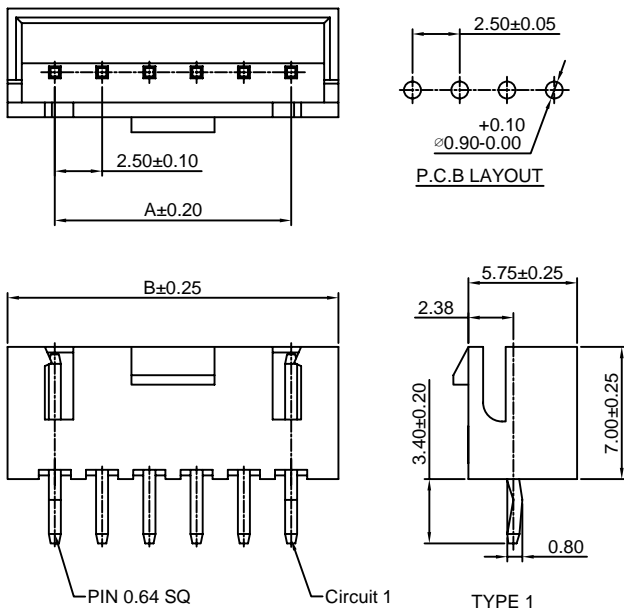
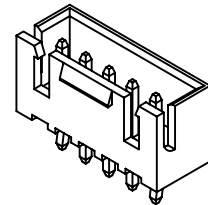

Ordering Information & Dimensions:

PART NO.	Dimensions	
	A	B
3P	5.00	10.00
4P	7.50	12.50
5P	10.00	15.00
6P	12.50	17.50
7P	15.00	20.00
8P	17.50	22.50
9P	20.00	25.00
10P	22.50	27.50
11P	25.00	30.00
12P	27.50	32.50
13P	30.00	35.00
14P	32.50	37.50
15P	35.00	40.00
16P	37.50	42.50
17P	40.00	45.00
18P	42.50	47.50
19P	45.00	50.00
20P	47.50	52.50

Unit: mm

A2512WRA-XP

2.50mm pitch 90° Wafer

Reference Informations:

*Material:Pin:Brass/Tin over Nickel
Insulator:Nylon 66,UL94V-0

*Mates with CJT A2512H,HA,HB-XP,A2501H-XP series Housing

*Color:White

Ordering Information:

A2512WRA-XP - * - *** - ** - **
1 2 3 4 5

- Part No
- Style:
(blank) :Type 1
2 :Type 2
- Material:
(Blank):Nylon 66,UL94V-0
GWT:Nylon 66,UL94V-0,GWT 750 °C
- Color:
(blank):White
BL:Blue
BK:Black
RD:Red
YL:Yellow
GN:Green
- Finish:
(blank):Tin over Nickel
G:Gold over Nickel

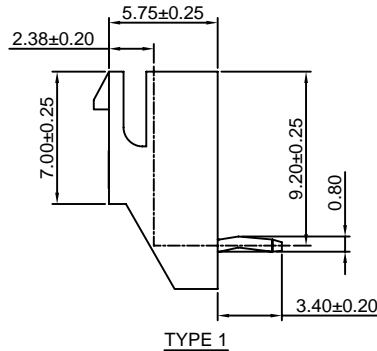
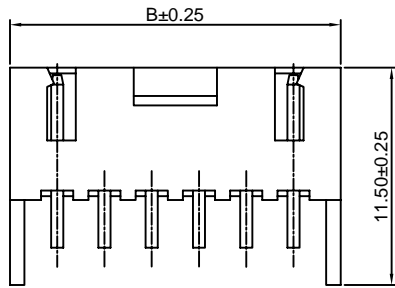
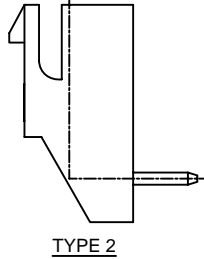
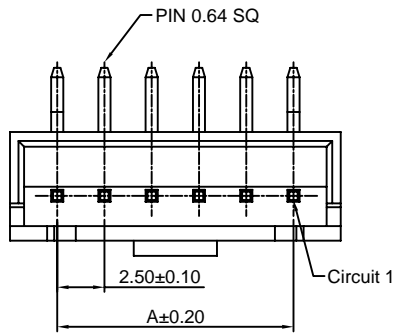
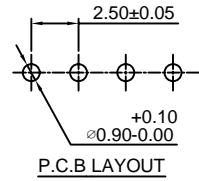

Ordering Information & Dimensions:

PART NO.	Dimensions	
	A	B
3P	5.00	10.00
4P	7.50	12.50
5P	10.00	15.00
6P	12.50	17.50
7P	15.00	20.00
8P	17.50	22.50
9P	20.00	25.00
10P	22.50	27.50
11P	25.00	30.00
12P	27.50	32.50
13P	30.00	35.00
14P	32.50	37.50
15P	35.00	40.00
16P	37.50	42.50
17P	40.00	45.00
18P	42.50	47.50
19P	45.00	50.00
20P	47.50	52.50

Unit: mm

A2512WVA-F-XP

2.50mm pitch 180° Wafer - With Boss

Reference Informations:

*Material:Pin:Brass/Tin over Nickel
Insulator:Nylon 66,UL94V-0

*Mates with CJT A2512H,HA,HB-XP,A2501H-XP series Housing

*Color:White

Ordering Information:

A2512WVA-F-XP - *** - ** - **
1 2 3 4

- Part No
- Material:
(Blank):Nylon 66,UL94V-0
GWT:Nylon 66,UL94V-0,GWT 750 °C
- Color:
(blank):White
BL:Blue
BK:Black
RD:Red
YL:Yellow
GN:Green
- Finish:
(blank):Tin over Nickel
G:Gold over Nickel

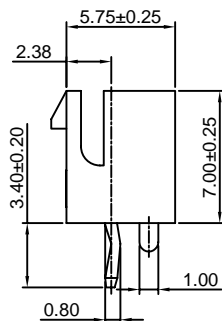
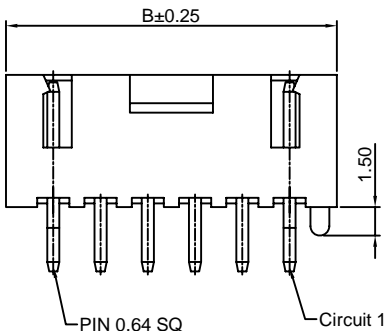
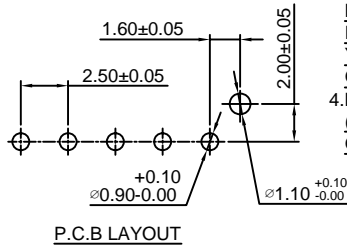
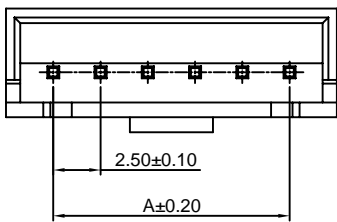
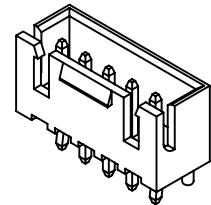

Ordering Information & Dimensions:

PART NO.	Dimensions	
	A	B
3P	5.00	10.00
4P	7.50	12.50
5P	10.00	15.00
6P	12.50	17.50
7P	15.00	20.00
8P	17.50	22.50
9P	20.00	25.00
10P	22.50	27.50
11P	25.00	30.00
12P	27.50	32.50
13P	30.00	35.00
14P	32.50	37.50
15P	35.00	40.00
16P	37.50	42.50
17P	40.00	45.00
18P	42.50	47.50
19P	45.00	50.00
20P	47.50	52.50

Unit: mm

A2512WVRA-XP

2.50mm pitch 90° Wafer

Reference Informations:

- *Material: Pin: Brass/Tin over Nickel
Insulator: Nylon 66, UL94V-0
- *Mates with CJT A2512H, HA, HB-XP, A2501H-XP series Housing
- *Color: White

Ordering Information:

A2512WVRA-XP - * - *** - ** - **
1 2 3 4 5

1. Part No
2. Style:
(blank) : Type 1
2 : Type 2
3. Material:
(Blank): Nylon 66, UL94V-0
GWT: Nylon 66, UL94V-0, GWT 750 °C
4. Color:
(blank): White
BL: Blue
BK: Black
RD: Red
YL: Yellow
GN: Green
5. Finish:
(blank): Tin over Nickel
G: Gold over Nickel

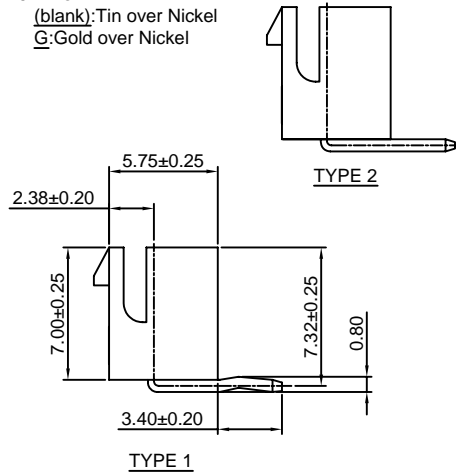
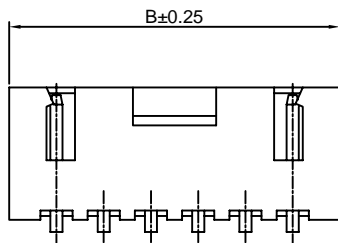
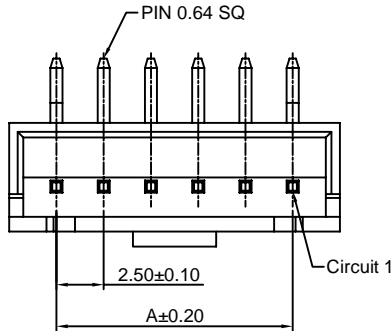
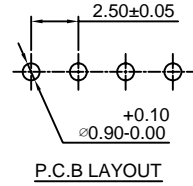

Ordering Information & Dimensions:

PART NO.	Dimensions	
	A	B
3P	5.00	10.00
4P	7.50	12.50
5P	10.00	15.00
6P	12.50	17.50
7P	15.00	20.00
8P	17.50	22.50
9P	20.00	25.00
10P	22.50	27.50
11P	25.00	30.00
12P	27.50	32.50
13P	30.00	35.00
14P	32.50	37.50
15P	35.00	40.00
16P	37.50	42.50
17P	40.00	45.00
18P	42.50	47.50
19P	45.00	50.00
20P	47.50	52.50

Unit: mm

A2512WVT-XP

2.50mm pitch 180° Wafer ON RADIAL-TAPE

Reference Informations:

- *Material: Pin: Brass/Tin over Nickel
Insulator: Nylon 66, UL94V-0
- *Mates with CJT A2512H, HA, HB-XP, A2501H-XP series Housing
- *Color: White

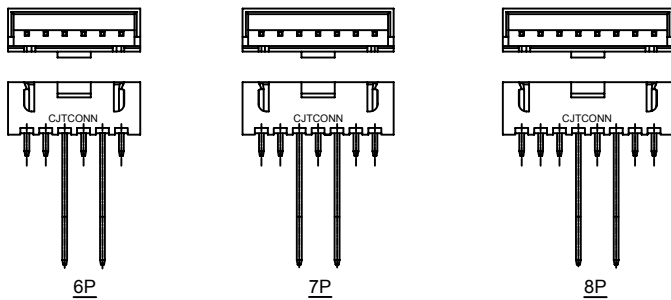
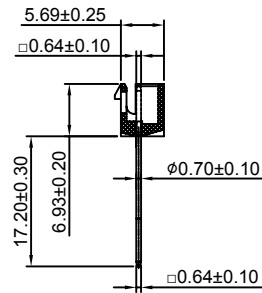
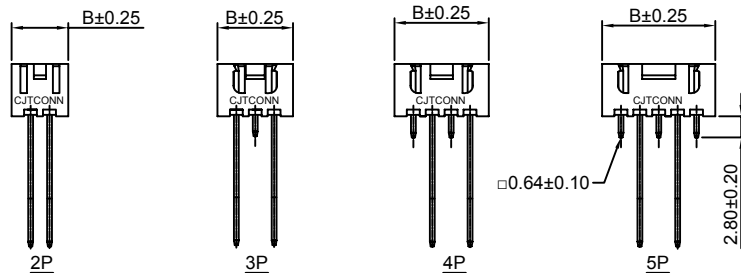
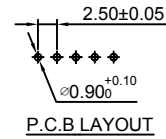
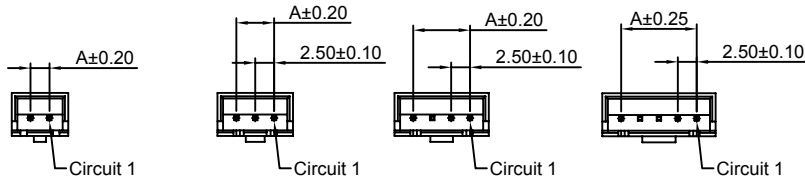
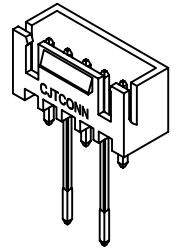

Ordering Information:

A2512WVT-XP - *** - ** - **

- Part No.
- Material:
(Blank): Nylon 66, UL94V-0
GWT: Nylon 66, UL94V-0, GWT 750 °C
- Color:
(blank): White BK: Black
RD: Red YL: Yellow
BL: Blue GN: Green
- Finish:
(blank): Tin over Nickel
G: Gold over Nickel

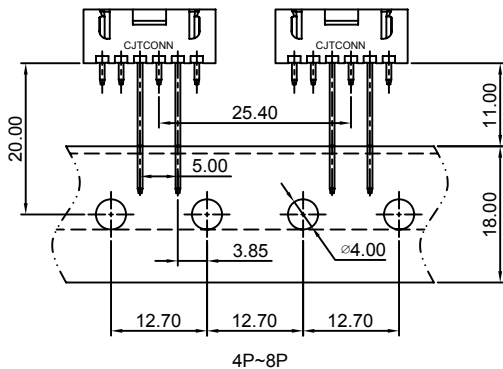
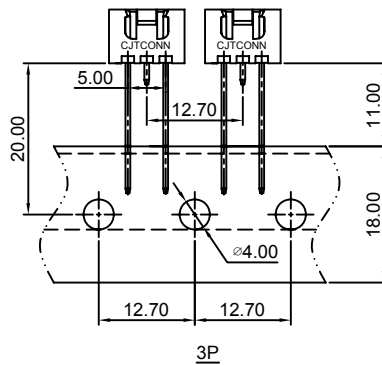
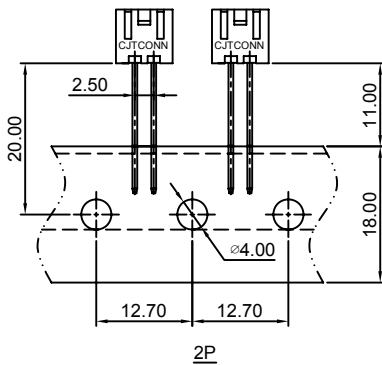

Ordering Information & Dimensions:

PART NO.	Dimensions	
	A	B
2P	2.50	7.50
3P	5.00	10.00
4P	7.50	12.50
5P	10.00	15.00
6P	12.50	17.50
7P	15.00	20.00
8P	17.50	22.50

Unit: mm