

SURFACE MOUNT SCHOTTKY BARRIER RECTIFIER

Features

- ◆ Trench MOS Schottky barrier diodes
- ◆ Low forward voltage drop
- ◆ low profile - typical body height 1.1 mm
- ◆ Moisture sensitivity: level 1, per J-STD-020
- ◆ High temperature soldering guaranteed:
260 °C/10 seconds - RoHS Compliant
- ◆ Halogen-free according to IEC 61249-2-21 definition

TO-277

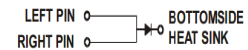
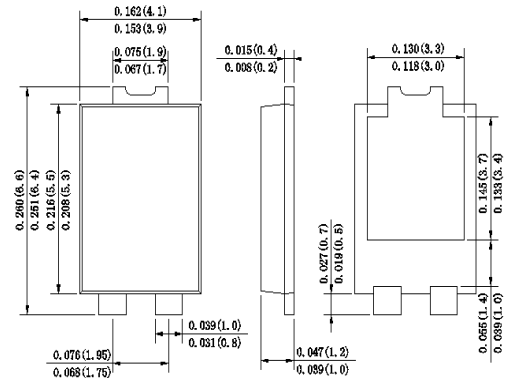

Dimensions in inches and (millimeters)

Mechanical Data

Case : JEDEC TO-277 Molded plastic body
Case Material: Molding compound meets UL 94V-0 flammability rating

Terminals :Plated Leads Solderable per MIL-STD-202,Method 208

Polarity : Polarity symbol marking on body

Mounting Position : Any

Weight : 0.003 ounce, 0.092 grams

Maximum Ratings And Electrical Characteristics

Ratings at 25°C ambient temperature unless otherwise specified.

Single phase half-wave 60Hz, resistive or inductive load, for capacitive load current derate by 20%.

Parameter	SYMBOL	ST2045		UNIT
		MDD	ST2045	
Marking Code				
Maximum repetitive peak reverse voltage	V_{RRM}	45		V
Maximum DC blocking voltage	V_{DC}	32		V
RMS Reverse voltage	V_{RMS}	20		A
Average Rectified Output Current	$I_{(O)}$	400		A
Non-Repetitive Peak Forward Surge 8.3ms Single Half Sine-Wave Superimposed on rated load(JEDEC Method)	I_{FSM}			

Electrical Characteristics $T_a=25^\circ\text{C}$ unless otherwise noted

Parameter	Test Conditions	Symbol	Value		Unit
			Typ	Max	
Forward Voltage Drop at 20A	$T_A=25^\circ\text{C}$	V_F	0.47	0.50	V
	$T_A=125^\circ\text{C}$		0.42	0.45	
Peak reverse current at rated DC blocking voltage	$T_A=25^\circ\text{C}$	I_R	35	60	uA
	$T_A=125^\circ\text{C}$		40	70	
Operating junction storage temperature range		T_J	-55 to +150		°C
Storage temperature range		T_{STG}	-55 to +150		°C
Typical thermal resistance Junction to Ambient		$R_{\theta JC}$	1		°C/W

Note: 1. The typical data above is for reference only.

Ratings And Characteristic Curves

FIG.1: Forward Output Current Derating Curve

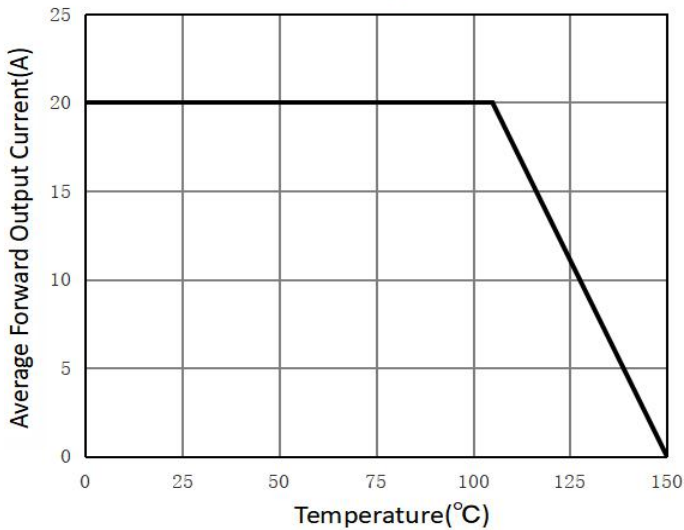

FIG.2: Maximum Non-Repetitive Peak Forward Surge Current

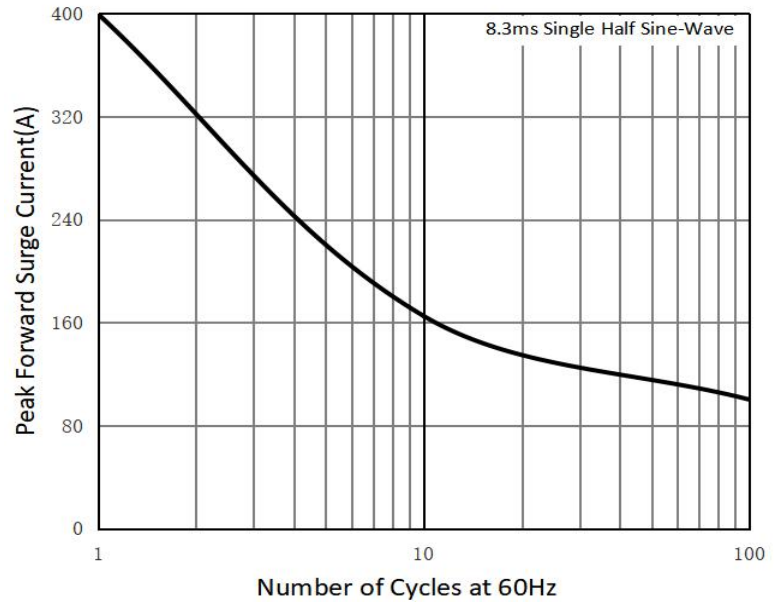

FIG.3: Typical Instantaneous Forward Characteristics

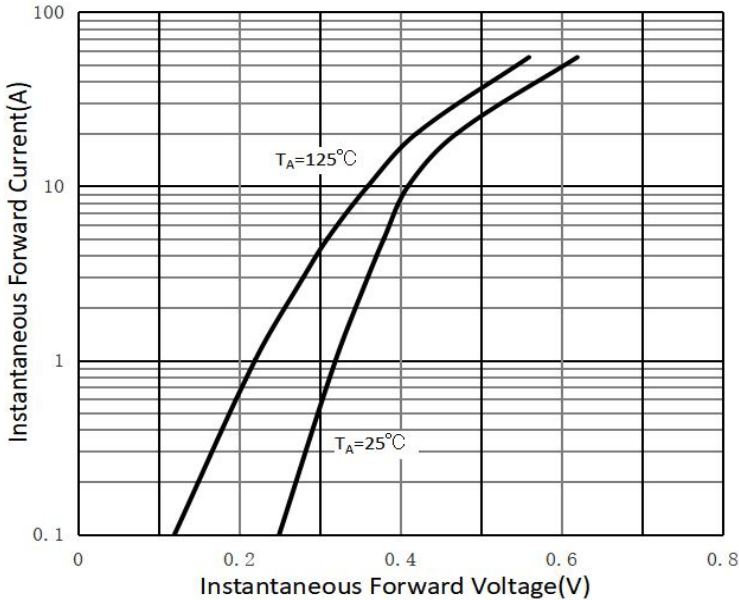
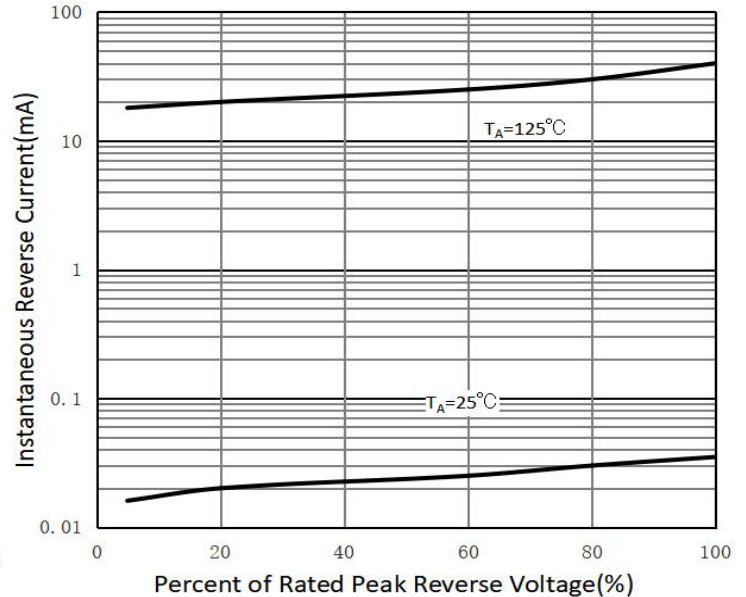
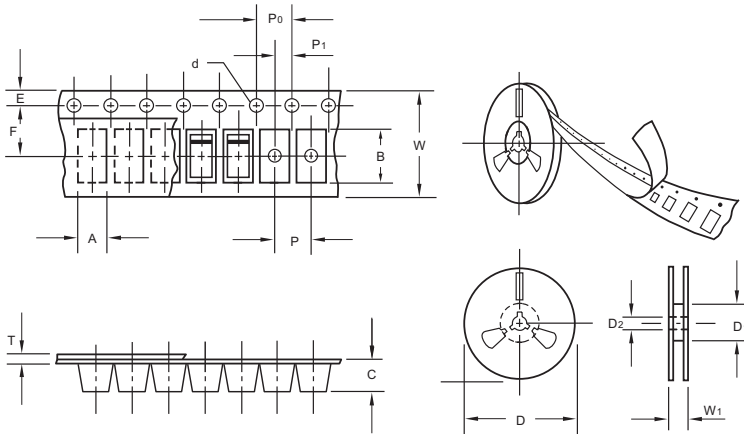

FIG.4: Typical Reverse Characteristics



The curve above is for reference only.

Packing information



unit:mm

Item	Symbol	Tolerance	TO-277
Carrier width	A	0.1	4.45
Carrier length	B	0.1	7.0
Carrier depth	C	0.1	1.60
Sprocket hole	d	0.05	1.55
13" Reel outside diameter	D	2.0	330.00
13" Reel inner diameter	D ₁	min	50.0
Feed hole diameter	D ₂	0.5	13.00
Sprocket hole position	E	0.1	1.75
Punch hole position	F	0.1	7.50
Punch hole pitch	P	0.1	8.00
Sprocket hole pitch	P ₀	0.1	4.00
Embossment center	P ₁	0.1	2.00
Overall tape thickness	T	0.1	0.25
Tape width	W	0.3	12.00
Reel width	W ₁	1.0	12.30

Note: Devices are packed in accordance with EIA standard RS-481-A and specifications listed above.

Reel packing

PACKAGE	REEL SIZE	REEL (pcs)	COMPONENT SPACING (m/m)	BOX (pcs)	INNER BOX (m/m)	REEL DIA, (m/m)	CARTON SIZE (m/m)	CARTON (pcs)	APPROX. GROSS WEIGHT (kg)
TO-277	13"	5,000	4.0	10,000	210*208*203	330	430*430*235	80,000	13.0

Suggested Pad Layout

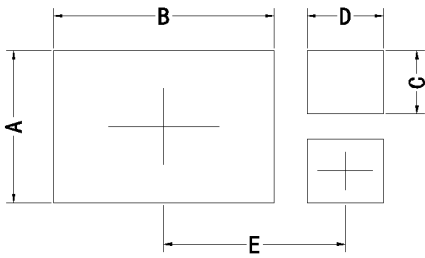

Symbol	Unit (mm)	Unit (inch)
A	3.60	0.142
B	5.35	0.211
C	1.50	0.059
D	1.85	0.073
E	4.30	0.169