

SURFACE MOUNT SCHOTTKY BARRIER RECTIFIER

Features

- ◆ The plastic package carries Underwriters Laboratory Flammability Classification 94V-0
- ◆ For surface mounted applications
- ◆ Metal silicon junction, majority carrier conduction
- ◆ Low power loss, high efficiency
- ◆ Built-in strain relief, ideal for automated placement
- ◆ High forward surge current capability
- ◆ High temperature soldering guaranteed:
250 °C/10 seconds at terminals

DO-214AA/SMB

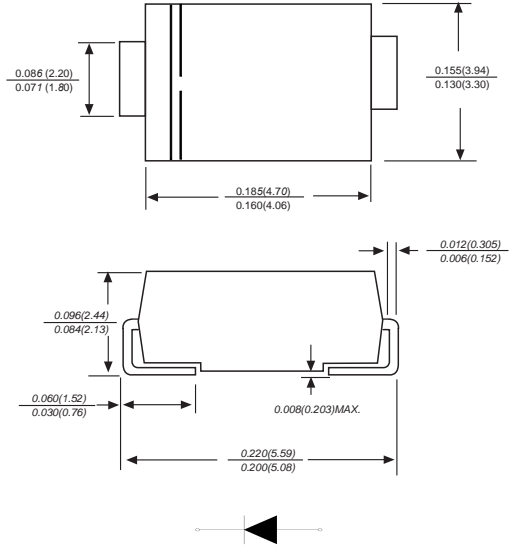

Dimensions in inches and (millimeters)

Mechanical Data

Case: JEDEC DO-214AA/SMB molded plastic body
 Terminals: Solderable per MIL-STD-750, Method 2026
 Polarity: Color band denotes cathode end Mounting
 Position: Any
 Weight: 0.003 ounce, 0.095 grams

Maximum Ratings And Electrical Characteristics

Ratings at 25°C ambient temperature unless otherwise specified.

Single phase half-wave 60Hz, resistive or inductive load, for capacitive load current derate by 20%.

| Parameter | SYMBOLS | SS52B | SS53B | SS54B | SS55B | SS56B | SS58B | SS510B | SS5150B | SS5200B | UNITS |
|---|-----------------|--------------|--------------|--------------|--------------|--------------|--------------|---------------|----------------|----------------|-------|
| | | MDD SS52B | MDD SS53B | MDD SS54B | MDD SS55B | MDD SS56B | MDD SS58B | MDD SS510B | MDD SS5150B | MDD SS5200B | |
| Maximum repetitive peak reverse voltage | V_{RRM} | 20 | 30 | 40 | 50 | 60 | 80 | 100 | 150 | 200 | V |
| Maximum RMS voltage | V_{RMS} | 14 | 21 | 28 | 35 | 42 | 56 | 70 | 105 | 140 | V |
| Maximum DC blocking voltage | V_{DC} | 20 | 30 | 40 | 50 | 60 | 80 | 100 | 150 | 200 | V |
| Maximum average forward rectified current at TL (see fig.1) | I_{AV} | 5.0 | | | | | | | | | A |
| Peak forward surge current 8.3ms single half sine-wave superimposed on rated load (JEDEC Method) | I_{FSM} | 150 | | | | | | | | | A |
| Maximum instantaneous forward voltage at 5.0A | V_F | 0.55 | | 0.70 | | | 0.85 | | | | V |
| Maximum DC reverse current $T_A=25^\circ\text{C}$ at rated DC blocking voltage $T_A=125^\circ\text{C}$ | I_R | 1.0 | | | | | 0.3 | | | | mA |
| | | 50 | | | | | 25 | | | | |
| Typical junction capacitance (NOTE 1) | C_J | 500 | | | | | 300 | | | | pF |
| Typical thermal resistance (NOTE 2) | $R_{\theta JA}$ | 50.0 | | | | | | | | | °C/W |
| Operating junction temperature range | T_J | -50 to +150 | | | | | | | | | °C |
| Storage temperature range | T_{STG} | -50 to +150 | | | | | | | | | °C |

Note: 1. Measured at 1MHz and applied reverse voltage of 4.0V D.C.
 2. P.C.B. mounted with 0.2x0.2" (5.0x5.0mm) copper pad areas

Typical Characteristics

Fig.1 Forward Current Derating Curve

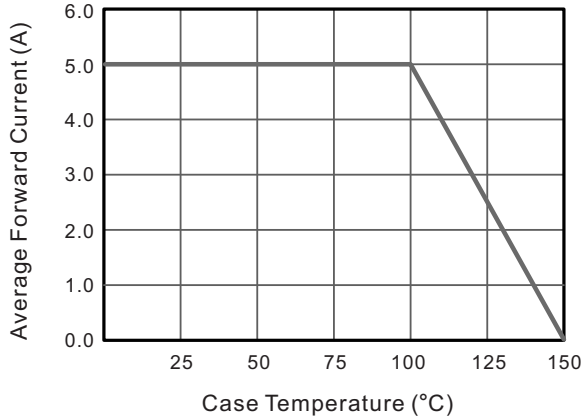

Fig.2 Typical Reverse Characteristics

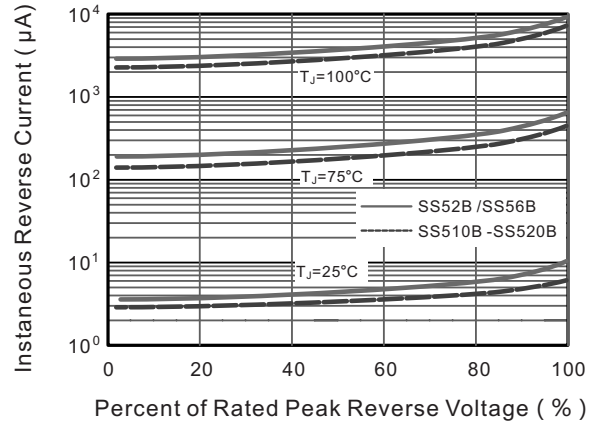

Fig.3 Typical Forward Characteristic

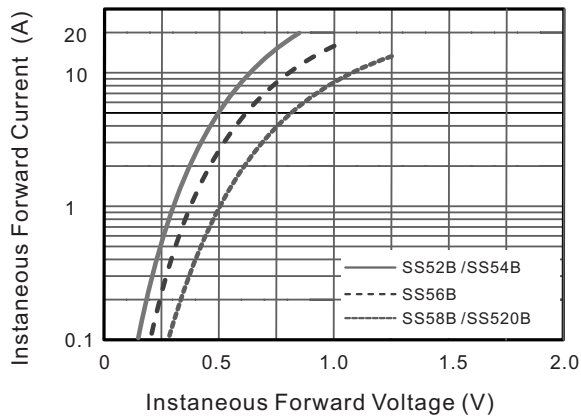

Fig.4 Typical Junction Capacitance

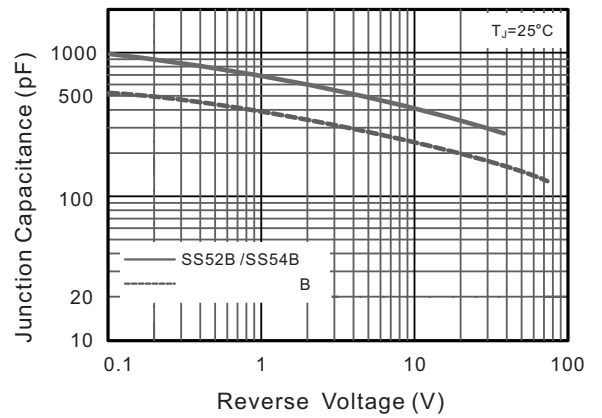

Fig.5 Maximum Non-Repetitive Peak Forward Surge Current

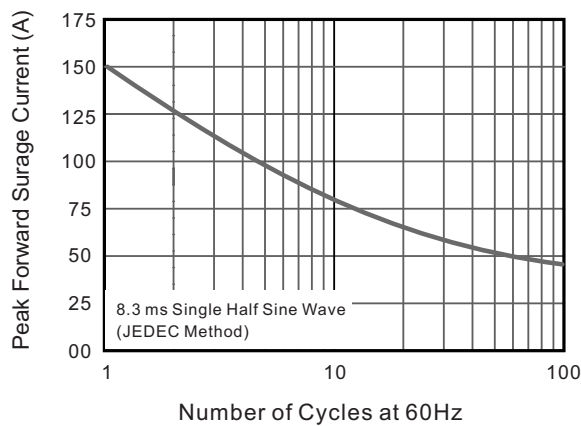
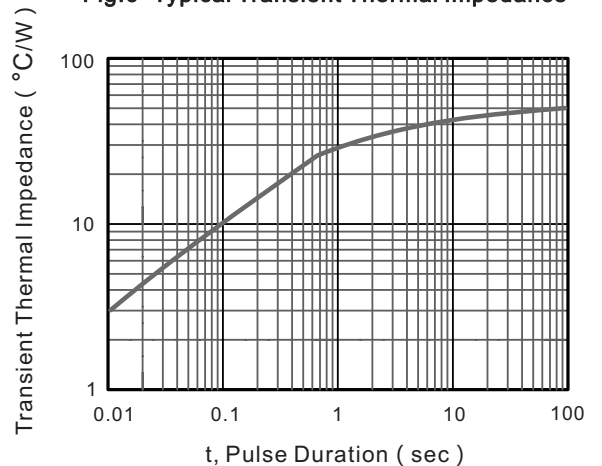
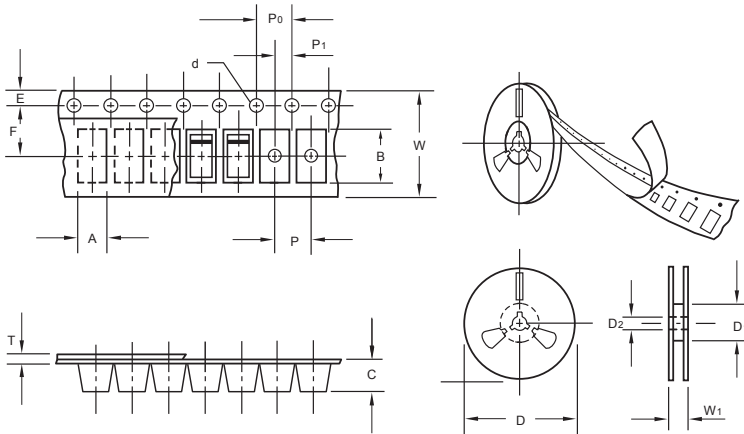

Fig.6- Typical Transient Thermal Impedance



The curve above is for reference only.

Packing information



unit:mm

| Item | Symbol | Tolerance | SMB |
|---------------------------|--------|-----------|--------|
| Carrier width | A | 0.1 | 3.81 |
| Carrier length | B | 0.1 | 5.41 |
| Carrier depth | C | 0.1 | 2.42 |
| Sprocket hole | d | 0.05 | 1.50 |
| 13" Reel outside diameter | D | 2.0 | 330.00 |
| 13" Reel inner diameter | D1 | min | 50.00 |
| Feed hole diameter | D2 | 0.5 | 13.00 |
| Sprocket hole position | E | 0.1 | 1.75 |
| Punch hole position | F | 0.1 | 5.55 |
| Punch hole pitch | P | 0.1 | 8.00 |
| Sprocket hole pitch | P0 | 0.1 | 4.00 |
| Embossment center | P1 | 0.1 | 2.00 |
| Overall tape thickness | T | 0.1 | 0.30 |
| Tape width | W | 0.3 | 12.00 |
| Reel width | W1 | 1.0 | 12.30 |

Note: Devices are packed in accordance with EIA standard RS-481-A and specifications listed above.

Reel packing

| PACKAGE | REEL SIZE | REEL (pcs) | COMPONENT SPACING (mm) | BOX (pcs) | INNER BOX (mm) | REEL DIA, (mm) | CARTON SIZE (mm) | CARTON (pcs) | APPROX. GROSS WEIGHT (kg) |
|---------|-----------|------------|------------------------|-----------|----------------|----------------|------------------|--------------|---------------------------|
| SMB | 13" | 3,000 | 4.0 | 6,000 | 190*190*41 | 330 | 365*365*360 | 48,000 | 14.0 |

Suggested Pad Layout

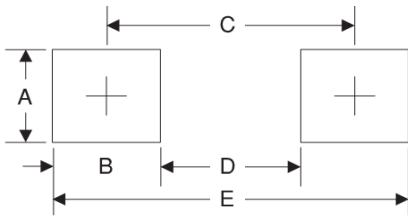

| Symbol | Unit (mm) | Unit (inch) |
|--------|-----------|-------------|
| A | 2.8 | 0.110 |
| B | 2.4 | 0.094 |
| C | 4.6 | 0.181 |
| D | 2.2 | 0.086 |
| E | 7.0 | 0.276 |