

Product Summary

$V_{(BR)DSS}$	$R_{DS(on)TYP}$	I_D
100V	1.2mΩ@10V	370A

Feature

- Fast Switching
- Low Gate Charge and Rdson
- Advanced Split Gate Trench Technology
- 100% Single Pulse avalanche energy Test

Applications

- PWM Application
- Hard switched and high frequency circuits
- Power Management

Package

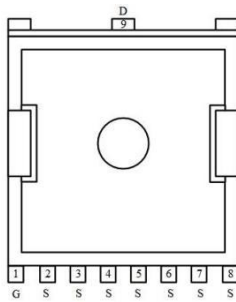

TOLL

Circuit diagram

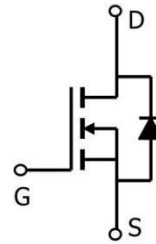

Marking

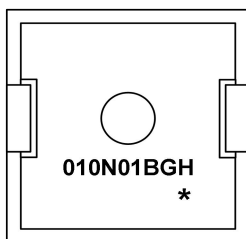

010N01BGH =Device Code
** =Week Code

Absolute maximum ratings (Ta=25°C, unless otherwise noted)

Parameter	Symbol	Rating	Units
Drain-Source Voltage	V_{DS}	100	V
Gate-Source Voltage	V_{GS}	± 20	V
Continuous Drain Current (Tc=25°C)	I_D	370	A
Pulsed Drain Current	I_{DM}	1480	A
Single Pulse Avalanche Energy ¹	E_{AS}	608	mJ
Total Power Dissipation ² (Tc=25°C)	P_D	410	W
Thermal Resistance Junction-Case	$R_{\theta JC}$	0.3	°C/W
Storage Temperature Range	T_{STG}	-55 to 150	°C
Operating Junction Temperature Range	T_J	-55 to 150	°C

Electrical characteristics (Ta=25°C, unless otherwise noted)

Parameter	Symbol	Conditions	Min.	Typ.	Max.	Unit
Static Characteristics						
Drain-Source Breakdown Voltage	BV_{DSS}	$V_{GS}=0V, I_D=250\mu A$	100	---	---	V
Drain-Source Leakage Current	I_{DSS}	$V_{DS}=80V, V_{GS}=0V, T_J=25^\circ C$	---	---	1	μA
Gate-Source Leakage Current	I_{GSS}	$V_{GS}=\pm 20V, V_{DS}=0V$	---	---	± 100	nA
Gate Threshold Voltage	$V_{GS(th)}$	$V_{GS}=V_{DS}, I_D=250\mu A$	2	3	4	V
Static Drain-Source On-Resistance	$R_{DS(on)}$	$V_{GS}=10V, I_D=125A$	---	1.2	1.5	m Ω
Dynamic characteristics						
Input Capacitance	C_{iss}	$V_{DS}=50V, V_{GS}=0V, f=1MHz$	---	14531	---	pF
Output Capacitance	C_{oss}		---	1959	---	
Reverse Transfer Capacitance	C_{rss}		---	82	---	
Switching Characteristics						
Total Gate Charge (4.5V)	Q_g	$V_{DS}=50V, V_{GS}=10V, I_D=125A$	---	208	---	nC
Gate-Source Charge	Q_{gs}		---	56	---	
Gate-Drain Charge	Q_{gd}		---	37	---	
Turn-On Delay Time	$T_{d(on)}$	$V_{DD}=50V, V_{GS}=10V, R_G=1.6\Omega, I_D=125A$	---	25	---	ns
Rise Time	T_r		---	75	---	
Turn-Off Delay Time	$T_{d(off)}$		---	89	---	
Fall Time	T_f		---	29	---	
Diode Characteristics						
Diode Forward Voltage ²	V_{SD}	$V_{GS}=0V, I_S=1A, T_J=25^\circ C$	---	---	1.2	V

Note :

- The EAS data shows Max. rating . The test condition is $V_{DD}=50V, V_{GS}=10V, L=0.5mH, R_G=25\Omega$
- The power dissipation is limited by 150°C junction temperature

Typical Characteristics

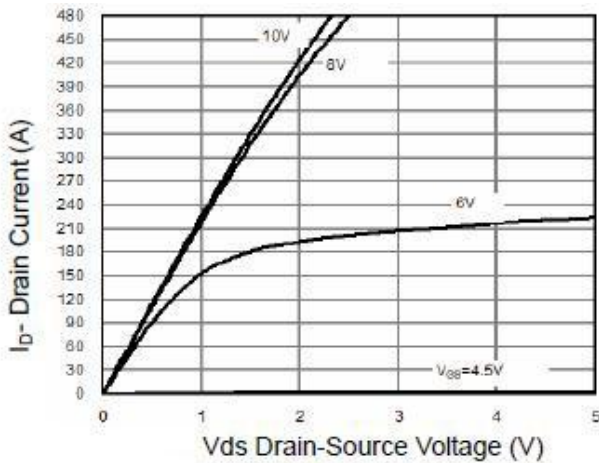

Output Characteristics

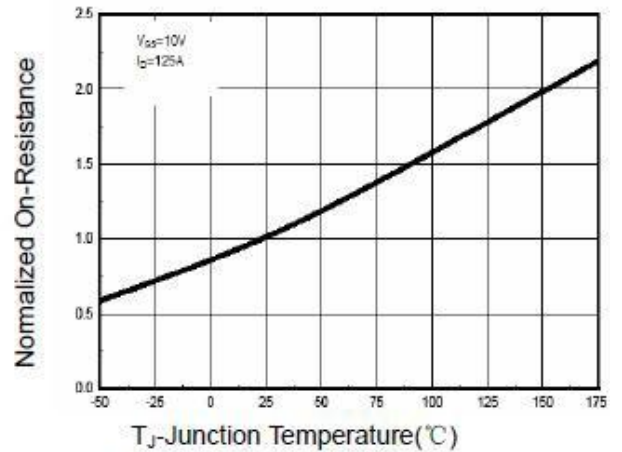

Rdson-Junction Temperature

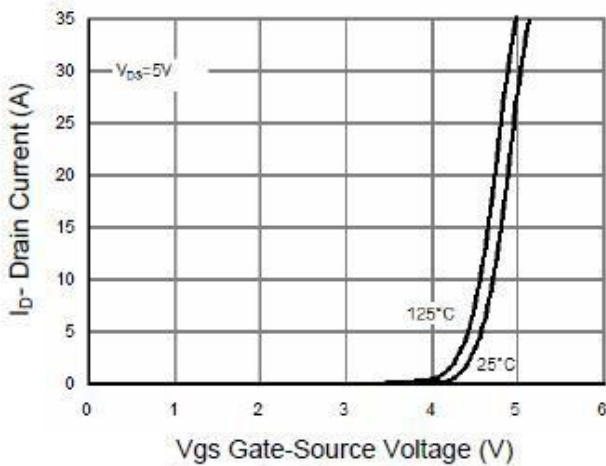

Transfer Characteristics

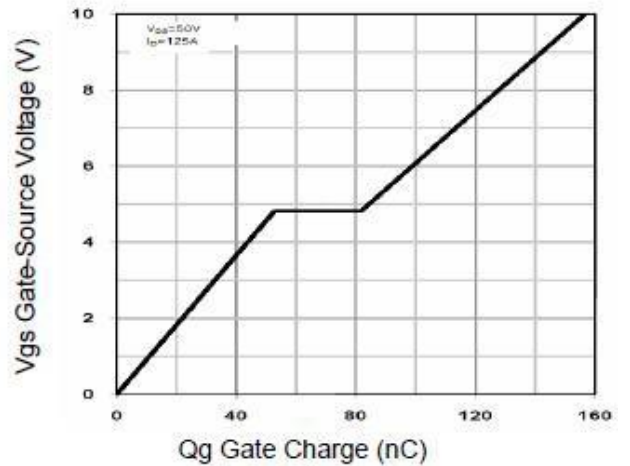

Gate Charge

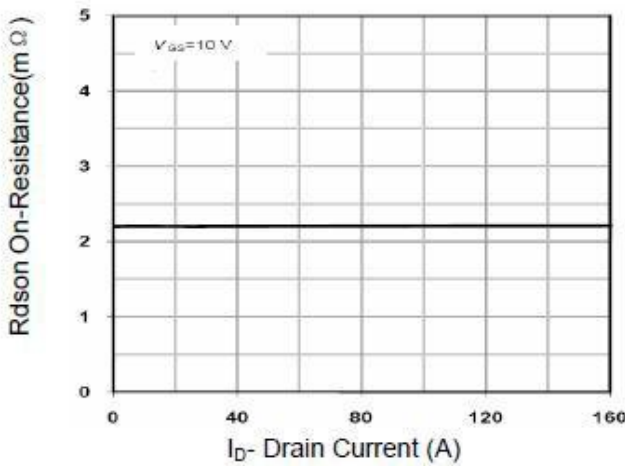

Rdson- Drain Current

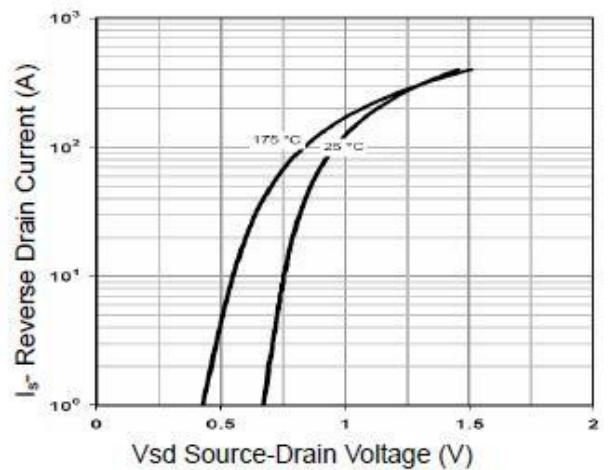

Source- Drain Diode Forward

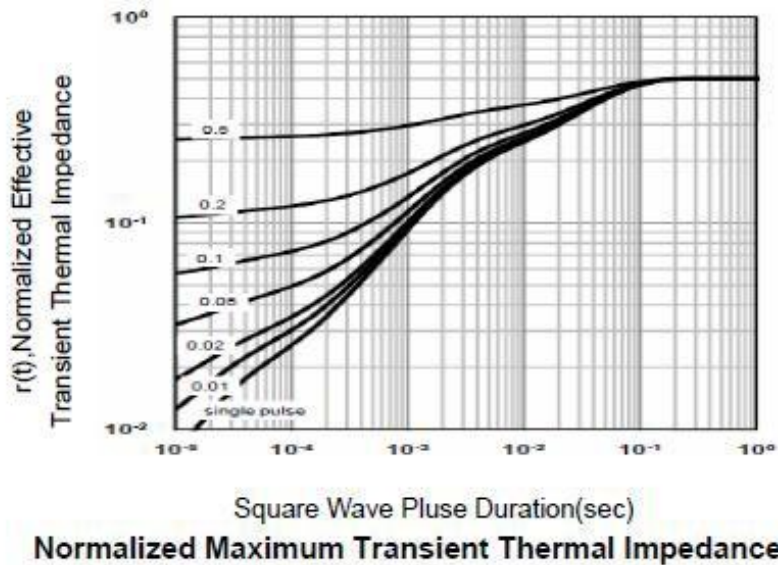
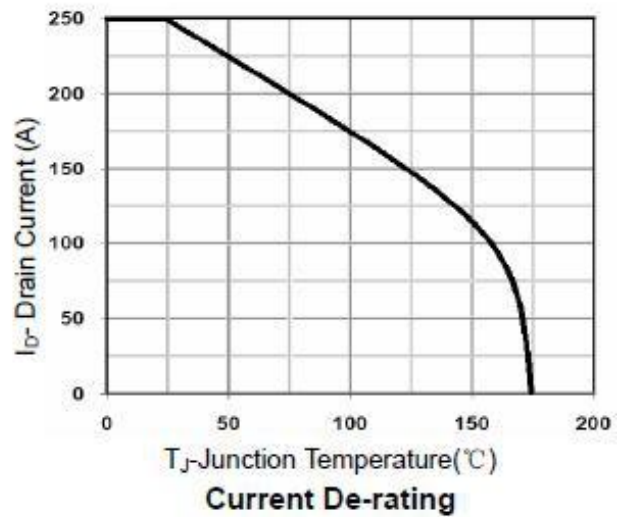
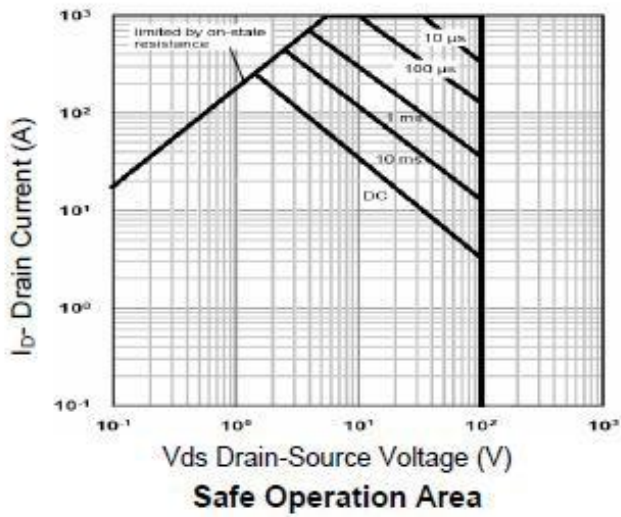
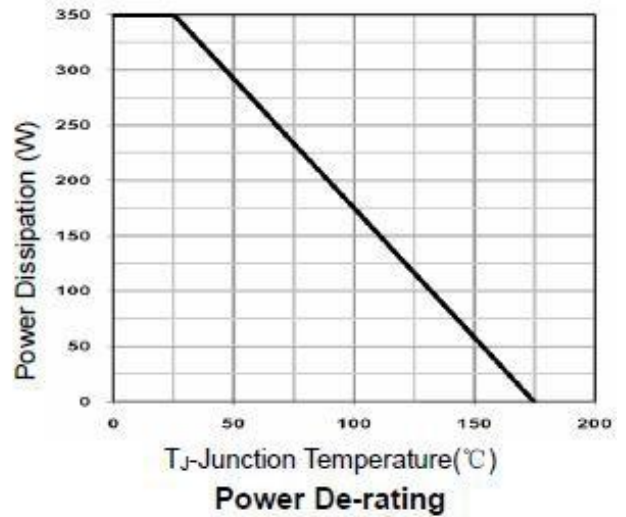
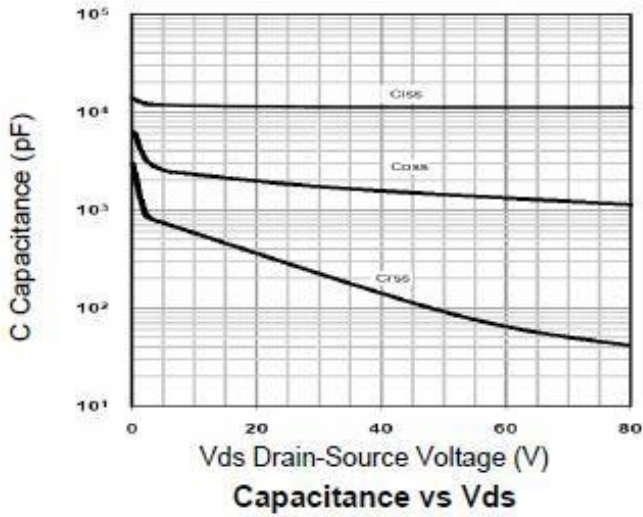



TOLL Package Information

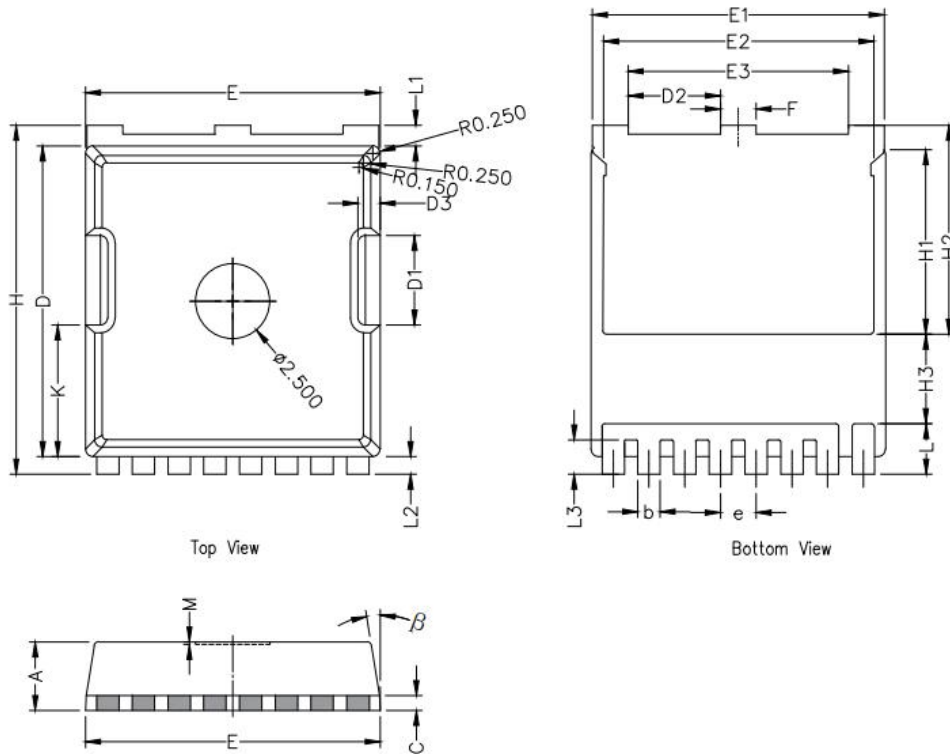

Symbol	Dimensions In Millimeters		
	Min.	Nom.	Max.
A	2.20	2.30	2.40
b	0.65	0.75	0.85
C	0.508 REF		
D	10.25	10.40	10.55
D1	2.85	3.00	3.15
E	9.75	9.90	10.05
E1	9.65	9.80	9.95
E2	8.95	9.10	9.25
E3	7.25	7.40	7.55
e	1.20 BSC		
F	1.05	1.20	1.35
H	11.55	11.70	11.85
H1	6.03	6.18	6.33
H2	6.85	7.00	7.15
H3	3.00 BSC		
L	1.55	1.70	1.85
L1	0.55	0.7	0.85
L2	0.45	0.6	0.75
M	0.08 REF.		
β	8°	10°	12°
K	4.25	4.40	4.55