

### Features

- Low operating voltage: 24V
- Ultra low capacitance: 40pF (Typ)
- Ultra low leakage: nA level
- Low clamping voltage
- -IEC 61000-4-2 (ESD) immunity test  
Air discharge:  $\pm 30\text{kV}$   
Contact discharge:  $\pm 30\text{kV}$
- -IEC61000-4-4 (EFT) 40A (5/50ns)
- -IEC61000-4-5 (Lightning) 8A (8/20 $\mu\text{s}$ )
- 2-pin leadless package
- These are Pb-Free Devices
- Response Time is Typically < 1 ns

### Mechanical Characteristics

- Package: SOD323(0805)
- Lead Finish: Matte Tin
- Case Material: "Green" Molding Compound
- Terminal Connections: See Diagram Below
- -IEC 61000-4-2 (ESD) immunity test

### Applications

- Cellular Handsets and Accessories
- Personal Digital Assistants
- Notebooks and Handhelds
- Portable Instrumentation
- Peripherals

### Dimensions and Pin Configuration

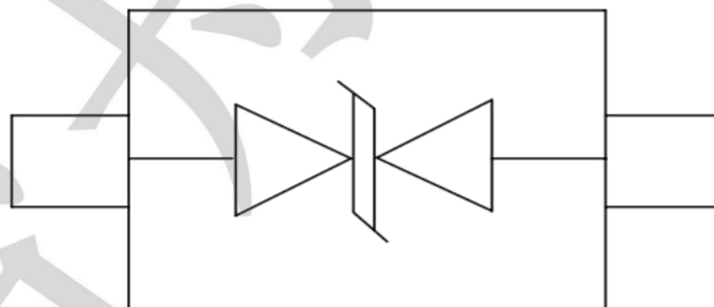

**Marking: 2H**

### Absolute Maximum Ratings (T<sub>amb</sub>=25°C unless otherwise specified)

Parameter	Symbol	Value	Unit
Peak Pulse Power (8/20μs)	Ppk	400	W
Peak Pulse Current (8/20μs)	Ipp	8	A
ESD per IEC 61000-4-2 (Air) ESD per IEC 61000-4-2 (Contact)	VESD	±30 ±30	KV
Operating Temperature Range	TJ	-55 to +125	°C
Storage Temperature Range	Tstg	-55 to +150	°C

### Electrical Characteristics (TA=25°C unless otherwise specified)

Parameter	Symbol	Min	Typ	Max	Unit	Test Condition
Reverse Working Voltage	VRWM	--	--	24	V	
Breakdown Voltage	VBR	26.7	28	31	V	IT= 1mA
Reverse Leakage Current	IR	--	--	1	uA	VRWM=24V
Clamping Voltage	VC	--	35	--	V	Ipp=1A(8x 20us pulse)
Clamping Voltage	VC	--	40	45	V	Ipp=8A(8x 20us pulse)
Junction Capacitance	CJ	--	40	70	pF	VR = 0V, f = 1MHz

### Characteristic Curves

Fig1. 8/20 $\mu$ s Pulse Waveform

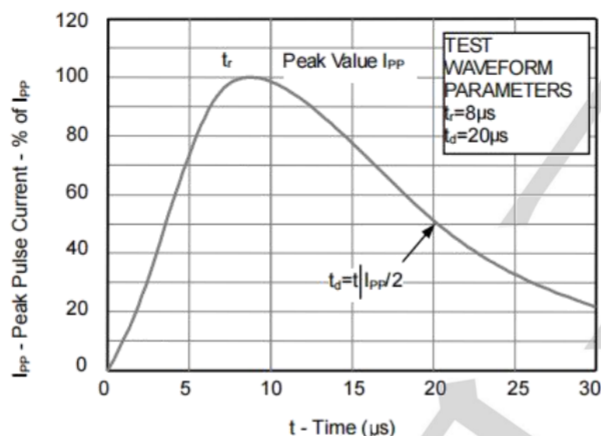

Fig2. ESD Pulse Waveform (according to IEC 61000-4-2)

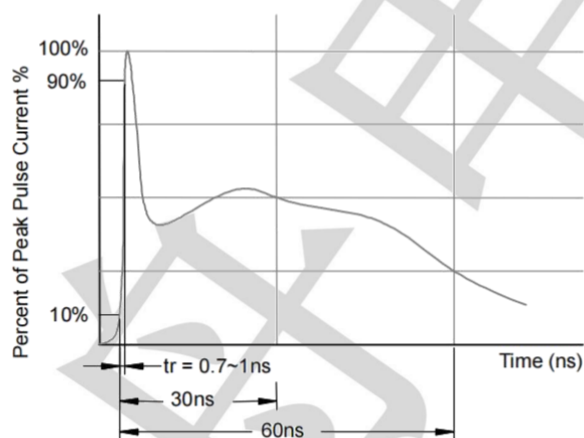
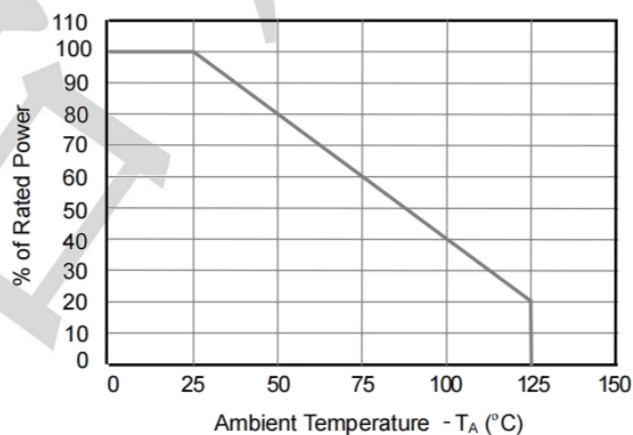
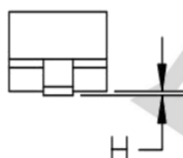
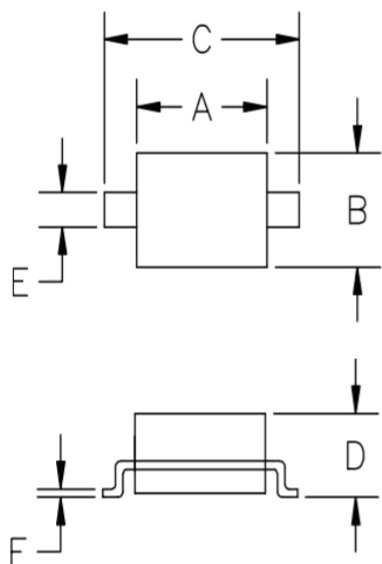

Fig3. Power Derating Curve



### Package Outline & Dimensions

SOD323 (0805)



DIMENSIONS				
SYM	MILLIMETERS		INCHES	
	MIN	MAX	MIN	MAX
A	1.50	1.80	0.060	0.071
B	1.20	1.40	0.045	0.054
C	2.30	2.70	0.090	0.107
D	-	1.10	-	0.043
E	0.30	0.40	0.012	0.016
F	0.10	0.25	0.004	0.010
H	-	0.10	-	0.004

### Suggested Land Pattern

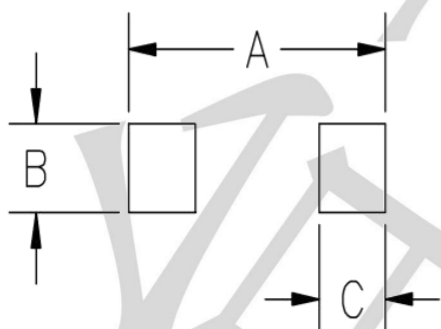

SYM	DIMENSIONS	
	MILLIMETERS	INCHES
A	3.15	0.120
B	0.80	0.031
C	0.80	0.031