

深圳市晶科鑫实业有限公司

样品承认书

客户代码:	
物料名称:	贴片钟振
规格型号:	3225 OSC 18.432MHZ 3.3V 15PF CMOS -40~+80℃
P N/ SJK:	3N18432G33YC

承 认 签 章					
供 应 商 承 认			() 公 司 承 认		
制 定	审 核	核 准	工 程 师	审 核	批 准
林雁	杨霞				
盖章签署			盖章签署		
日 期			日 期		
批示: <input type="checkbox"/> 接受 <input type="checkbox"/> 有条件接受					
备注:					

公司地址: 深圳市龙岗区天安云谷产业园一期3栋C座12楼1204~1206室

电 话: 0755-88352810-837 传 真: 0755-88353718

Approved by: 黄灏东
Checked by: 杨霞
Issued by: 玉静霞

产品规格书

SPECIFICATION

PN / SJK: **3N18432G33YC**

深圳市晶科鑫实业有限公司

SHENZHEN CRYSTAL TECHNOLOGY INDUSTRIAL CO., LTD.

公司地址: 深圳市龙岗区天安云谷产业园一期3栋C座12楼1204~1206室

电 话: 0755-88352810-837 传 真: 0755-88353718

修 改 记 录					
版次	修改日	项目	改定内容	改定者	确认者
A1	2015-6-5		初版	林雁	杨霞

CRYSTAL OSCILLATOR



SERIES 3N, SEAM SEALED CERAMIC 3.2X2.5MM SURFACE MOUNT PACKAGE

1. ELECTRICAL SPECIFICATIONS

Standard atmospheric conditions

Unless otherwise specified, the standard range of atmospheric conditions for making measurement and tests are as follow:

Ambient temperature : 25±5°C

Relative humidity : 40%~70%

If there is any doubt about the results, measurement shall be made within the following limits:

Ambient temperature : 25±3°C

Relative humidity : 40%~70%

Measure equipment

Electrical characteristics measured by MD 37WX-05M or equivalent.

Crystal cutting type

The crystal is using AT CUT (thickness shear mode).

	Parameters	SYM	Electrical Spec.				Notes	
			MIN	TYPE	MAX	UNITS		
1	Nominal Frequency		18.432000			MHZ		
2	Frequency Stability		AT 25°C			±10	PPM	
			Over Operating Temperature range			±20	PPM	
3	Operating Temperature	Topr	-40	25	85	°C		
4	Storage Temperature	Tstg	-55	~	125	°C		
5	Supply Voltage	VDD	3.3 ±10%			V		
6	Input Current	Icc			5	mA		
7	Enable Control		Yes				Pad1	
8	Output Load : CMOS	CL	15			pF		
9	Output Voltage High	VoH	90% Vdd			V		
10	Output Voltage Low	VoL			10% Vdd	V		
11	Rise Time	Tr			5	ns	10%→ 90%VDD Level	
12	Fall Time	Tf			5	ns	90%→ 10%VDD Level	
13	Symmetry (Duty ratio)	TH/T	45	~	55	%		
14	Start-up Time	Tosc			10	ms		
15	Enable Voltage High	Vhi	70% Vdd			V		
16	Disable Voltage Low	Vlo			30% Vdd	V		
17	Aging		±3			ppm/yr.	1st. Year at 25°C	
18	Output Disable Delay Time	T off			150	us		
19	Output Enable Delay Time	T on			150	us		
20	Phase Jitter (12KHZ~20MHZ)			0.5	1.0	ps		

CRYSTAL OSCILLATOR



SERIES 3N, SEAM SEALED CERAMIC 3.2X2.5MM SURFACE MOUNT PACKAGE

2. DIMENSIONS (Units :mm)

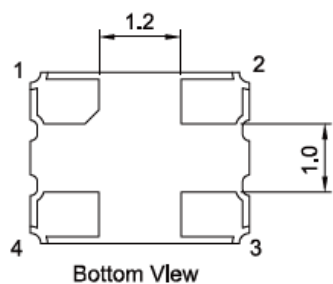
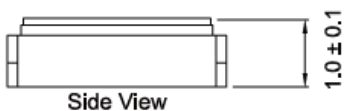
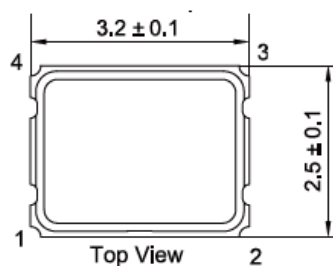

PAD FUNCTION:
 1: ENABLE CONTROL
 2: GND
 3: OUT
 4: VDD

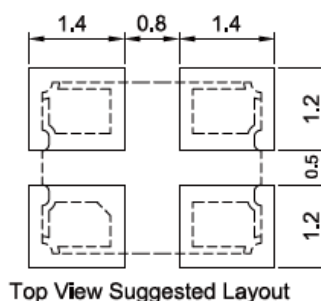

MARKING

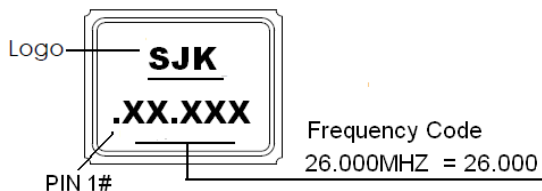

3. TEST CIRCUIT

Control input (output enable/disable)
 Logic 1 or open on pad 1: Oscillator output

Logic 0 on pad 1 : Disable output to high impedance

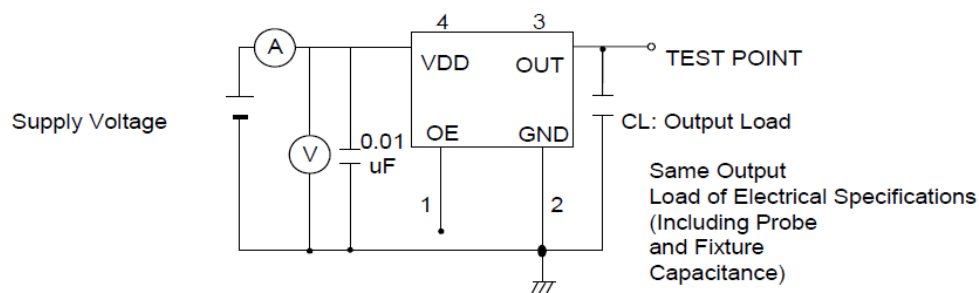

4. PART NUMBER GUIDE

CRYSTAL OSCILLATOR



SERIES 3N, SEAM SEALED CERAMIC 3.2X2.5MM SURFACE MOUNT PACKAGE

SJK -	3N	18432 Frequency 18.432MHz	G Frequency tolerance G:±30ppm	33 Supply voltage 33:3.3V	Y Fan out type X:TTL/CMOS Y:CMOS Z:TTL	C Temperature range C: -40-85°C
-------	----	---------------------------------	---	------------------------------------	--	--

5. WAVEFORM CONDITIONS

Waveform measurement system should have a min. bandwidth of 5 times the frequency being tested.

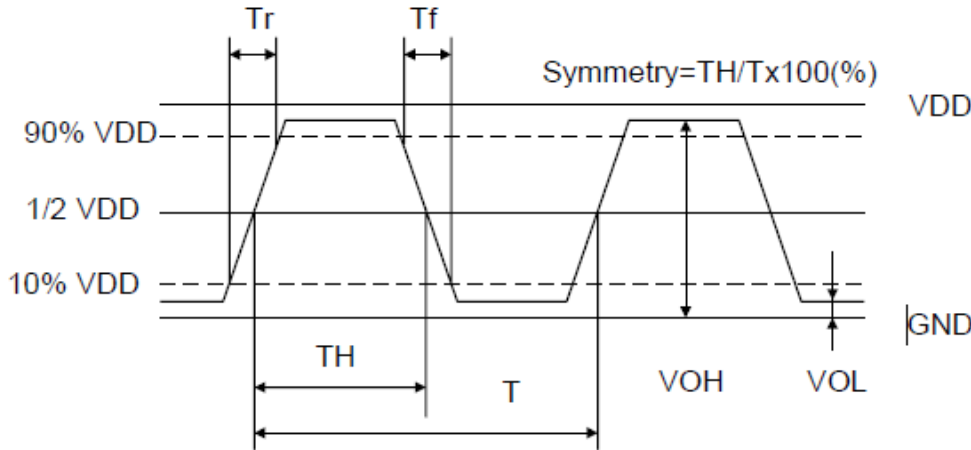

6. OUTPUT ENABLE / DISABLE DELAY

The following figure shows the oscillator timing during normal operation. Note that when the device is in standby, the oscillator stops. When standby is released, the oscillator starts and stable oscillator output occurs after a short delay.

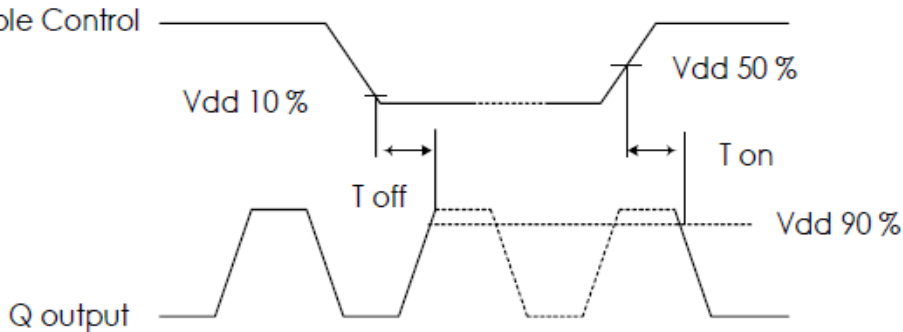

7. SUGGESTED REFLOW PROFILE

CRYSTAL OSCILLATOR



SERIES 3N, SEAM SEALED CERAMIC 3.2X2.5MM SURFACE MOUNT PACKAGE

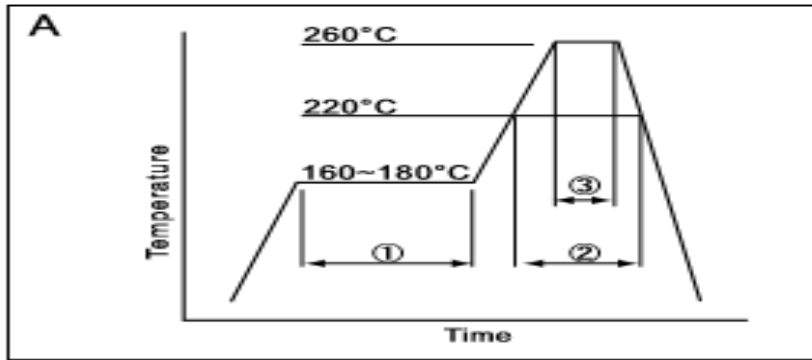

①	Preheat	160~180°C	120sec.
②	Primary heat	220°C	60sec.
③	Peak	260°C	10sec. max

Total time : 200 sec. Max / Solder melting point :220 °C

8. STRUCTURE ILLUSTRATION

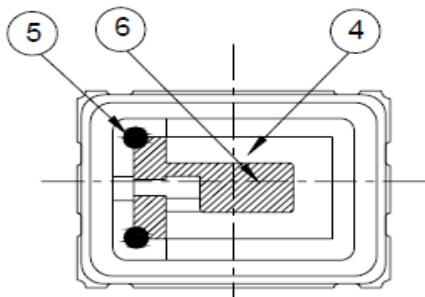

A-A' sectional drawing

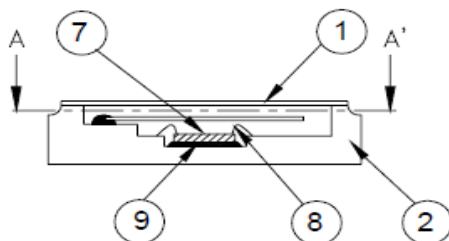

B-B' sectional drawing

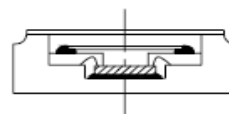

C-C' sectional drawing

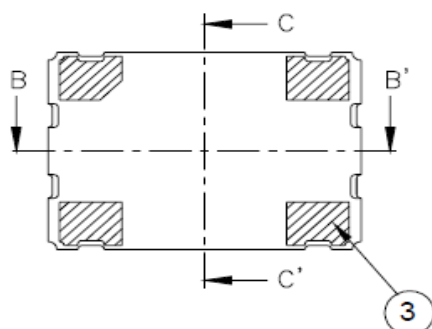

NO	COMPONENTS	MATERIALS	FINISH/SPECIFICATIONS
1	LID	Kovar (Fe/Co/Ni)	

CRYSTAL OSCILLATOR



SERIES 3N, SEAM SEALED CERAMIC 3.2X2.5MM SURFACE MOUNT PACKAGE

2	Base(Package)	Ceramic (Al ₂ O ₃) + Kovar (Fe/Co/Ni)+ Ag/Cu	Color black
3	PAD	Au	Tungsten metalize + Ni plating + Au plating
4	Crystal blank	SiO ₂	
5	Conductive adhesive	Ag	Silicon resin
6	Electrode	Noble Metal	
7	IC chip		
8	Bonding wire	Au	Pad 1 options : NC is 5 wires , EN is 6 wires.
9	Die attached	Conductive (Ag)	Epoxy resin

9. PACKING

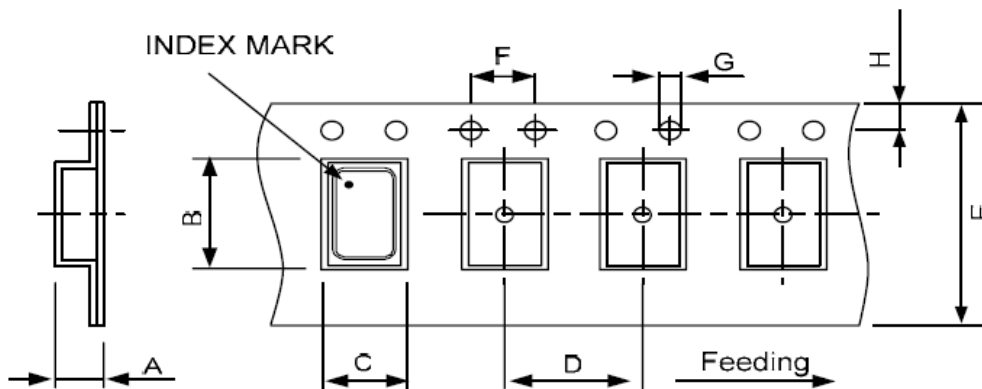

DIMENSIONS	A	B	C	D	E	F	G	H	(UNIT : mm)
	2.30	7.90	5.45	8.00	16.00	4.00	1.50	1.75	

REMARK :

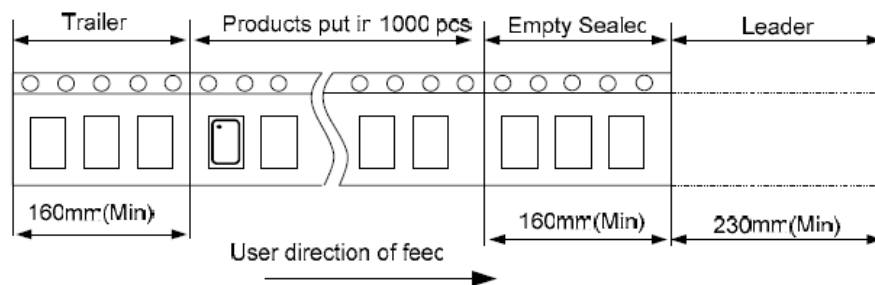

CRYSTAL OSCILLATOR



SERIES 3N, SEAM SEALED CERAMIC 3.2X2.5MM SURFACE MOUNT PACKAGE

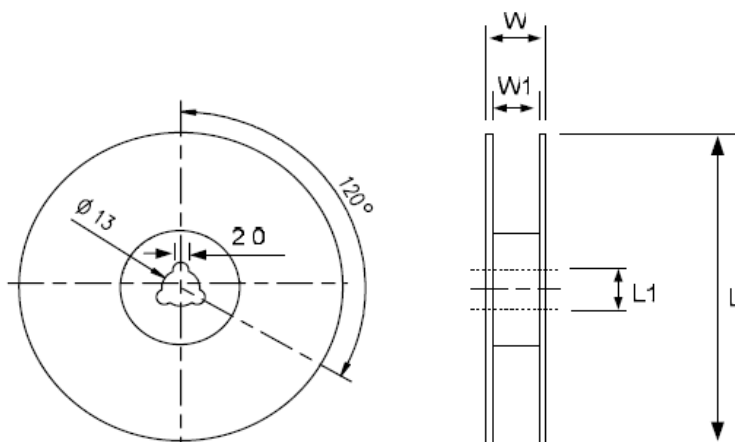

DIMENSIONS	L	L1	W	W1	pcs / Reel (UNIT : mm)
	180	13	20.5	16	Standard Reel Quantity is 1,000 pcs per reel

10. RELIABILITY TEST SPECIFICATION

1. Mechanical Endurance

No.	Test Item	Test Methods	REF. DOC
1	Drop Test	75 cm height, 3 times on concrete floor .	JIS C6701
2	Mechanical Shock	Device are shocked to half sine wave (1000 G) three mutually perpendicular axes each 3 times. 0.5m sec. duration time	MIL-STD-202F
3	Vibration	Frequency range 10 ~ 2000 Hz Amplitude 1.52 mm/20G Sweep time 20 minutes Perpendicular axes each test time 4 Hrs (Total test time 12 Hrs)	MIL-STD-883E
4	Gross Leak	Standard Sample For Automatic Gross Leak Detector, Test Pressure: 2kg / cm ²	MIL-STD-883E
5	Fine Leak	Helium Bomging 4.5 kgf / cm ² for 2 Hrs	
6	Solderability	Temperature 245 °C ± 5°C Immersing depth 0.5 mm minimum Immersion time 5 ± 1 seconds Flux Rosin resin methyl alcohol solvent (1 : 4)	MIL-STD-883E

2. Environmental Endurance

No.	Test Item	Test Methods	REF. DOC
1	Resistance To Soldering Heat	Pre-heat temperature 125 °C Pre-heat time 60 ~ 120 sec. Test temperature 260 ± 5 °C Test time 10 ± 1 sec.	MIL-STD-202F

CRYSTAL OSCILLATOR



SERIES 3N, SEAM SEALED CERAMIC 3.2X2.5MM SURFACE MOUNT PACKAGE

2	High Temp. Storage	+ 125 °C ± 3 °C for 1000 ± 12 Hrs	MIL-STD-883E
3	Low Temp. Storage	- 40 °C ± 3 °C for 1000 ± 12 Hrs	
4	Thermal Shock	<p>Total 100 cycles of the following temperature cycle</p> <p>The diagram shows a temperature cycle starting at 125 ± 3 °C, dropping to a dwell at 25 °C, then to -55 ± 3 °C. The dwell at -55 °C is labeled '10 mir max'. The total cycle duration is '10 mir'.</p>	MIL-STD-883E
5	Pressure Cooker Storage	121 ± 3 °C , RH100% , 2 bar , 240 Hrs	JIS C6701
6	High Temp & Humidity	85 °C ± 3 °C , RH 85% , 1000 Hrs	JIS C5023